



# PRODUCT RESOURCE GUIDE 2023

**UNILOCK®**

# Calculate

paver and  
wall projects  
**FASTER!**

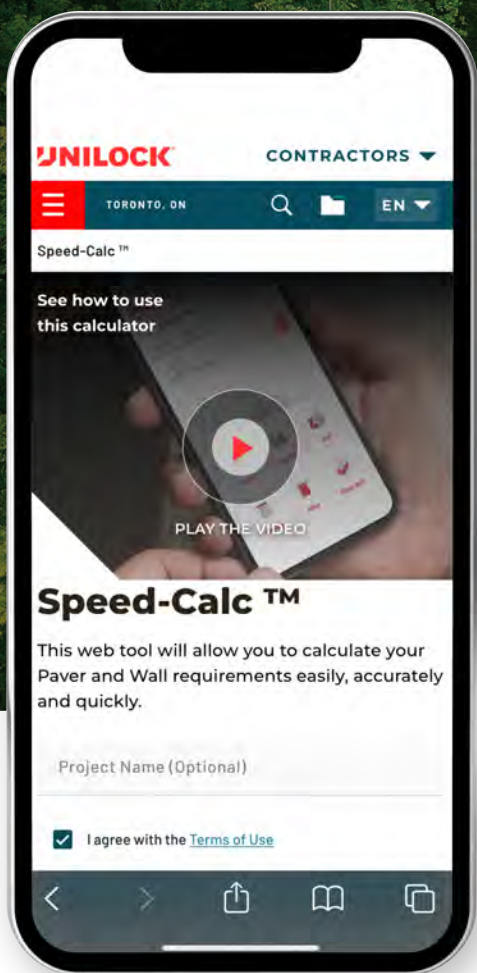

Email  
directly  
to your  
Unilock  
Dealer



Try **SPEED-CALC™**  
by **UNILOCK®**





## PAVERS

	PAGE
Artline™	6
Beacon Hill™ Flagstone 60mm	8
Beacon Hill™ Flagstone 80mm	10
Beacon Hill™ Smooth 60mm	12
Beacon Hill™ Smooth 80mm	14
Bristol Valley® 60mm	16
Bristol Valley® 80mm	18
Bronte® Street Paver	20
Brussels Block®	22
Copthorne®	24
Courtstone®	26
Dura-Flow®	28
Dura-Mat	30
Eco-Line®	32
Eco-Optiloc™	34
Eco-Priora™	36
Eco-Promenade®	38
Granito™	40
Granito™ Mix	42
Hollandstone™ / Double Holland	44
Il Campo®	46
Load Lock	48
Mattoni™	50
Nordic Cobble™	52
Northshore™	54
Optiloc™	56
Promenade Plank™	58
Revela™	60
Richcliff®	62
Series™ 70mm	64
Series™ 100mm	66
Town Hall®	68
Treo® Smooth	70
Tribeca Cobble™	72
Turfstone™	74
Umbriano® 60mm	76
Umbriano® 70mm	78
Umbriano® 80mm	80
Umbriano® 100mm	82
Westport™ Smooth	84
Windermere® Flagstone	86
Windermere® Smooth	88



## SLABS

	PAGE
Arcana™ Slab	92
Beacon Hill™ Smooth Slab	94
Metro Slab™	96
Promenade Plank™ Slab	98
Revela™ Slab	100
Skyline™ Slab	102
Soreno™ Slab	104
Umbriano® Slab	106
Urban Line Slab	108
<b>Natural Stone Slabs</b>	
Bucine Bluestone (Sandstone)	110
Black River (Limestone)	112
Greyfield (Sandstone)	114
Indian Coast (Sandstone)	116
Ivory Sand (Sandstone)	118
Stone Cliff Grey (Sandstone)	120
<b>Porcelain Tile Slabs</b>	122-127
<b>Granite Slabs</b>	
Black Oyster	128
Castle Grey	130
Galaxy Frost	132



## RETAINING WALLS AND VERTICALS

	PAGE
Brussels Dimensional Stone®	136
DuraHold®	138
DuraHold2®	140
Lineo™ Dimensional Stone	142
Pisa	144
Pisa Smooth™	146
SienaStone™	148
SienaStone™ Smooth	150
SonomaStone™	152
U-CARA®	154-157
U-CARA® Modular System	158
U-CARA® Wall Mount System	159



## STEPS, TREADS & COPING

	PAGE
Brussels Fullnose™	162
Endura™ Coping	163
Ledgestone™ Pillar Caps & Coping	164
Pisa Coping	166
Pisa Smooth™ Coping	167
Umbriano® Coping	168
Universal Coping	169
Urban Line Coping	170
Natural Stone (Limestone) Coping	171
Natural Stone (Sandstone) Coping	172
Natural Stone Pillar Caps & Coping (Bucine Bluestone)	173
Ledgestone™ Steps	175
SienaStone™ Steps	176
SienaStone™ Smooth Steps	177
Natural Stone (Limestone) Steps	178
Natural Stone (Sandstone) Steps	179
Natural Stone Steps (Bucine Bluestone)	180

## ACCESSORIES / PRODUCT & INSTALLATION INFO

	PAGE
Fire Pits	184
Unilock Elements	185
DRIVECEL™	186-187
DRIVEGRID™	188-189
Sealers/Cleaners/Edging/Adhesives	190-191
Romex® - Rompox® Sands	192-193
Romex® - The Sand Solution	194-199
Alliance Gator Sands & Accessories	200-201
Ardex Natural Stone Grouts	202
Accessories	203
Alliance Gator Base System	204
Bedding Materials/Base Depth Charts	205

## THINGS TO KNOW

	PAGE
Charts & Calculations	208
Sealer & Polysand Best Practices	209
Important Notes	210
Finishes & Colour Blends	211
Product Directory	212-213
Paver Reference Guide	214
Wall/Steps/Coping Reference Guide	215
Leed Credit Opportunities & SRI info	216

### IMPORTANT NOTES:

- \*All measurements are published as D x W x H.
- \*All imperial measurements are approximate conversions only.
- \*Colour selection should be chosen from actual samples.



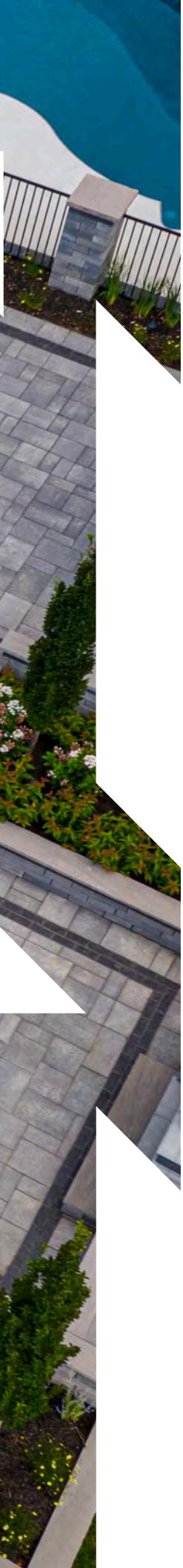

UNILOCK® COLLECTION OF

# Pavers

From traditional shapes and textures to the most advanced technology and unique styles, the choices available in our paver collection are unrivaled in the industry.

**Pavers:** Umbriano® (French Grey) with Town Hall® (Basalt) accent

**Walls:** Lineo Dimensional Stone™ (Granite Blend) with Lineo Dimensional Stone™ (Midnight Charcoal) accent

**Steps & Coping:** Natural Stone (Stone Cliff Grey)



# ARTLINE™

## ENDURACOLOR™

FOSSIL **NEW**

GRANITE MIST

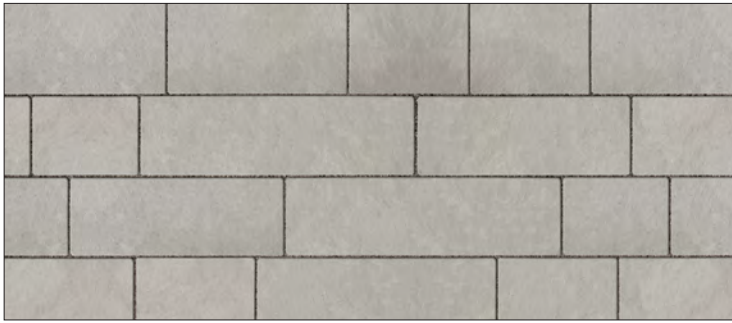
STERLING **NEW**

### VISUAL APPEARANCE

The long, clean lines of Artline™ reflect an emerging trend to modern, linear outdoor designs. The product is sold in a random bundle of seven different rectangular shapes in two widths and varying lengths.

### FINISH

Artline™ uses EnduraColor™ technology for a refined surface with long lasting colour and some even have EasyClean™, an integral surface protection from stains. These finishes can be used separately for a cohesive look, or combined together to create colour and textural interest.

### PRODUCT SPECIFICATIONS

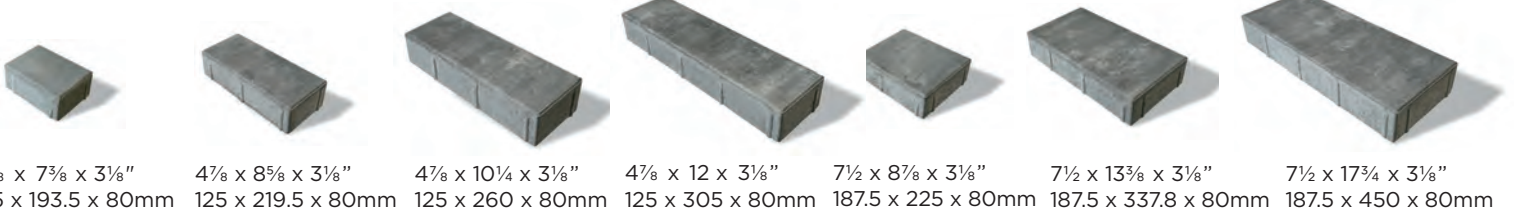

7 UNIT RANDOM BUNDLE

### EDGE DETAILS



MICRO BEVEL

### BUNDLE CONFIGURATION

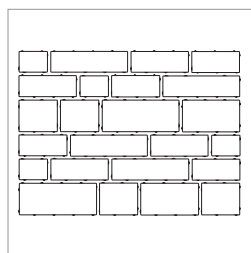

### LAYING PATTERNS



\*Colour selection should be chosen from actual samples.

**TECHNICAL INFORMATION**

**ASTM C 936 Standard Specifications for Solid Concrete Interlocking Paving Units**

Conforms to:

- C140 for Absorption 5% avg - 7% max
- C140 for Compressive Strength > 7,200 PSI avg.
- C1645 for Freeze-thaw Durability
- C418 for Abrasion Durability
- Dimensional Accuracy **+/- 3 mm**

*Test results available upon request*

**Meets the U.S. Architectural & Transportation Barrier Compliance Board Slip-Resistance Surfaces Advisory Guidelines**

**LEED INFORMATION**

**Materials & Resources: LEED V4:**

- Building Product Disclosure and Optimization
- Sourcing of Raw Materials - Sourcing of Raw Materials and Extraction • **1 point**
- Sourcing of Raw Materials - Leadership Extraction Practices • **1 point**
- Material Ingredient Reporting - Material Ingredient Reporting • **1 point**
- Material Ingredient Reporting - Material Ingredient Optimization • **1 point**
- Environmental Product Declaration • **1 point**

**TECHNICAL ADVANTAGES**

**ENDURACOLOR™**

Refined surface and long-lasting colour

**DRIVE FRIENDLY**

Can handle vehicular loads  
*Ask about our base stabilization system*

**PRODUCT DATA**

Stones & Bundling	Unit Thickness	SqFt Per				Per Bundle		Soldier LnFt Per			Sailor LnFt per			Units Per			Lbs Per		
		Bundle	Layer	Section	Stone	Layers	Sections	Unit	Section	Bundle	Unit	Section	Bundle	SqFt	Section	Bundle	Layer	Section	Bundle
<b>Pickering Manufacturing / Granite Fusion stocked in Ayr</b>																			
Random Bundle		81.60	11.66	-	1.00	7	-	-	-	-	-	-	-	2.4	-	196	426.61	-	2,986.27
Large 12.5	3 1/8" (80mm)	-	-	-	0.35	-	-	-	-	-	-	-	-	2.20	-	32	-	-	-
Large 18.75	3 1/8" (80mm)	-	-	-	0.91	-	-	-	-	-	-	-	-	1.10	-	16	-	-	-
Medium 12.5	3 1/8" (80mm)	-	-	-	0.29	-	-	-	-	-	-	-	-	2.83	-	32	-	-	-
Medium 18.75	3 1/8" (80mm)	-	-	-	0.68	-	-	-	-	-	-	-	-	1.47	-	16	-	-	-
Small 12.5	3 1/8" (80mm)	-	-	-	0.23	-	-	-	-	-	-	-	-	4.40	-	32	-	-	-
Small 18.75	3 1/8" (80mm)	-	-	-	0.45	-	-	-	-	-	-	-	-	2.20	-	32	-	-	-
X-Large 12.5	3 1/8" (80mm)	-	-	-	0.41	-	-	-	-	-	-	-	-	1.65	-	32	-	-	-
Random Bundle	4" (100mm)	58.25	11.65	-	-	-	-	-	-	-	-	-	-	-	-	-	533.16	-	2,665.81

Notes: Product sold in full bundles only on a refundable skid. All measurements are nominal.

**Important: A urethane rubber paver mat must be used to prevent scuffing.** For more information, samples or custom options, please contact your Unilock Territory Manager or call 1-800-UNILOCK.

**APPLICATIONS**



Pedestrian



Residential Vehicular



Roof Deck

**RECOMMENDED SANDS**

**RECOMMENDED SEALER**



+



**Romex: Rompox® Fugensand**

**Pedestrian, Vehicular and Heavy Duty Vehicular Applications**

- Manufactured from natural, raw materials
- Allows for efficient stormwater management and more durable paver joint
- Quick application
- Self-repairing properties
- Suitable for all load classes
- No cement haze/residue due to natural polymer binders

Coverage:

Colour	3mm Joints
Neutral, Stone Grey, Basalt <i>1 L / 5 gal</i>	50-150 sqft / 55 lb bag

**Romex: Rompox® D7000 Joint Strengthener & Surface Sealer**

**Pedestrian, Vehicular and Heavy Duty Vehicular Applications**

- All-in-one strengthener & sealer
- Eco-Friendly
- Protects against dirt, oil, corrosion from climate exposure, de-icing salts
- Protects against weed growth and wash outs
- Allows for light surface pressure washing once cured

Coverage:

Colour	3-4mm Joints
Neutral, Stone Grey, Basalt <i>55 lb bag / 1 kg can</i>	50-150 sqft / 55 lb mix

**Alliance - Gator G2 MAXX Sand**

- Rain safe after 15 minutes (24hr no rain if concrete overlay)
- Sets above 32° F/ 0° C - may vary depending on weather, drainage, bedding materials and installation
- Dust free and haze free
- Requires only one watering
- Four colours: Beige, Grey, Black and Ivory

Coverage:

Colour	Narrow Joints	Wide Joints
Beige, Grey, Ivory <i>50 lb bag</i>	65-85 sqft	22-42 sqft
Black <i>50 lb bag</i>	58-76 sqft	20-38 sqft

**Alliance - Gator Natural Look Sealer**

- Water-based
- Zero gloss finish
- Multi purpose
- Rain safe after 24 hours

Coverage:

Size	Area
3.78 L / 1 U.S. gal.	175 sqft
18.9 L. / 5.28 U.S. gal.	875 sqft

\*Please refer to Sands & Sealers on pages 190-202 for more detailed information.

Unsure of bonded vs. unbonded product recommendations? Please contact your Unilock Territory Manager for more information.

# BEACON HILL™ FLAGSTONE 60mm

ENDURACOLOR™



ALMOND GROVE FUSION



FOSSIL



GRANITE MIST



TUSCANY

44  
SRI

## VISUAL APPEARANCE

Gentle surface clefts and clean edges.

## FINISH

Flag/Riven finish.

## PRODUCT SPECIFICATIONS



**LARGE RECTANGLE**  
15 x 22½ x 2⅜"  
380 x 570 x 60 mm



**SQUARE**  
15 x 15 x 2⅜"  
380 x 380 x 60mm



**SMALL RECTANGLE**  
7½ x 15 x 2⅜"  
190 x 380 x 60mm

3 UNIT RANDOM BUNDLE

## EDGE DETAIL



ROUNDED EDGE

## BUNDLE CONFIGURATION



## LAYING PATTERNS

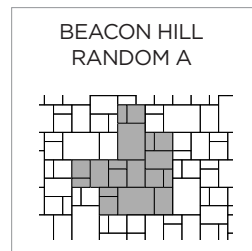

**BHF RANDOM A**  
40% Large Rectangle, 40%  
Square, 20% Small Rectangle

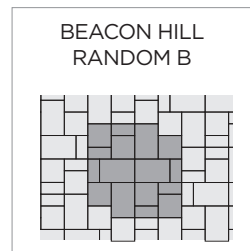

**BHF RANDOM B**  
40% Large Rectangle, 40%  
Square, 20% Small Rectangle

\*Colour selection should be chosen from actual samples.



**TECHNICAL INFORMATION**

**ASTM C936 Standard Specifications for Solid Concrete Interlocking Paving Units**

Conforms to:

- C140 for Absorption 4% avg - 5% max
- C140 for Compressive Strength > 8,000 PSI avg.
- C1645 for Freeze-thaw Durability
- C418 for Abrasion Durability
- Dimensional Accuracy **+/- 3mm**

*Test results available upon request*

**Meets the U.S. Architectural & Transportation Barrier Compliance Board Slip-Resistance Surfaces Advisory Guidelines**

**SOLAR REFLECTIVE INDEX (SRI) TESTING DETAILS**

Product	Solar Reflectance	SRI
Tuscany	0.39	44 

**LEED INFORMATION**

**Materials & Resources: LEED V4:**

- Building Product Disclosure and Optimization
- Sourcing of Raw Materials - Sourcing of Raw Materials and Extraction • **1 point**
- Sourcing of Raw Materials - Leadership Extraction Practices • **1 point**
- Material Ingredient Reporting - Material Ingredient Reporting • **1 point**
- Material Ingredient Reporting - Material Ingredient Optimization • **1 point**
- Environmental Product Declaration • **1 point**

**TECHNICAL ADVANTAGES**

**ENDURACOLOR™**

Refined surface and long-lasting colour

**PEDESTRIAN FRIENDLY**

Not recommended for vehicular

**PRODUCT DATA**

Stones & Bundling	Unit Thickness	SqFt Per				Per Bundle		Soldier LnFt Per			Sailor LnFt per			Units Per		Lbs Per		
		Bundle	Layer	Section	Stone	Layers	Sections	Unit	Layer	Bundle	Unit	Layer	Bundle	SqFt	Bundle	Layer	Section	Bundle
<b>Fossil and Granite Mist manufactured in Ayr / All other colours manufactured in Pickering</b>																		
Random Bundle		104.91	11.66	-	-	9	-	-	-	-	-	9.35	84.15	0.69	72	319.93	-	2,879.4
Large Rectangle	2 3/4" (60mm)	-	4.66	-	2.331	-	-	-	-	-	1.87	-	33.66	0.48	18	-	-	-
Small Rectangle	2 3/4" (60mm)	-	4.66	-	0.777	-	-	-	-	-	0.63	-	16.83	1.43	27	-	-	-
Square	2 3/4" (60mm)	-	2.33	-	1.554	-	-	-	-	-	1.25	-	33.66	0.72	27	-	-	-

Notes: Sold in full bundles only on a refundable skid. **Beacon Hill 60mm is not intended for vehicular applications.** All measurements are nominal. **Important: A urethane rubber paver mat must be used to prevent scuffing.** For more information, samples or custom options, please contact your Unilock Territory Manager or call 1-800-UNILOCK.

**APPLICATIONS**



Pedestrian



Roof Deck

**RECOMMENDED SANDS**



**Romex: Rompox™ ECO-Fine**  
Pedestrian Applications only  
Vehicular when laid on a Trass Bed

- | Ready mixed and easy to use
- | Resin film free
- | Resistant to ants, weeds, de-icing salts
- | Made from 98% natural, recycled or renewable raw materials
- | Pressure washer safe
- | Ideal for joint widths from 5mm (1/4")

**Coverage:**

Colour	5-6mm Joints
Beige, Stone Grey, Anthracite 55 lb bag / 1 kg can	125 sqft / 55 lb mix



**Alliance - Gator G2 MAXX Sand**

- | Rain safe after 15 minutes (24hr no rain if concrete overlay)
- | Sets above 32° F/ 0° C - may vary depending on weather, drainage, bedding materials and installation
- | Dust free and haze free
- | Requires only one watering

**Coverage:**

Colour	Narrow Joints	Wide Joints
Beige, Grey, Ivory 50 lb bag	65-85 sqft	22-42 sqft
Black 50 lb bag	58-76 sqft	20-38 sqft

**RECOMMENDED SEALER**



**Alliance - Gator Natural Look Sealer**

- | Water-based
- | Zero gloss finish
- | Multi purpose
- | Rain safe after 24 hours

**Coverage**

Size	Area
3.78 L / 1 U.S. gal.	175 sqft
18.9 L. / 5.28 U.S. gal.	875 sqft

\*Please refer to Sands & Sealers on pages 190-202 for more detailed information.

Unsure of bonded vs. unbonded product recommendations? Please contact your Unilock Territory Manager for more information.

# BEACON HILL™ FLAGSTONE 80mm



ENDURACOLOR™



ALMOND GROVE FUSION



FOSSIL



GRANITE MIST



TUSCANY

4.4  
SRI

## VISUAL APPEARANCE

Gentle surface clefts and clean edges.

## FINISH

Flag/Riven finish.

## PRODUCT SPECIFICATIONS



**LARGE RECTANGLE**  
15 x 22½ x 3⅛"  
380 x 570 x 80mm



**SQUARE**  
15 x 15 x 3⅛"  
380 x 380 x 80mm



**SMALL RECTANGLE**  
7½ x 15 x 3⅛"  
190 x 380 x 80mm

3 UNIT RANDOM BUNDLE

## EDGE DETAIL



ROUNDED EDGE

## BUNDLE CONFIGURATION



## LAYING PATTERNS

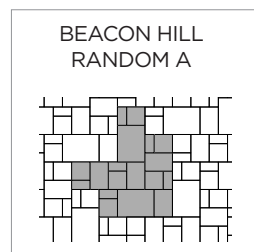

**BHF RANDOM A**  
40% Large Rectangle, 40%  
Square, 20% Small Rectangle

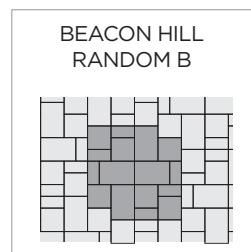

**BHF RANDOM B**  
40% Large Rectangle, 40%  
Square, 20% Small Rectangle

\*Colour selection should be chosen from actual samples.

**TECHNICAL INFORMATION**

**ASTM C936 Standard Specifications for Solid Concrete Interlocking Paving Units**

- Conforms to:
- C140 for Absorption 4% avg - 5% max
  - C140 for Compressive Strength > 8,000 PSI avg.
  - C1645 for Freeze-thaw Durability
  - C418 for Abrasion Durability
  - Dimensional Accuracy **+/- 3mm**
- Test results available upon request*

**Meets the U.S. Architectural & Transportation Barrier Compliance Board Slip-Resistance Surfaces Advisory Guidelines**

**SOLAR REFLECTIVE INDEX (SRI) TESTING DETAILS**

Product	Solar Reflectance	SRI
Tuscany	0.39	44 

**LEED INFORMATION**

- Materials & Resources: LEED V4:**
- Building Product Disclosure and Optimization
  - Sourcing of Raw Materials - Sourcing of Raw Materials and Extraction • **1 point**
  - Sourcing of Raw Materials - Leadership Extraction Practices • **1 point**
  - Material Ingredient Reporting - Material Ingredient Reporting • **1 point**
  - Material Ingredient Reporting - Material Ingredient Optimization • **1 point**
  - Environmental Product Declaration • **1 point**

**TECHNICAL ADVANTAGES**

**ENDURACOLOR™**

Refined surface and long-lasting colour

**DRIVE FRIENDLY**

80mm pavers can handle vehicular loads  
*Ask about our base stabilization system*





**PRODUCT DATA**

Stones & Bundling	Unit Thickness	SqFt Per				Per Bundle		Soldier LnFt Per			Sailor LnFt per			Units Per		Lbs Per		
		Bundle	Layer	Section	Stone	Layers	Sections	Unit	Section	Bundle	Unit	Layer	Bundle	SqFt	Bundle	Layer	Layer	Bundle
<b>Fossil and Granite Mist manufactured in Ayr / All other colours manufactured in Pickering</b>																		
Random Bundle		81.60	11.65	-	-	7	-	-	-	-	-	8.86	65.20	0.69	56	426.59	-	2,986.1
Large Rectangle	3 3/8" (80mm)	-	4.66	-	2.33	-	-	-	-	-	1.87	-	26.25	0.48	14	-	-	-
Small Rectangle	3 3/8" (80mm)	-	2.33	-	0.77	-	-	-	-	-	0.63	-	13.23	1.29	21	-	-	-
Square	3 3/8" (80mm)	-	4.66	-	1.55	-	-	-	-	-	1.25	-	26.25	0.72	21	-	-	-

Notes: Sold in full bundles only on a refundable skid. Beacon Hill 80mm is approved for vehicular applications. All measurements are nominal.  
**Important: A urethane rubber paver mat must be used to prevent scuffing.** For more information, samples or custom options, please contact your Unilock Territory Manager or call 1-800-UNILOCK.

**APPLICATIONS**



RECOMMENDED SANDS				RECOMMENDED SEALER																			
 <p><b>Romex: Rompox® ECO-Fine</b> Pedestrian Applications only</p> <ul style="list-style-type: none"> <li>  Ready mixed and easy to use</li> <li>  Resin film free</li> <li>  Resistant to ants, weeds, de-icing salts</li> <li>  Made from 98% natural, recycled or renewable raw materials</li> <li>  Pressure washer safe</li> <li>  Ideal for joint widths from 5mm (1/4")</li> </ul> <p>Coverage:</p> <table border="1"> <thead> <tr> <th>Colour</th> <th>5-6mm Joints</th> </tr> </thead> <tbody> <tr> <td>Beige, Stone Grey, Anthracite 55 lb bag / 1 kg can</td> <td>125 sqft / 55 lb mix</td> </tr> </tbody> </table>		Colour	5-6mm Joints	Beige, Stone Grey, Anthracite 55 lb bag / 1 kg can	125 sqft / 55 lb mix	 <p><b>Romex: Rompox® D1</b> Vehicular Applications</p> <ul style="list-style-type: none"> <li>  Light to medium vehicle rated</li> <li>  Resistant to ants, weeds, frost &amp; de-icing salts</li> <li>  Self-compacting and water emulsifiable</li> <li>  Ideal for joint widths from 3mm (1/4")</li> <li>  Ideal for driveways, parking spaces and all vehicular loading applications up to 7.5 T</li> </ul> <p>Coverage:</p> <table border="1"> <thead> <tr> <th>Colour</th> <th>7mm Joints</th> </tr> </thead> <tbody> <tr> <td>Neutral, Stone Grey, Basalt Two 1 L bottles to be mixed with one 55 lb bag of Romex approved sand</td> <td>20 sqft / 55 lb mix (based on 1,000 sqft)</td> </tr> </tbody> </table>		Colour	7mm Joints	Neutral, Stone Grey, Basalt Two 1 L bottles to be mixed with one 55 lb bag of Romex approved sand	20 sqft / 55 lb mix (based on 1,000 sqft)	 <p><b>Alliance - Gator G2 MAXX Sand</b></p> <ul style="list-style-type: none"> <li>  Rain safe after 15 minutes (24hr no rain if concrete overlay)</li> <li>  Sets above 32° F/ 0° C - may vary depending on weather, drainage, bedding materials and installation</li> <li>  Dust free and haze free</li> <li>  Requires only one watering</li> <li>  Four colours: Beige, Grey, Black and Ivory</li> </ul> <p>Coverage:</p> <table border="1"> <thead> <tr> <th>Colour</th> <th>Narrow Joints</th> <th>Wide Joints</th> </tr> </thead> <tbody> <tr> <td>Beige, Grey, Ivory 50 lb bag</td> <td>65-85 sqft</td> <td>22-42 sqft</td> </tr> <tr> <td>Black 50lb. bag</td> <td>58-76 sqft</td> <td>20-38 sqft</td> </tr> </tbody> </table>			Colour	Narrow Joints	Wide Joints	Beige, Grey, Ivory 50 lb bag	65-85 sqft	22-42 sqft	Black 50lb. bag	58-76 sqft	20-38 sqft
Colour	5-6mm Joints																						
Beige, Stone Grey, Anthracite 55 lb bag / 1 kg can	125 sqft / 55 lb mix																						
Colour	7mm Joints																						
Neutral, Stone Grey, Basalt Two 1 L bottles to be mixed with one 55 lb bag of Romex approved sand	20 sqft / 55 lb mix (based on 1,000 sqft)																						
Colour	Narrow Joints	Wide Joints																					
Beige, Grey, Ivory 50 lb bag	65-85 sqft	22-42 sqft																					
Black 50lb. bag	58-76 sqft	20-38 sqft																					
 <p><b>Alliance - Gator Natural Look Sealer</b></p> <ul style="list-style-type: none"> <li>  Water-based</li> <li>  Zero gloss finish</li> <li>  Multi purpose</li> <li>  Rain safe after 24 hours</li> </ul> <p>Coverage:</p> <table border="1"> <thead> <tr> <th>Size</th> <th>Area</th> </tr> </thead> <tbody> <tr> <td>3.78 L / 1 U.S. gal.</td> <td>175 sqft</td> </tr> <tr> <td>18.9 L / 5.28 U.S. gal.</td> <td>875 sqft</td> </tr> </tbody> </table>						Size	Area	3.78 L / 1 U.S. gal.	175 sqft	18.9 L / 5.28 U.S. gal.	875 sqft												
Size	Area																						
3.78 L / 1 U.S. gal.	175 sqft																						
18.9 L / 5.28 U.S. gal.	875 sqft																						

\*Please refer to Sands & Sealers on pages 190-202 for more detailed information.

Unsure of bonded vs. unbonded product recommendations? Please contact your Unilock Territory Manager for more information.

# BEACON HILL™ SMOOTH 60mm

ENDURACOLOR™



ALMOND GROVE FUSION  
NOT AVAILABLE IN SLAB



FOSSIL



GRANITE MIST

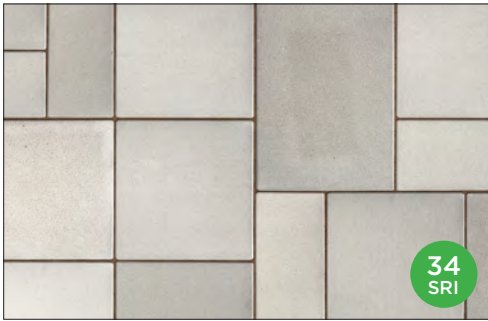

OPAL BLEND

34  
SRI



TUSCANY

44  
SRI



DARK BROWN **NEW**  
Small rectangle bundle only



MIDNIGHT CHARCOAL  
Small rectangle bundle only



OPAL BLEND  
Small rectangle bundle only

34  
SRI

## VISUAL APPEARANCE

Flat surface texture for a sleek, modern look with a contemporary colour palette.

## FINISH

Smooth with Enduracolor™ finish.

## PRODUCT SPECIFICATIONS



**LARGE RECTANGLE**  
15 x 22½ x 2⅜"  
380 x 570 x 60mm



**SQUARE**  
15 x 15 x 2⅜"  
380 x 380 x 60mm



**SMALL RECTANGLE**  
7½ x 15 x 2⅜"  
190 x 380 x 60mm

3 UNIT RANDOM BUNDLE

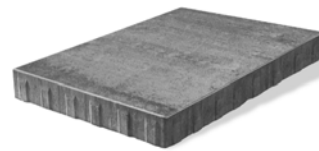

**SLAB**  
22½ x 37½ x 2⅜"  
570 x 950 x 60mm  
See Slabs section page 94 for  
more details.



**SMALL RECTANGLE  
BUNDLE**  
7½ x 15 x 2⅜"  
190 x 380 x 60mm  
Only available in Dark Brown,  
Midnight Charcoal and  
Opal Blend.

\*Colour selection should be chosen from actual samples.

EDGE DETAILS



ROUNDED EDGE

BUNDLE CONFIGURATION

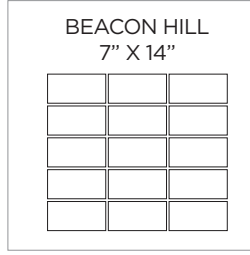

LAYING PATTERNS

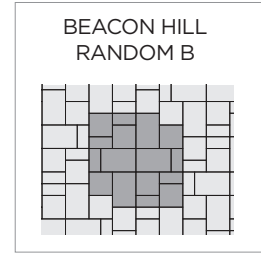
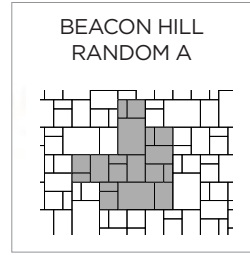

BHF RANDOM A

40% Large Rectangle, 40% Square, 20% Small Rectangle

BHF RANDOM B

40% Large Rectangle, 40% Square, 20% Small Rectangle

TECHNICAL INFORMATION

ASTM C 936 Standard Specifications for Solid Concrete Interlocking Paving Units

Conforms to:

- C140 for Absorption 4% avg - 5% max
- C140 for Compressive Strength > 8,000 PSI avg.
- C1645 for Freeze-thaw Durability
- C418 for Abrasion Durability
- Dimensional Accuracy +/- 3mm

Test results available upon request

Meets the U.S. Architectural & Transportation Barrier Compliance Board Slip-Resistance Surfaces Advisory Guidelines

SOLAR REFLECTIVE INDEX (SRI) TESTING DETAILS

Product	Solar Reflectance	SRI
Opal Blend	0.32	34
Tuscany	0.39	44

TECHNICAL ADVANTAGES

ENDURACOLOR™

Refined surface and long-lasting colour

PEDESTRIAN FRIENDLY

Not recommended for vehicular

LEED INFORMATION

Materials & Resources: LEED V4:

- Building Product Disclosure and Optimization
- Sourcing of Raw Materials - Sourcing of Raw Materials and Extraction • 1 point
- Sourcing of Raw Materials - Leadership Extraction Practices • 1 point
- Material Ingredient Reporting - Material Ingredient Reporting • 1 point
- Material Ingredient Reporting - Material Ingredient Optimization • 1 point
- Environmental Product Declaration • 1 point

PRODUCT DATA

Stones & Bundling	Unit Thickness	SqFt Per				Per Bundle		Soldier LnFt Per			Sailor LnFt per			Units Per		Lbs Per		
		Bundle	Layer	Section	Stone	Layers	Section	Unit	Layer	Bundle	Unit	Layer	Bundle	SqFt	Bundle	Layer	Section	Bundle
Fossil, Granite Mist and Midnight Charcoal manufactured in Ayr / All other colours manufactured in Pickering																		
Random Bundle		104.91	11.65	-	-	9	-	-	-	-	-	9.35	84.15	0.69	72	319.93	-	2,879.4
Large Rectangle	2 3/8" (60mm)	-	4.66	-	2.33	-	-	-	-	-	1.87	3.74	33.66	0.48	18	-	-	-
Small Rectangle	2 3/8" (60mm)	-	2.33	-	0.78	-	-	-	-	-	0.63	1.87	16.83	0.69	27	-	-	-
Square	2 3/8" (60mm)	-	4.66	-	1.55	-	-	-	-	-	1.25	3.74	33.66	0.72	27	-	-	-
Small Rectangle (Smooth only)	2 3/8" (60mm)	104.92	11.66	-	0.78	9	-	0.63	-	84.38	1.25	1.87	168.75	0.69	135	319.93	-	2,879.4
Slab	2 3/8" (60mm)	69.94	11.66	-	5.83	6	-	1.88	-	22.44	3.11	6.23	37.38	0.17	12	319.80	-	1,918.80

Notes: Sold in full bundles only on a refundable skid. Beacon Hill 60mm is not intended for vehicular applications. All measurements are nominal. Important: A urethane rubber paver mat must be used to prevent scuffing. For more information, samples or custom options, please contact your Unilock Territory Manager or call 1-800-UNILOCK.

APPLICATIONS



Pedestrian



Roof Deck



\*Wall pairing suggestion- U-CARA\* - matching colour and finish

RECOMMENDED SANDS



**Romex: Rompox™ ECO-Fine**  
Pedestrian Applications only  
Vehicular when laid on a Trass Bed

- | Ready mixed and easy to use
- | Resin film free
- | Resistant to ants, weeds, de-icing salts
- | Made from 98% natural, recycled or renewable raw materials
- | Pressure washer safe
- | Ideal for joint widths from 5mm (1/4")

Coverage:

Colour	5-6mm Joints
Beige, Stone Grey, Anthracite 55 lb bag / 1 kg can	125 sqft / 55 lb mix



**Alliance - Gator G2 MAXX Sand**

- | Rain safe after 15 minutes (24hr no rain if concrete overlay)
- | Sets above 32° F/ 0° C - may vary depending on weather, drainage, bedding materials and installation
- | Dust free and haze free
- | Requires only one watering

Coverage:

Colour	Narrow Joints	Wide Joints
Beige, Grey, Ivory 50 lb bag	65-85 sqft	22-42 sqft
Black 50 lb bag	58-76 sqft	20-38 sqft

RECOMMENDED SEALER



**Alliance - Gator Natural Look Sealer**

- | Water-based
- | Zero gloss finish
- | Multi purpose
- | Rain safe after 24 hours

Coverage:

Size	Area
3.78 L / 1 U.S. gal.	175 sqft
18.9 L / 5.28 U.S. gal.	875 sqft

\*Please refer to Sands & Sealers on pages 190-202 for more detailed information.

Unsure of bonded vs. unbonded product recommendations? Please contact your Unilock Territory Manager for more information.



# BEACON HILL™ SMOOTH 80mm

ENDURACOLOR™



ALMOND GROVE FUSION



FOSSIL



GRANITE MIST



OPAL BLEND

34  
SRI



TUSCANY

44  
SRI



DARK BROWN **NEW**  
*Small rectangle bundle only*



MIDNIGHT CHARCOAL  
*Small rectangle bundle only*



OPAL BLEND  
*Small rectangle bundle only*

34  
SRI

## VISUAL APPEARANCE

Smooth surface texture for a sleek, modern look with a contemporary colour palette.

## FINISH

Smooth with Enduracolor™ finish.

## PRODUCT SPECIFICATIONS



**LARGE RECTANGLE**  
15 x 22½ x 3⅝"  
380 x 570 x 80mm



**SQUARE**  
15 x 15 x 3⅝"  
380 x 380 x 80mm



**SMALL RECTANGLE**  
7½ x 15 x 3⅝"  
190 x 380 x 80mm



**SMALL RECTANGLE BUNDLE**  
7½ x 15 x 3⅝"  
190 x 380 x 80mm

3 UNIT RANDOM BUNDLE

*Only available in Dark Brown, Midnight Charcoal and Opal Blend.*

\*Colour selection should be chosen from actual samples.

EDGE DETAILS

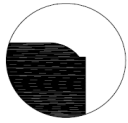

ROUNDED EDGE

BUNDLE CONFIGURATION

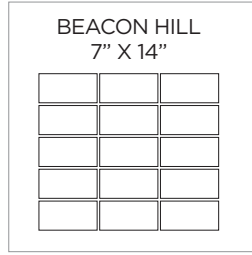

LAYING PATTERNS

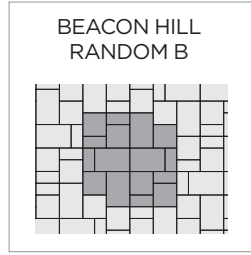
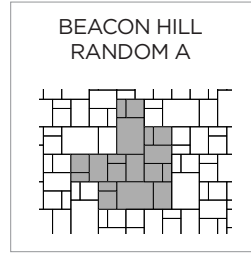

BHF RANDOM A

40% Large Rectangle, 40% Square, 20% Small Rectangle

BHF RANDOM B

40% Large Rectangle, 40% Square, 20% Small Rectangle

TECHNICAL INFORMATION

ASTM C 936 Standard Specifications for Solid Concrete Interlocking Paving Units

Conforms to:

- C140 for Absorption 4% avg - 5% max
- C140 for Compressive Strength > 8,000 PSI avg.
- C1645 for Freeze-thaw Durability
- C418 for Abrasion Durability
- Dimensional Accuracy +/- 3mm

Test results available upon request

Meets the U.S. Architectural & Transportation Barrier Compliance Board Slip-Resistance Surfaces Advisory Guidelines

SOLAR REFLECTIVE INDEX (SRI) TESTING DETAILS

Product	Solar Reflectance	SRI
Opal Blend	0.32	34 <span style="color: green;">34 SRI</span>
Tuscany	0.39	44 <span style="color: green;">44 SRI</span>

TECHNICAL ADVANTAGES

ENDURACOLOR™

Refined surface and long-lasting colour

DRIVE FRIENDLY

80mm pavers can handle vehicular loads  
Ask about our base stabilization system

LEED INFORMATION

Materials & Resources: LEED V4:

- Building Product Disclosure and Optimization
- Sourcing of Raw Materials - Sourcing of Raw Materials and Extraction • 1 point
- Sourcing of Raw Materials - Leadership Extraction Practices • 1 point
- Material Ingredient Reporting - Material Ingredient Reporting • 1 point
- Material Ingredient Reporting - Material Ingredient Optimization • 1 point
- Environmental Product Declaration • 1 point

PRODUCT DATA

Stones & Bundling	Unit Thickness	SqFt Per				Per Bundle		Soldier LnFt Per			Sailor LnFt per			Units Per			Lbs Per		
		Bundle	Layer	Section	Stone	Layers	Section	Unit	Section	Bundle	Unit	Layer	Bundle	SqFt	Bundle	Layer	Layer	Section	Bundle
Fossil, Granite Mist and Midnight Charcoal manufactured in Ayr / All other colours manufactured in Pickering																			
Random Bundle		81.60	11.65	-	-	7	-	-	-	-	-	8.86	65.66	0.69	56	-	383	-	2,986
Large Rectangle	3 3/8" (80mm)	-	4.66	-	2.33	-	-	-	-	-	1.87	-	26.25	0.48	14	-	-	-	-
Small Rectangle	3 3/8" (80mm)	-	2.33	-	0.77	-	-	-	-	-	1.25	-	13.23	0.69	21	-	-	-	-
Square	3 3/8" (80mm)	-	4.66	-	1.55	-	-	-	-	-	1.25	-	26.25	0.72	21	-	-	-	-
Small Rectangle (Smooth only)	3 3/8" (80mm)	81.60	11.55	-	0.77	7	-	0.63	-	-	1.25	-	131.25	0.69	105	15	426	-	2,985

Notes: Sold in full bundles only on a refundable skid. Beacon Hill 80mm is approved for vehicular applications. All measurements are nominal. Important: A urethane rubber paver mat must be used to prevent scuffing. For more information, samples or custom options, please contact your Unilock Territory Manager or call 1-800-UNILOCK.

APPLICATIONS

Pedestrian    
 Residential Vehicular    
 Commercial Vehicular    
 \*Wall pairing suggestion- U-CARA\* - matching colour and finish

RECOMMENDED SANDS

RECOMMENDED SEALER



Romex: Rompox® ECO-Fine  
Pedestrian Applications only

- Ready mixed and easy to use
- Resin film free
- Resistant to ants, weeds, de-icing salts
- Made from 98% natural, recycled or renewable raw materials
- Pressure washer safe
- Ideal for joint widths from 5mm (1/4")

Coverage:

Colour	5-6mm Joints
Beige, Stone Grey, Anthracite 55 lb bag / 1 kg can	125 sqft / 55 lb mix



Romex: Rompox® D1  
Vehicular Applications

- Light to medium vehicle rated
- Resistant to ants, weeds, frost & de-icing salts
- Self-compacting and water emulsifiable
- Ideal for joint widths from 3mm (1/4")
- Ideal for driveways, parking spaces and all vehicular loading applications up to 7.5 T

Coverage:

Colour	7mm Joints
Neutral, Stone Grey, Basalt Two 1 L bottles to be mixed with one 55 lb bag of Romex approved sand	20 sqft / 55 lb mix (based on 1,000 sqft)



Alliance - Gator G2 MAXX Sand

- Rain safe after 15 minutes (24hr no rain if concrete overlay)
- Sets above 32° F/ 0° C - may vary depending on weather, drainage, bedding materials and installation
- Dust free and haze free
- Requires only one watering
- Four colours: Beige, Grey, Black and Ivory

Coverage:

Colour	Narrow Joints	Wide Joints
Beige, Grey, Ivory 50 lb bag	65-85 sqft	22-42 sqft
Black 50lb. bag	58-76 sqft	20-38 sqft



Alliance - Gator Natural Look Sealer

- Water-based
- Zero gloss finish
- Multi purpose
- Rain safe after 24 hours

Coverage:

Size	Area
3.78 L / 1 U.S. gal.	175 sqft
18.9 L / 5.28 U.S. gal.	875 sqft

\*Please refer to Sands & Sealers on pages 190-202 for more detailed information.

Unsure of bonded vs. unbonded product recommendations? Please contact your Unilock Territory Manager for more information.

# BRISTOL VALLEY<sup>®</sup> 60mm

ENDURACOLOR<sup>™</sup>



GRANITE FUSION



OAK BROWN FUSION **NEW**

## VISUAL APPEARANCE

Gentle surface clefts and waved edges.

## FINISH

The subtle surface texture and understated edge detail of Bristol Valley<sup>®</sup> brings a refined elegance to projects where a more commonplace flagstone slab may have been used in the past.

## PRODUCT SPECIFICATIONS



### LARGE RECTANGLE

15 x 22½ x 2⅜"  
380 x 570 x 60 mm



### SQUARE

15 x 15 x 2⅜"  
380 x 380 x 60mm



### SMALL RECTANGLE

7 ½ x 15 x 2⅜"  
190 x 380 x 60mm

3 UNIT RANDOM BUNDLE

## EDGE DETAILS



WAVED EDGE

## BUNDLE CONFIGURATION

BRISTOL VALLEY  
RANDOM BUNDLE

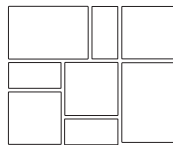

## LAYING PATTERNS

BRISTOL VALLEY  
RANDOM A

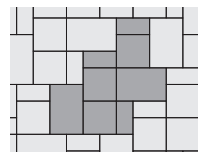

BRISTOL VALLEY RANDOM A

40% Large Rectangle, 40%  
Square, 20% Small Rectangle

BRISTOL VALLEY  
RANDOM B

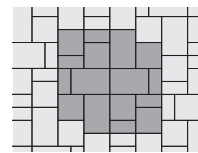

BRISTOL VALLEY RANDOM B

40% Large Rectangle, 40%  
Square, 20% Small Rectangle

\*Colour selection should be chosen from actual samples.



**TECHNICAL INFORMATION**

**ASTM C 936 Standard Specifications for Solid Concrete Interlocking Paving Units**

Conforms to:

- C140 for Absorption 5% avg - 7% max
- C140 for Compressive Strength > 7,200 PSI avg.
- C67 for Freeze-thaw Durability
- C418 for Abrasion Durability
- Dimensional Accuracy **+/- 3 mm**

Test results available upon request

Meets the U.S. Architectural & Transportation Barrier Compliance Board Slip-Resistance Surfaces Advisory Guidelines

**LEED INFORMATION**

**Materials & Resources: LEED V4:**

- Building Product Disclosure and Optimization
- Sourcing of Raw Materials - Sourcing of Raw Materials and Extraction • **1 point**
- Sourcing of Raw Materials - Leadership Extraction Practices • **1 point**
- Material Ingredient Reporting - Material Ingredient Reporting • **1 point**
- Material Ingredient Reporting - Material Ingredient Optimization • **1 point**
- Environmental Product Declaration • **1 point**

**TECHNICAL ADVANTAGES**

**ENDURACOLOR™**

Refined surface and long-lasting colour

**PEDESTRIAN FRIENDLY**

Not recommended for vehicular

**PRODUCT DATA**

Stones & Bundling	Unit Thickness	SqFt Per				Per Bundle		Soldier LnFt per			Sailor LnFt per			Units Per			Lbs Per		
		Bundle	Layer	Section	Stone	Layers	Sections	Unit	Layer	Bundle	Unit	Layer	Bundle	SqFt	Layer	Bundle	Unit	Layer	Bundle
<b>Pickering Manufacturing</b>																			
Random Bundle		104.91	11.66	-	1.46	9	-	-	-	-	0.90	9.35	84.15	0.69	8	72	35.68	319.8	2,878.20
Large Rectangle	2 3/8" (60 mm)	-	-	-	2.09	-	-	-	-	-	1.88	-	-	0.48	-	18	-	-	-
Square	2 3/8" (60 mm)	-	-	-	1.40	-	-	-	-	-	1.25	-	-	1.43	-	27	-	-	-
Small Rectangle	2 3/8" (60 mm)	-	-	-	0.70	-	-	-	-	-	0.63	-	-	0.72	-	27	-	-	-

Notes: Product sold in full bundles only on a refundable skid. All measurements are nominal. **Product is not intended for vehicular applications. Important: A urethane rubber paver mat must be used to prevent scuffing.** For more information, samples or custom options, please contact your Unilock Territory Manager or call 1-800-UNILOCK.

**APPLICATIONS**





Pedestrian



Roof Deck



\*Wall pairing suggestion- U-CARA\* - matching colour and finish

RECOMMENDED SANDS			RECOMMENDED SEALER																								
 <p><b>Romex: Rompox® ECO-Fine</b> Pedestrian Applications only Vehicular when laid on a Trass Bed</p> <ul style="list-style-type: none"> <li>  Ready mixed and easy to use</li> <li>  Resin film free</li> <li>  Resistant to ants, weeds, de-icing salts</li> <li>  Made from 98% natural, recycled or renewable raw materials</li> <li>  Pressure washer safe</li> <li>  Ideal for joint widths from 5mm (1/4")</li> </ul> <p><b>Coverage:</b></p> <table border="1"> <thead> <tr> <th>Colour</th> <th>5-6mm Joints</th> </tr> </thead> <tbody> <tr> <td>Beige, Stone Grey, Anthracite 55 lb bag / 1 kg can</td> <td>125 sqft / 55 lb mix</td> </tr> </tbody> </table>			Colour	5-6mm Joints	Beige, Stone Grey, Anthracite 55 lb bag / 1 kg can	125 sqft / 55 lb mix	 <p><b>Alliance - Gator G2 MAXX Sand</b></p> <ul style="list-style-type: none"> <li>  Rain safe after 15 minutes (24hr no rain if concrete overlay)</li> <li>  Sets above 32° F/ 0° C - may vary depending on weather, drainage, bedding materials and installation</li> <li>  Dust free and haze free</li> <li>  Requires only one watering</li> <li>  Four colours: Beige, Grey, Black and Ivory</li> </ul> <p><b>Coverage:</b></p> <table border="1"> <thead> <tr> <th>Colour</th> <th>Narrow Joints</th> <th>Wide Joints</th> </tr> </thead> <tbody> <tr> <td>Beige, Grey, Ivory 50 lb bag</td> <td>65-85 sqft</td> <td>22-42 sqft</td> </tr> <tr> <td>Black 50 lb bag</td> <td>58-76 sqft</td> <td>20-38 sqft</td> </tr> </tbody> </table>			Colour	Narrow Joints	Wide Joints	Beige, Grey, Ivory 50 lb bag	65-85 sqft	22-42 sqft	Black 50 lb bag	58-76 sqft	20-38 sqft	 <p><b>Alliance - Gator Natural Look Sealer</b></p> <ul style="list-style-type: none"> <li>  Water-based</li> <li>  Zero gloss finish</li> <li>  Multi purpose</li> <li>  Rain safe after 24 hours</li> </ul> <p><b>Coverage:</b></p> <table border="1"> <thead> <tr> <th>Size</th> <th>Area</th> </tr> </thead> <tbody> <tr> <td>3.78 L / 1 U.S. gal.</td> <td>175 sqft</td> </tr> <tr> <td>18.9 L / 5.28 U.S. gal.</td> <td>875 sqft</td> </tr> </tbody> </table>			Size	Area	3.78 L / 1 U.S. gal.	175 sqft	18.9 L / 5.28 U.S. gal.	875 sqft
Colour	5-6mm Joints																										
Beige, Stone Grey, Anthracite 55 lb bag / 1 kg can	125 sqft / 55 lb mix																										
Colour	Narrow Joints	Wide Joints																									
Beige, Grey, Ivory 50 lb bag	65-85 sqft	22-42 sqft																									
Black 50 lb bag	58-76 sqft	20-38 sqft																									
Size	Area																										
3.78 L / 1 U.S. gal.	175 sqft																										
18.9 L / 5.28 U.S. gal.	875 sqft																										

\*Please refer to Sands & Sealers on pages 190-202 for more detailed information.

Unsure of bonded vs. unbonded product recommendations? Please contact your Unilock Territory Manager for more information.

# BRISTOL VALLEY<sup>®</sup> 80mm

## ENDURACOLOR™



GRANITE FUSION

OAK BROWN FUSION **NEW**

### VISUAL APPEARANCE

Gentle surface clefts and waved edges.

### FINISH

The subtle surface texture and understated edge detail of Bristol Valley<sup>®</sup> brings a refined elegance to projects where a more commonplace flagstone slab may have been used in the past.

### PRODUCT SPECIFICATIONS



#### LARGE RECTANGLE

15 x 22½ x 3⅞"  
380 x 570 x 80 mm



#### SQUARE

15 x 15 x 3⅞"  
380 x 380 x 80 mm



#### SMALL RECTANGLE

7½ x 15 x 3⅞"  
190 x 380 x 80 mm

3 UNIT RANDOM BUNDLE

### EDGE DETAILS



WAVED EDGE

### BUNDLE CONFIGURATION

BRISTOL VALLEY  
RANDOM BUNDLE

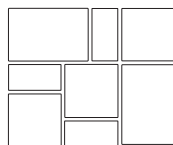

### LAYING PATTERNS

BRISTOL VALLEY  
RANDOM A

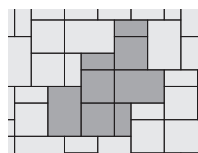

BRISTOL VALLEY RANDOM A

40% Large Rectangle, 40%  
Square, 20% Small Rectangle

BRISTOL VALLEY  
RANDOM B

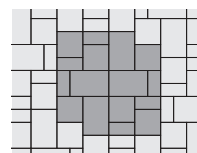

BRISTOL VALLEY RANDOM B

40% Large Rectangle, 40%  
Square, 20% Small Rectangle

\*Colour selection should be chosen from actual samples.

**TECHNICAL INFORMATION**

**ASTM C 936 Standard Specifications for Solid Concrete Interlocking Paving Units**

Conforms to:

- C140 for Absorption 5% avg - 7% max
- C140 for Compressive Strength > 7,200 PSI avg.
- C67 for Freeze-thaw Durability
- C418 for Abrasion Durability
- Dimensional Accuracy **+/- 3 mm**

Test results available upon request

**Meets the U.S. Architectural & Transportation Barrier Compliance Board Slip-Resistance Surfaces Advisory Guidelines**

**LEED INFORMATION**

**Materials & Resources: LEED V4:**

- Building Product Disclosure and Optimization
- Sourcing of Raw Materials - Sourcing of Raw Materials and Extraction • **1 point**
- Sourcing of Raw Materials - Leadership Extraction Practices • **1 point**
- Material Ingredient Reporting - Material Ingredient Reporting • **1 point**
- Material Ingredient Reporting - Material Ingredient Optimization • **1 point**
- Environmental Product Declaration • **1 point**

**TECHNICAL ADVANTAGES**

**ENDURACOLOR™**

Refined surface and long-lasting colour

**DRIVE FRIENDLY**

80mm pavers can handle vehicular loads

Ask about our base stabilization system

**PRODUCT DATA**

Stones & Bundling	Unit		SqFt Per				Per Bundle		Soldier LnFt per			Sailor LnFt per			Units Per		Lbs Per		
	Thickness	Bundle	Layer	Section	Stone	Layers	Sections	Unit	Layer	Bundle	Unit	Layer	Bundle	SqFt	Layer	Bundle	Unit	Layer	Bundle
<b>Pickering Manufacturing</b>																			
Random Bundle		81.6	11.66	-	1.46	7	-	-	-	-	0.90	9.35	65.45	0.69	7	49	35.68	426.57	2,986.02
Large Rectangle	3 3/8" (80mm)	-	-	-	2.09	-	-	-	-	-	1.88	-	-	0.48	-	14	-	-	-
Square	3 3/8" (80mm)	-	-	-	1.40	-	-	-	-	-	1.25	-	-	1.43	-	21	-	-	-
Small Rectangle	3 3/8" (80mm)	-	-	-	0.70	-	-	-	-	-	0.63	-	-	0.72	-	21	-	-	-

Notes: Product sold in full bundles only on a refundable skid. All measurements are nominal. **Product is not intended for vehicular applications. Important: A urethane rubber paver mat must be used to prevent scuffing.** For more information, samples or custom options, please contact your Unilock Territory Manager or call 1-800-UNILOCK.

**APPLICATIONS**



Pedestrian



Residential Vehicular



Commercial Vehicular



\*Wall pairing suggestion- U-CARA® - matching colour and finish

**RECOMMENDED SANDS**

**RECOMMENDED SEALER**



**Romex: Rompox® ECO-Fine**  
Pedestrian Applications only

- | Ready mixed and easy to use
- | Resin film free
- | Resistant to ants, weeds, de-icing salts
- | Made from 98% natural, recycled or renewable raw materials
- | Pressure washer safe
- | Ideal for joint widths from 5mm (1/4")

Coverage:

Colour	5-6mm Joints
Beige, Stone Grey, Anthracite 55 lb bag / 1 kg can	125 sqft / 55 lb mix



**Romex: Rompox® D1**  
Vehicular Applications

- | Light to medium vehicle rated
- | Resistant to ants, weeds, frost & de-icing salts
- | Self-compacting and water emulsifiable
- | Ideal for joint widths from 3mm (1/4")
- | Ideal for driveways, parking spaces and all vehicular loading applications up to 7.5 T

Coverage:

Colour	7mm Joints
Neutral, Stone Grey, Basalt Two 1 L bottles to be mixed with one 55 lb bag of Romex approved sand	20 sqft / 55 lb mix (based on 1,000 sqft)



**Alliance - Gator G2 MAXX Sand**

- | Rain safe after 15 minutes (24hr no rain if concrete overlay)
- | Sets above 32° F/ 0° C - may vary depending on weather, drainage, bedding materials and installation
- | Dust free and haze free
- | Requires only one watering
- | Four colours: Beige, Grey, Black and Ivory

Coverage:

Colour	Narrow Joints	Wide Joints
Beige, Grey, Ivory 50 lb bag	65-85 sqft	22-42 sqft
Black 50lb. bag	58-76 sqft	20-38 sqft



**Alliance - Gator Natural Look Sealer**

- | Water-based
- | Zero gloss finish
- | Multi purpose
- | Rain safe after 24 hours

Coverage:

Size	Area
3.78 L / 1 U.S. gal.	175 sqft
18.9 L / 5.28 U.S. gal.	875 sqft

\*Please refer to Sands & Sealers on pages 190-202 for more detailed information.

Unsure of bonded vs. unbonded product recommendations? Please contact your Unilock Territory Manager for more information.

# BRONTE<sup>®</sup> STREET PAVER

## CLASSIC

*\*Special Order only. Minimum qtys apply\**



NATURAL



### VISUAL APPEARANCE

Natural, aged look.

### FINISH

Distressed finish.

### PRODUCT SPECIFICATIONS



5½ x 8⅝ x 4"  
140 x 220 x 100mm

### EDGE DETAILS



TUMBLLED EDGE

\*Colour selection should be chosen from actual samples.

**TECHNICAL INFORMATION**

**ASTM C936 Standard Specifications for Solid Concrete Interlocking Paving Units**

Conforms to:

- C140 for Absorption 5% avg - 7% max
- C140 for Compressive Strength > 7,200 PSI avg.
- C67 for Freeze-thaw Durability
- C418 for Abrasion Durability
- Dimensional Accuracy **+/- 3mm**

*Test results available upon request*

**Meets the U.S. Architectural & Transportation Barrier Compliance Board Slip-Resistance Surfaces Advisory Guidelines**

**SOLAR REFLECTIVE INDEX (SRI) TESTING DETAILS**

Product	Solar Reflectance	SRI
Natural	0.30	32 

**LEED INFORMATION**

**Materials & Resources: LEED V4:**

- Building Product Disclosure and Optimization
- Sourcing of Raw Materials - Sourcing of Raw Materials and Extraction • **1 point**
- Sourcing of Raw Materials - Leadership Extraction Practices • **1 point**
- Material Ingredient Reporting - Material Ingredient Reporting • **1 point**
- Material Ingredient Reporting - Material Ingredient Optimization • **1 point**
- Environmental Product Declaration • **1 point**

**TECHNICAL ADVANTAGES**

**CLASSIC**

Budget-friendly. Utilizes a traditional product mix of large and small aggregates that's consistent from top to bottom with colour mixed throughout.

**ANTIQUED FINISH**

Distressed, timeworn finish

**DRIVE FRIENDLY**

Can handle vehicular loads  
*Ask about our base stabilization system*

**PRODUCT DATA**

Stones & Bundling	Unit	SqFt Per			Per Bundle		Soldier LnFt Per			Sailor LnFt per			Units Per			Lbs Per			
	Thickness	Bundle	Layer	Section	Stone	Layers	Sections	Unit	Section	Bundle	Unit	Section	Bundle	SqFt	Section	Bundle	Layer	Section	Bundle
<b>Ayr Manufacturing</b>																			
Standard	4" (100mm)	55.68	9.28	-	0.332	6	-	0.46	-	77.28	0.72	-	120.96	-	-	168	397.18	-	2,383.08

Notes: Product sold in full bundles only on a refundable skid. All measurements are nominal. **Important: A urethane rubber paver mat must be used to prevent scuffing.** For more information, samples or custom options, please contact your Unilock Territory Manager or call 1-800-UNILOCK.

**APPLICATIONS**





Pedestrian



Commercial Vehicular



\*Wall pairing suggestion- Brussels Dimensional Stone\* - matching colour and finish

RECOMMENDED SANDS				RECOMMENDED SEALER																							
																											
<p><b>Romex: Rompox® Fugensand</b> Pedestrian, Vehicular and Heavy Duty Vehicular Applications</p> <ul style="list-style-type: none"> <li>Manufactured from natural, raw materials</li> <li>Allows for efficient stormwater management and more durable paver joint</li> <li>Quick application</li> <li>Self-repairing properties</li> <li>Suitable for all load classes</li> <li>No cement haze/residue due to natural polymer binders</li> </ul>		<p><b>Romex: Rompox® D7000 Joint Strengthener &amp; Surface Sealer</b> Pedestrian, Vehicular and Heavy Duty Vehicular Applications</p> <ul style="list-style-type: none"> <li>All-in-one strengthener &amp; sealer</li> <li>Eco-Friendly</li> <li>Protects against dirt, oil, corrosion from climate exposure, de-icing salts</li> <li>Protects against weed growth and wash outs</li> <li>Allows for light surface pressure washing once cured</li> </ul>		<p><b>Alliance - Gator G2 Super Sand</b></p> <ul style="list-style-type: none"> <li>Rain safe after 1 hour (no concrete overlays)</li> <li>Sets above 32° F/ 0° C - may vary depending on weather, drainage, bedding materials and installation</li> <li>Can be used for joints up to a max of 2"</li> <li>Dust free and haze free</li> <li>Requires only one watering</li> <li>Two colours: Beige, Slate Grey</li> </ul>		<p><b>Alliance - Gator Natural Look Sealer</b></p> <ul style="list-style-type: none"> <li>Water-based</li> <li>Zero gloss finish</li> <li>Multi purpose</li> <li>Rain safe after 24 hours</li> </ul>																					
<p>Coverage:</p> <table border="1"> <thead> <tr> <th>Colour</th> <th>3mm Joints</th> </tr> </thead> <tbody> <tr> <td>Neutral, Stone Grey, Basalt <i>1 L / 5 gal</i></td> <td>50-150 sqft / 55 lb bag</td> </tr> </tbody> </table>		Colour	3mm Joints	Neutral, Stone Grey, Basalt <i>1 L / 5 gal</i>	50-150 sqft / 55 lb bag	<p>Coverage:</p> <table border="1"> <thead> <tr> <th>Colour</th> <th>3-4mm Joints</th> </tr> </thead> <tbody> <tr> <td>Neutral, Stone Grey, Basalt <i>55 lb bag / 1 kg can</i></td> <td>50-150 sqft / 55 lb mix</td> </tr> </tbody> </table>		Colour	3-4mm Joints	Neutral, Stone Grey, Basalt <i>55 lb bag / 1 kg can</i>	50-150 sqft / 55 lb mix	<p>Coverage:</p> <table border="1"> <thead> <tr> <th>Colour</th> <th>Narrow Joints</th> <th>Wide Joints</th> </tr> </thead> <tbody> <tr> <td>Beige, Slate Grey <i>50 lb bag</i></td> <td>65-85 sqft</td> <td>22-42 sqft</td> </tr> </tbody> </table>		Colour	Narrow Joints	Wide Joints	Beige, Slate Grey <i>50 lb bag</i>	65-85 sqft	22-42 sqft	<p>Coverage:</p> <table border="1"> <thead> <tr> <th>Size</th> <th>Area</th> </tr> </thead> <tbody> <tr> <td>3.78 L / 1 U.S. gal.</td> <td>175 sqft</td> </tr> <tr> <td>18.9 L / 5.28 U.S. gal.</td> <td>875 sqft</td> </tr> </tbody> </table>		Size	Area	3.78 L / 1 U.S. gal.	175 sqft	18.9 L / 5.28 U.S. gal.	875 sqft
Colour	3mm Joints																										
Neutral, Stone Grey, Basalt <i>1 L / 5 gal</i>	50-150 sqft / 55 lb bag																										
Colour	3-4mm Joints																										
Neutral, Stone Grey, Basalt <i>55 lb bag / 1 kg can</i>	50-150 sqft / 55 lb mix																										
Colour	Narrow Joints	Wide Joints																									
Beige, Slate Grey <i>50 lb bag</i>	65-85 sqft	22-42 sqft																									
Size	Area																										
3.78 L / 1 U.S. gal.	175 sqft																										
18.9 L / 5.28 U.S. gal.	875 sqft																										

\*Please refer to Sands & Sealers on pages 190-202 for more detailed information.

Unsure of bonded vs. unbonded product recommendations? Please contact your Unilock Territory Manager for more information.

# BRUSSELS BLOCK®

## CLASSIC



COFFEE CREEK



LIMESTONE



MAHOGANY



SANDSTONE

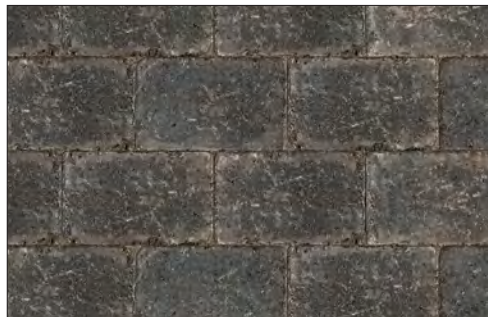

MIDNIGHT CHARCOAL  
*XL, Standard and Fullnose only*

### VISUAL APPEARANCE

The original tumbled paver. Timeless warmth, relaxed appearance.

### FINISH

Tumbled and weathered.

### PRODUCT SPECIFICATIONS



**XL STONE**  
8½ x 13½ x 2¾"  
208 x 348 x 70mm



**STANDARD STONE**  
6¼ x 8½ x 2¾"  
173 x 208 x 70mm



**HALF STONE**  
4½ x 6¼ x 2¾"  
104 x 173 x 70mm



**FULLNOSE COPING**  
5⅞ x 11⅞ x 2¾"  
150 x 300 x 70mm

*Limestone, Sandstone and  
Midnight Charcoal only*

*Please see Steps, Treads and  
Coping section, page 162 for  
more details.*

### EDGE DETAILS

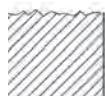

TUMBLLED EDGE

### LAYING PATTERNS

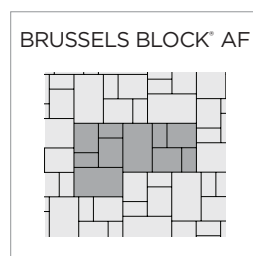

**BRUSSELS AF**  
40% XL, 40% Standard,  
20% Half

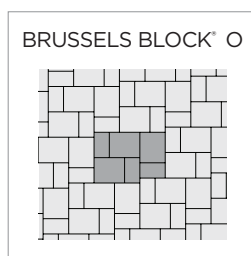

**BRUSSELS O**  
33% Half Stone, 67%  
Standard

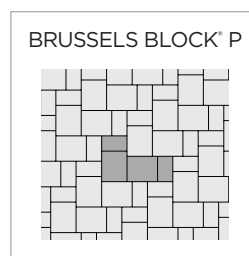

**BRUSSELS P**  
67% Standard, 33% Half

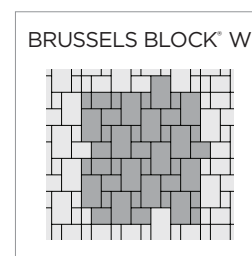

**BRUSSELS W**  
18% Half Stone, 23%  
Standard, 59% XL

\*Colour selection should be chosen from actual samples.

**TECHNICAL INFORMATION**

**ASTM C936 Standard Specifications for Solid Concrete Interlocking Paving Units**



Conforms to:

- C140 for Absorption 5% avg - 7% max
- C140 for Compressive Strength > 7,200 PSI avg.
- C67 for Freeze-thaw Durability
- C418 for Abrasion Durability
- Dimensional Accuracy **+/- 3mm**

*Test results available upon request*

**Meets the U.S. Architectural & Transportation Barrier Compliance Board Slip-Resistance Surfaces Advisory Guidelines**

**SOLAR REFLECTIVE INDEX (SRI) TESTING DETAILS**

Product	Solar Reflectance	SRI
Limestone	0.28	29 
Sandstone	0.41	46 

**LEED INFORMATION**

**Materials & Resources: LEED V4:**

- Building Product Disclosure and Optimization
- Sourcing of Raw Materials - Sourcing of Raw Materials and Extraction • **1 point**
- Sourcing of Raw Materials - Leadership Extraction Practices • **1 point**
- Material Ingredient Reporting - Material Ingredient Reporting • **1 point**
- Material Ingredient Reporting - Material Ingredient Optimization • **1 point**
- Environmental Product Declaration • **1 point**

**TECHNICAL ADVANTAGES**

**CLASSIC**

Budget-friendly. Utilizes a traditional product mix of large and small aggregates that's consistent from top to bottom with colour mixed throughout

**ANTIQUED FINISH**

Distressed, timeworn finish

**DRIVE FRIENDLY**

Can handle vehicular loads  
*Ask about our base stabilization system*

**PRODUCT DATA**

Stones & Bundling	Unit Thickness	SqFt Per				Per Bundle		Soldier LnFt Per			Sailor LnFt per			Units Per			Lbs Per		
		Bundle	Layer	Sections	Stone	Layers	Sections	Unit	Section	Bundle	Unit	Section	Bundle	SqFt	Sections	Bundle	Layer	Section	Bundle
<b>Ayr Manufacturing</b>																			
XL	2 3/4" (70mm)	95.94	11.99	31.98	0.80	8	3	0.70	27.30	81.90	1.43	45.70	137.00	1.25	40	120	378	1,008	3,024
Standard	2 3/4" (70mm)	95.94	11.99	15.99	0.40	8	6	0.58	22.70	136.20	0.70	27.30	163.80	2.50	40	240	383	510	3,064
Half	2 3/4" (70mm)	99.79	12.47	14.26	0.20	8	7	0.34	24.57	172.00	0.58	42.04	294.28	5.05	72	504	399	446	3,124
Fullnose	2 3/4" (70mm)	96.00	12.00	24.00	0.50	8	4	0.51	23.60	96.00	-	-	-	2.00	48	192	355	710	2,841

Notes: All measurements are nominal. For more information, samples or custom options, please contact your Unilock Territory Manager or call 1-800-UNILOCK.

**APPLICATIONS**



Pedestrian





Residential Vehicular



Borders and Accents



\*Wall pairing suggestion- Brussels Dimensional Stone\* - matching colour and finish

RECOMMENDED SANDS				RECOMMENDED SEALER																							
																											
<p><b>Romex: Rompox® Fugensand</b> Pedestrian, Vehicular and Heavy Duty Vehicular Applications</p> <ul style="list-style-type: none"> <li>Manufactured from natural, raw materials</li> <li>Allows for efficient stormwater management and more durable paver joint</li> <li>Quick application</li> <li>Self-repairing properties</li> <li>Suitable for all load classes</li> <li>No cement haze/residue due to natural polymer binders</li> </ul> <p>Coverage:</p> <table border="1"> <thead> <tr> <th>Colour</th> <th>3mm Joints</th> </tr> </thead> <tbody> <tr> <td>Neutral, Stone Grey, Basalt <i>1 L / 5 gal</i></td> <td>50-150 sqft / 55 lb bag</td> </tr> </tbody> </table>		Colour	3mm Joints	Neutral, Stone Grey, Basalt <i>1 L / 5 gal</i>	50-150 sqft / 55 lb bag	<p><b>Romex: Rompox® D7000 Joint Strengthener &amp; Surface Sealer</b> Pedestrian, Vehicular and Heavy Duty Vehicular Applications</p> <ul style="list-style-type: none"> <li>All-in-one strengthener &amp; sealer</li> <li>Eco-Friendly</li> <li>Protects against dirt, oil, corrosion from climate exposure, de-icing salts</li> <li>Protects against weed growth and wash outs</li> <li>Allows for light surface pressure washing once cured</li> </ul> <p>Coverage:</p> <table border="1"> <thead> <tr> <th>Colour</th> <th>3-4mm Joints</th> </tr> </thead> <tbody> <tr> <td>Neutral, Stone Grey, Basalt <i>55 lb bag / 1 kg can</i></td> <td>50-150 sqft / 55 lb mix</td> </tr> </tbody> </table>		Colour	3-4mm Joints	Neutral, Stone Grey, Basalt <i>55 lb bag / 1 kg can</i>	50-150 sqft / 55 lb mix	<p><b>Alliance - Gator G2 Super Sand</b></p> <ul style="list-style-type: none"> <li>Rain safe after 1 hour (no concrete overlays)</li> <li>Sets above 32° F/ 0° C - may vary depending on weather, drainage, bedding materials and installation</li> <li>Can be used for joints up to a max of 2"</li> <li>Dust free and haze free</li> <li>Requires only one watering</li> <li>Two colours: Beige, Slate Grey</li> </ul> <p>Coverage:</p> <table border="1"> <thead> <tr> <th>Colour</th> <th>Narrow Joints</th> <th>Wide Joints</th> </tr> </thead> <tbody> <tr> <td>Beige, Slate Grey <i>50 lb bag</i></td> <td>65-85 sqft</td> <td>22-42 sqft</td> </tr> </tbody> </table>		Colour	Narrow Joints	Wide Joints	Beige, Slate Grey <i>50 lb bag</i>	65-85 sqft	22-42 sqft	<p><b>Alliance - Gator Natural Look Sealer</b></p> <ul style="list-style-type: none"> <li>Water-based</li> <li>Zero gloss finish</li> <li>Multi purpose</li> <li>Rain safe after 24 hours</li> </ul> <p>Coverage:</p> <table border="1"> <thead> <tr> <th>Size</th> <th>Area</th> </tr> </thead> <tbody> <tr> <td>3.78 L / 1 U.S. gal.</td> <td>175 sqft</td> </tr> <tr> <td>18.9 L / 5.28 U.S. gal.</td> <td>875 sqft</td> </tr> </tbody> </table>		Size	Area	3.78 L / 1 U.S. gal.	175 sqft	18.9 L / 5.28 U.S. gal.	875 sqft
Colour	3mm Joints																										
Neutral, Stone Grey, Basalt <i>1 L / 5 gal</i>	50-150 sqft / 55 lb bag																										
Colour	3-4mm Joints																										
Neutral, Stone Grey, Basalt <i>55 lb bag / 1 kg can</i>	50-150 sqft / 55 lb mix																										
Colour	Narrow Joints	Wide Joints																									
Beige, Slate Grey <i>50 lb bag</i>	65-85 sqft	22-42 sqft																									
Size	Area																										
3.78 L / 1 U.S. gal.	175 sqft																										
18.9 L / 5.28 U.S. gal.	875 sqft																										

\*Please refer to Sands & Sealers on pages 190-202 for more detailed information.

Unsured of bonded vs. unbonded product recommendations? Please contact your Unilock Territory Manager for more information.

# COPTHORNE® Exclusive to **UNILOCK**



**ELEGANCE**



BURGUNDY RED



BURNT CLAY



BASALT



OLD OAK



3 COLOUR BLEND  
Sold separately / Blended on site

## VISUAL APPEARANCE

Inspired by the rich colour and timeworn beauty of European street pavers.

## FINISH

Timeworn. Reala™ Technology provides ultra-realistic textures cast from brick, cobblestone or flagstone.

## PRODUCT SPECIFICATIONS



**STANDARD**  
2½ x 7⅞ x 2⅜"  
65 x 200 x 60mm

## EDGE DETAILS

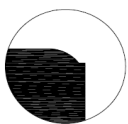

ROUNDED EDGE

## LAYING PATTERNS

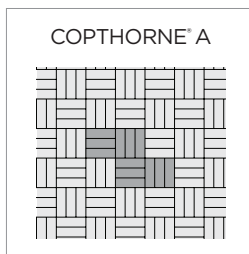

COPTHORNE A  
100% Standard

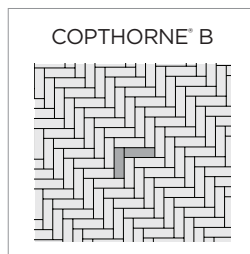

COPTHORNE B  
100% Standard

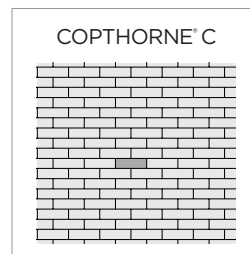

COPTHORNE C  
100% Standard

\*Colour selection should be chosen from actual samples.



**TECHNICAL INFORMATION**

**ASTM C 936 Standard Specifications for Solid Concrete Interlocking Paving Units**

Conforms to:

- C140 for Absorption 5% avg - 7% max
- C140 for Compressive Strength > 7,200 PSI avg.
- C67 for Freeze-thaw Durability
- C418 for Abrasion Durability
- Dimensional Accuracy **+/- 3 mm**

*Test results available upon request*

**Meets the U.S. Architectural & Transportation Barrier Compliance Board Slip-Resistance Surfaces Advisory Guidelines**

**LEED INFORMATION**

**Materials & Resources: LEED V4:**

- Building Product Disclosure and Optimization
- Sourcing of Raw Materials - Sourcing of Raw Materials and Extraction • **1 point**
- Sourcing of Raw Materials - Leadership Extraction Practices • **1 point**
- Material Ingredient Reporting - Material Ingredient Reporting • **1 point**
- Material Ingredient Reporting - Material Ingredient Optimization • **1 point**
- Environmental Product Declaration • **1 point**

**TECHNICAL ADVANTAGES**

**ELEGANCE**

Deep rich colours and unique textures

**REALA™**

Cast from historic brick

**ULTIMA™**

Up to 4x stronger than poured-in-place concrete

**DRIVE FRIENDLY**

Can handle vehicular loads

*Ask about our base stabilization system*

**PRODUCT DATA**

Stones & Bundling	Unit	SqFt Per				Per Bundle	Soldier LnFt Per			Sailor LnFt per			Units Per			Lbs Per		
	Thickness	Bundle	Layer	Section	Stone	Layers	Unit	Layer	Bundle	Unit	Layer	Bundle	SqFt	Section	Bundle	Layer	Section	Bundle
<b>Ayr Manufacturing</b>																		
Standard	2 3/8" (60mm)	89.20	11.15	-	0.15	8	0.21	-	127.95	0.66	-	393.75	6.73	-	600	294	-	2,349

Notes: Sold in full bundles only on a refundable skid. All measurements are nominal. **Important: A urethane rubber paver mat must be used to prevent scuffing.** For more information, samples or custom options, please contact your Unilock Territory Manager or call 1-800-UNILOCK.

**APPLICATIONS**



Pedestrian



Residential Vehicular





Commercial Vehicular



Borders and Accents



\*Wall pairing suggestion- U-CARA\*

RECOMMENDED SANDS			RECOMMENDED SEALER																						
 <p><b>Romex: Rompox® ECO-Fine</b> Pedestrian Applications only Vehicular when laid on a Trass Bed</p> <ul style="list-style-type: none"> <li>Ready mixed and easy to use</li> <li>Resin film free</li> <li>Resistant to ants, weeds, de-icing salts</li> <li>Made from 98% natural, recycled or renewable raw materials</li> <li>Pressure washer safe</li> <li>Ideal for joint widths from 5mm (1/4")</li> </ul> <p>Coverage:</p> <table border="1"> <thead> <tr> <th>Colour</th> <th>5-6mm Joints</th> </tr> </thead> <tbody> <tr> <td>Beige, Stone Grey, Anthracite 55 lb bag / 1 kg can</td> <td>125 sqft / 55 lb mix</td> </tr> </tbody> </table>			Colour	5-6mm Joints	Beige, Stone Grey, Anthracite 55 lb bag / 1 kg can	125 sqft / 55 lb mix	 <p><b>Alliance - Gator G2 MAXX Sand</b></p> <ul style="list-style-type: none"> <li>Rain safe after 15 minutes (24hr no rain if concrete overlay)</li> <li>Sets above 32° F/ 0° C - may vary depending on weather, drainage, bedding materials and installation</li> <li>Dust free and haze free</li> <li>Requires only one watering</li> </ul> <p>Coverage:</p> <table border="1"> <thead> <tr> <th>Colour</th> <th>Narrow Joints</th> <th>Wide Joints</th> </tr> </thead> <tbody> <tr> <td>Beige, Grey, Ivory 50 lb bag</td> <td>65-85 sqft</td> <td>22-42 sqft</td> </tr> <tr> <td>Black 50 lb bag</td> <td>58-76 sqft</td> <td>20-38 sqft</td> </tr> </tbody> </table>			Colour	Narrow Joints	Wide Joints	Beige, Grey, Ivory 50 lb bag	65-85 sqft	22-42 sqft	Black 50 lb bag	58-76 sqft	20-38 sqft	 <p><b>Alliance - Gator Seal Satin Look</b></p> <ul style="list-style-type: none"> <li>Solvent-based</li> <li>Low gloss finish</li> <li>Vibrant colour enhancer</li> <li>Rain safe after 90 minutes</li> <li>Helps resist corrosion from de-icing salt, ultra-violet rays effects, motor oils and grease stains</li> </ul> <p>Coverage:</p> <table border="1"> <thead> <tr> <th>Size</th> <th>Area</th> </tr> </thead> <tbody> <tr> <td>3.78 L / 1 U.S. gal.</td> <td>175 sqft</td> </tr> </tbody> </table>			Size	Area	3.78 L / 1 U.S. gal.	175 sqft
Colour	5-6mm Joints																								
Beige, Stone Grey, Anthracite 55 lb bag / 1 kg can	125 sqft / 55 lb mix																								
Colour	Narrow Joints	Wide Joints																							
Beige, Grey, Ivory 50 lb bag	65-85 sqft	22-42 sqft																							
Black 50 lb bag	58-76 sqft	20-38 sqft																							
Size	Area																								
3.78 L / 1 U.S. gal.	175 sqft																								

\*Please refer to Sands & Sealers on pages 190-202 for more detailed information.

Unsure of bonded vs. unbonded product recommendations? Please contact your Unilock Territory Manager for more information.



**ELEGANCE**



BASALT

## VISUAL APPEARANCE

Each cobble is uniquely formed to closely resemble authentic European cobblestones.

## FINISH

Timeworn. Real™ Technology provides ultra-realistic textures cast from brick, cobblestone or flagstone.

## PRODUCT SPECIFICATIONS



**XL RECTANGLE**

5⅞ x 8⅜ x 2⅜"  
130 x 215 x 60mm



**LARGE RECTANGLE**

5⅞ x 7¼ x 2⅜"  
130 x 185 x 60mm



**RECTANGLE**

5⅞ x 6½ x 2⅜"  
130 x 165 x 60mm



**SMALL RECTANGLE**

5⅞ x 5¾ x 2⅜"  
130 x 145 x 60mm



**SQUARE**

5⅞ x 5⅞ x 2⅜"  
130 x 130 x 60mm

5 UNIT RANDOM BUNDLE

## EDGE DETAILS



ROUNDED EDGE

## LAYING PATTERNS

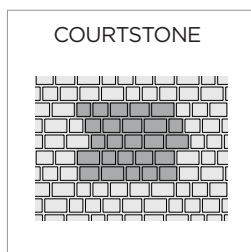

\*Colour selection should be chosen from actual samples.

**TECHNICAL INFORMATION**

**ASTM C 936 Standard Specifications for Solid Concrete Interlocking Paving Units**

Conforms to:

- C140 for Absorption 5% avg - 7% max
- C140 for Compressive Strength > 7,200 PSI avg.
- C67 for Freeze-thaw Durability
- C418 for Abrasion Durability
- Dimensional Accuracy **+/- 3 mm**

Test results available upon request

**Meets the U.S. Architectural & Transportation Barrier Compliance Board Slip-Resistance Surfaces Advisory Guidelines**

**LEED INFORMATION**

**Materials & Resources: LEED V4:**

- Building Product Disclosure and Optimization
- Sourcing of Raw Materials - Sourcing of Raw Materials and Extraction • **1 point**
- Sourcing of Raw Materials - Leadership Extraction Practices • **1 point**
- Material Ingredient Reporting - Material Ingredient Reporting • **1 point**
- Material Ingredient Reporting - Material Ingredient Optimization • **1 point**
- Environmental Product Declaration • **1 point**

**TECHNICAL ADVANTAGES**

**ELEGANCE™**

Deep rich colours and unique textures

**REALA™**

Cast from historic European cobblestones

**ULTIMA™**

Up to 4x stronger than poured-in-place concrete

**DRIVE FRIENDLY**

Random Bundle can handle vehicular loads  
Ask about our base stabilization system

**PRODUCT DATA**

Stones & Bundling	Unit Thickness	SqFt Per				Per Bundle		Soldier LnFt Per			Sailor LnFt per			Units Per			Lbs Per		
		Bundle	Layer	Section	Stone	Layers	Sections	Unit	Layer	Bundle	Unit	Layer	Bundle	SqFt	Layer	Bundle	Unit	Layer	Bundle
<b>Ayr Manufacturing</b>																			
Random Bundle		98.30	12.29	-	0.26	8	-	-	-	-	0.444	-	221.50	3.91	48	384	6.06	290.75	2,326
XL Rectangle	2 3/8" (60mm)	-	-	-	0.30	-	-	-	-	-	0.69	-	90.29	3.32	-	128	-	-	-
Large Rectangle	2 3/8" (60mm)	-	-	-	0.26	-	-	-	-	-	0.60	-	38.85	3.86	-	64	-	-	-
Rectangle	2 3/8" (60mm)	-	-	-	0.23	-	-	-	-	-	0.54	-	34.65	4.33	-	64	-	-	-
Small Rectangle	2 3/8" (60mm)	-	-	-	0.20	-	-	-	-	-	0.48	-	30.45	4.93	-	64	-	-	-
Square	2 3/8" (60mm)	-	-	-	0.18	-	-	-	-	-	0.43	-	27.30	5.50	-	64	-	-	-

Notes: Sold in full bundles only on a refundable skid. All measurements are nominal. **Important: A urethane rubber paver mat must be used to prevent scuffing.** For more information, samples or custom options, please contact your Unilock Territory Manager or call 1-800-UNILOCK.

**APPLICATIONS**



Pedestrian



Residential Vehicular



Borders and Accents



\*Wall pairing suggestion- U-CARA®

**RECOMMENDED SANDS**



**Romex: Rompox® ECO-Fine**  
Pedestrian Applications only

- | Ready mixed and easy to use
- | Resin film free
- | Resistant to ants, weeds, de-icing salts
- | Made from 98% natural, recycled or renewable raw materials
- | Pressure washer safe
- | Ideal for joint widths from 5mm (1/4")

**Coverage:**

Colour	5-6mm Joints
Beige, Stone Grey, Anthracite 55 lb bag / 1 kg can	125 sqft / 55 lb mix



**Romex: Rompox® Flex Joint**  
Vehicular Applications (unbonded)

- | Exclusive viscous elastic jointing mortar
- | Suitable for vehicular rated and unbonded surfaces
- | Water permeable
- | Pressure washer safe
- | Self compacting and water emulsifiable during installation
- | Designed to work in combination with the ISATec® displacement protection system

**Coverage:**

Colour	Up to 14mm Joints
Neutral, Stone Grey, Basalt 55 lb bag / 1 kg can	125 sqft / 55 lb bag



**Alliance Gator Nitro Joint Sand**  
Pedestrian Applications only

- | Ready mixed and easy to use
- | Permeable
- | Apply rain or shine
- | Hardens from top to bottom up to 2 3/8" (60mm)
- | Must be installed above 37°F (3°C)
- | Avoid power washing for 28 days after application
- | Ideal for joint widths from 3mm (1/8")

**Coverage:**

Colour	3 mm Joints
Beige, Silver, 40 lb bag / 18.1 kg Black Grey	84 sqft / 40lb bag 74 sqft 79 sqft



**Eurostone Bond**  
Pedestrian & Vehicular Applications

- | Setting time - 24 hours without rain for non-drainage base systems
- | Setting time - 1 hour without rain for drainage base systems
- | Sets above 32° F/ 0° C
- | Ideal for cobblestone and natural stone joints up to 1.5" (3.75cm)
- | One colour: Slate Grey

**Coverage:**

Size	Narrow Joints	Wide Joints
50 lb bag	65 - 85 sqft	22 - 42 sqft

\*Please refer to Sands & Sealers on pages 190-202 for more detailed information.

Unsure of bonded vs. unbonded product recommendations? Please contact your Unilock Territory Manager for more information.

# DURAFLOW<sup>®</sup>

 PERMEABLE

*\*Special Order only. Minimum qtys apply\**

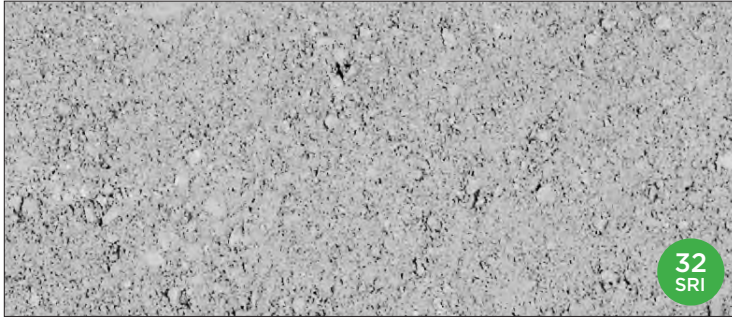

NATURAL



## VISUAL APPEARANCE

DuraFlow<sup>®</sup> is a specially designed permeable pavement with patented openings called 'cupules' that allow for fast cleaning of the joints using standard sweeping equipment.

## FINISH

This latest evolution of permeable pavement is suitable for heavy-duty applications and is ADA compliant.

## PRODUCT SPECIFICATIONS



9<sup>7</sup>/<sub>8</sub> x 9<sup>7</sup>/<sub>8</sub> x 3<sup>1</sup>/<sub>8</sub>"  
250 x 250 x 80mm

## EDGE DETAILS



ROUNDED EDGE

## PERMEABLE PAVEMENT DATA

				MIN. INFILTRATION RATE FOR RAINFALL OF:				
Large: 3/8" to 1/2" Joint	JOINT MATERIAL	JOINT WIDTH*	VOID SPACE*	SURFACE INFILTRATION RATE**	2" / HR	4.5" / HR	6.5" / HR	11" / HR
		ASTM #8 IDOT CA-16	12mm	8%	912" / HR	25	56	81

\*Joint Width is measured at the top of the paver. Void Space is calculated at the base of the paver. \*\*Infiltration rate is based on testing done when first installed and is an approximate. Permeable spacers are available for use with extended range of Unilock products.

\*Colour selection should be chosen from actual samples.

**TECHNICAL INFORMATION**

**ASTM C 936 Standard Specifications for Solid Concrete Interlocking Paving Units**

Conforms to:

- C140 for Absorption 5% avg - 7% max
  - Compressive Strength > 7,200 PSI avg.
  - C67 for Freeze-thaw Durability
  - C418 for Abrasion Durability
  - Dimensional Accuracy **+/- 3 mm**
- Test results available upon request*

**Meets the U.S. Architectural & Transportation Barrier Compliance Board Slip-Resistance Surfaces Advisory Guidelines**

**SOLAR REFLECTIVE INDEX (SRI) TESTING DETAILS**

Product	Solar Reflectance	SRI
Natural	0.30	32 

**LEED INFORMATION**

**Materials & Resources: LEED V4:**

- Building Product Disclosure and Optimization
- Sourcing of Raw Materials - Sourcing of Raw Materials and Extraction • **1 point**
- Sourcing of Raw Materials - Leadership Extraction Practices • **1 point**
- Material Ingredient Reporting - Material Ingredient Reporting • **1 point**
- Material Ingredient Reporting - Material Ingredient Optimization • **1 point**
- Environmental Product Declaration • **1 point**

**TECHNICAL ADVANTAGES**



Can be installed to allow water to flow through

**PRODUCT DATA**

Stones & Bundling	Unit	SqFt Per				Per Bundle		Soldier LnFt Per			Sailor LnFt per			Units Per			Lbs Per		
	Thickness	Bundle	Layer	Section	Stone	Layers	Sections	Unit	Section	Bundle	Unit	Section	Bundle	SqFt	Section	Bundle	Layer	Section	Bundle
<b>Pickering Manufacturing</b>																			
Random Bundle	3 1/8" (80 mm)	74.17	10.60	-	0.51	7	-	-	-	-	-	-	-	1.98	-	147	350	-	2,452

Notes: DuraFlow® can be manufactured in a variety of special order colours and textures. Minimum quantities will apply. For more information, samples or custom options, please contact your Unilock Territory Manager or call 1-800-UNILOCK.

**APPLICATIONS**



Permeable (Heavy Duty)



Pedestrian



Residential Vehicular



Commercial Vehicular

**RECOMMENDED SANDS**



**Romex: Rompox® - Flex Joint**

Pedestrian, Vehicular and Heavy Duty Vehicular Applications

- | Viscous elastic jointing mortar (sand and rubber)
- | Suitable for unbonded surfaces
- | Water permeable, self compacting and water emulsifiable during installation
- | Medium to heavy traffic up to 25 T
- | Three colours: Neutral, Stone Grey and Basalt



**Alliance Gator Aqua Rock**

Residential & Commercial Applications

- | For permeable paver joints
- | Helps prevent erosion due to climatic conditions
- | Use as bedding and jointing material
- | Graded to meet ASTM No. 9 water rate
- | Long term high infiltration performance
- | 2,200 lb Super Sack available for large applications

**Coverage:**

Colour	12mm Joints
Neutral, Stone Grey, Basalt <i>25 kg bucket / 55 lb bucket</i>	27 sqft / 55 lb bucket <i>(based on 1,000 sqft)</i>

**Coverage:**

Size	Area
50 lb bag	20-25 sqft
2,200 lb Super Sack	880-1100 sqft

(Based on 60mm paver)

\*Please refer to Sands & Sealers on pages 190-202 for more detailed information.

Unsure of bonded vs. unbonded product recommendations? Please contact your Unilock Territory Manager for more information.

# DURA-MAT

 **PERMEABLE**

*\*Special Order only. Minimum qtys apply\**

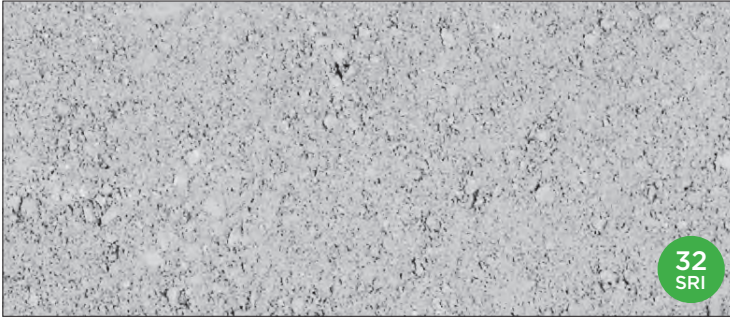

NATURAL

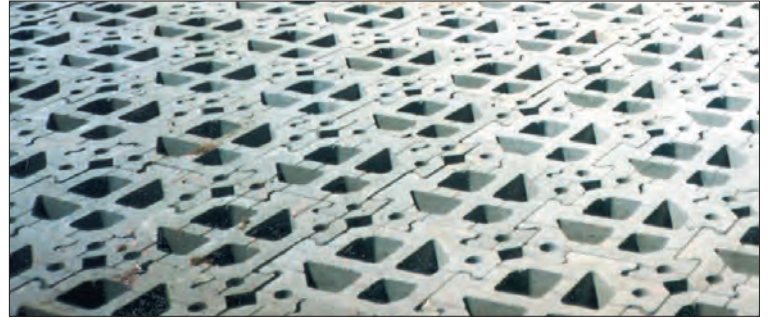

## VISUAL APPEARANCE

Dura-Mat's interlocking concrete units fasten together on all sides forming a permanent protective carpet. The interlocking system of Dura-Mat allows contouring to most terrain conditions.

## FINISH

The solid-to-void ratio also allows for vegetation growth where desired.

## PRODUCT SPECIFICATIONS



### STANDARD

19¾ x 19¾ x 4"

500 x 500 x 100mm

## EDGE DETAILS



ZERO-BEVEL EDGE

\*Colour selection should be chosen from actual samples.

**TECHNICAL INFORMATION**

**ASTM C 936 Standard Specifications for Solid Concrete Interlocking Paving Units**

Conforms to:

- C140 for Absorption 5% avg - 7% max
- Compressive Strength > 7,200 PSI avg.
- C67 for Freeze-thaw Durability
- C418 for Abrasion Durability
- Dimensional Accuracy +/- 3 mm

Test results available upon request

**Meets the U.S. Architectural & Transportation Barrier Compliance Board Slip-Resistance Surfaces Advisory Guidelines**

**SOLAR REFLECTIVE INDEX (SRI) TESTING DETAILS**

Product	Solar Reflectance	SRI
Natural	0.30	32 

**LEED INFORMATION**

**Materials & Resources: LEED V4:**

- Building Product Disclosure and Optimization
- Sourcing of Raw Materials - Sourcing of Raw Materials and Extraction • 1 point
- Sourcing of Raw Materials - Leadership Extraction Practices • 1 point
- Material Ingredient Reporting - Material Ingredient Reporting • 1 point
- Material Ingredient Reporting - Material Ingredient Optimization • 1 point
- Environmental Product Declaration • 1 point

**TECHNICAL ADVANTAGES**

 **PERMEABLE**

Can be installed to allow water to flow through

**PRODUCT DATA**

Stones & Bundling	Unit	SqFt Per				Per Bundle		Soldier LnFt Per			Sailor LnFt per			Units Per			Lbs Per		
	Thickness	Bundle	Layer	Section	Stone	Layers	Sections	Unit	Section	Bundle	Unit	Section	Bundle	SqFt	Section	Bundle	Layer	Section	Bundle
<b>Gormley Manufacturing</b>																			
Standard	4" (100mm)	78.40	11.20	-	2.80	7	-	-	-	-	-	-	-	0.36	-	28	320	-	2,242

Notes: Special Order item. Lead time required. Sold in full bundles only on a refundable skid. All measurements are nominal. For more information, samples or custom options, please contact your Unilock Territory Manager or call 1-800-UNILOCK.

**APPLICATIONS**



\*Dura-Mat is typically used in applications to reduce and control erosion. Commonly used at the base of, or entrances to, retention ponds.

**RECOMMENDED SAND**



**Alliance Gator Aqua Rock**  
Residential & Commercial Applications

- | For permeable paver joints
- | Helps prevent erosion due to climatic conditions
- | Use as bedding and jointing material
- | Graded to meet ASTM No. 9 water rate
- | Long term high infiltration performance
- | 2,200 lb Super Sack available for large applications

**Coverage:**

Size	Area
50 lb bag	20-25 sqft
2,200 lb Super Sack	880-1100 sqft

(Based on 60mm paver)

\*Please refer to Sands & Sealers on pages 190-202 for more detailed information.

Unsure of bonded vs. unbonded product recommendations? Please contact your Unilock Territory Manager for more information.

# ECO-LINE®

 PERMEABLE



*\*Special Order only. Minimum qtys apply\**



Eco-Line® is a **SPECIAL ORDER ONLY PRODUCT** and can be manufactured in a variety of custom colours and textures. Minimum quantities may apply. Please contact your Unilock Territory Manager for more details.

## VISUAL APPEARANCE

Long and narrow design facilitates a linear laying pattern resulting in a finished and sleek appearance for any permeable, heavy duty application.

## FINISH

Available in a variety of Unilock Select finishes.

## PRODUCT SPECIFICATIONS



3 x 9 x 4"  
84 x 237 x 100mm



3 x 11 x 4"  
84 x 277 x 100mm



3 x 12½ x 4"  
84 x 317 x 100mm



3 x 14 x 4"  
84 x 357 x 100 mm



4½ x 9 x 4"  
114 x 237 x 100mm



4½ x 11 x 4"  
114 x 277 x 100mm



4½ x 12½ x 4"  
114 x 317 x 100mm



4½ x 14 x 4"  
114 x 357 x 100mm

8 UNIT RANDOM BUNDLE

## EDGE DETAILS



ROUNDED EDGE

## LAYING PATTERNS

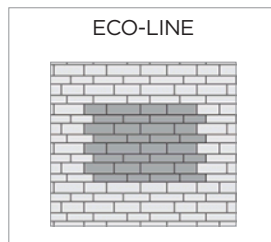

## PERMEABLE PAVEMENT DATA

PERMEABLE PAVEMENT DATA				MIN. INFILTRATION RATE FOR RAINFALL OF:				
Small: 1/4" Joint	JOINT MATERIAL	JOINT WIDTH*	VOID SPACE*	SURFACE INFILTRATION RATE**	2" / HR	4.5" / HR	6.5" / HR	11" / HR
		ASTM #9 Aqua Rock	6.25mm	5.8%	560" / HR	34	78	112

\*Joint Width is measured at the top of the paver. Void Space is calculated at the base of the paver. \*\*Infiltration rate is based on testing done when first installed and is an approximate. Permeable spacers are available for use with extended range of Unilock products.

\*Colour selection should be chosen from actual samples.



**TECHNICAL INFORMATION**

**ASTM C 936 Standard Specifications for Solid Concrete Interlocking Paving Units**

- Conforms to:
- C140 for Absorption 5% avg - 7% max
  - Compressive Strength > 7,200 PSI avg.
  - C67 for Freeze-thaw Durability
  - C418 for Abrasion Durability
  - Dimensional Accuracy **+/- 3 mm**
- Test results available upon request*

Meets the U.S. Architectural & Transportation Barrier Compliance Board Slip-Resistance Surfaces Advisory Guidelines

**LEED INFORMATION**

**Materials & Resources: LEED V4:**

- Building Product Disclosure and Optimization
- Sourcing of Raw Materials - Sourcing of Raw Materials and Extraction • **1 point**
- Sourcing of Raw Materials - Leadership Extraction Practices • **1 point**
- Material Ingredient Reporting - Material Ingredient Reporting • **1 point**
- Material Ingredient Reporting - Material Ingredient Optimization • **1 point**
- Environmental Product Declaration • **1 point**

**TECHNICAL ADVANTAGES**



Can be installed to allow water to flow through

**DRIVE FRIENDLY**

Can handle vehicular loads  
*Ask about our base stabilization system*

**PRODUCT DATA**

Stones & Bundling	Unit Thickness	SqFt Per				Per Bundle		Soldier LnFt Per			Sailor LnFt per			Units Per			Lbs Per		
		Bundle	Layer	Section	Stone	Layers	Sections	Unit	Section	Bundle	Unit	Section	Bundle	SqFt	Section	Bundle	Layer	Section	Bundle
<b>Pickering Manufacturing</b>																			
Random Bundle	4" (100mm)	66.20	11.03	-	0.34	6	-	-	-	-	-	-	-	2.90	-	192	504	-	3,027
Large 11.4	4" (100mm)	-	-	-	0.39	-	-	-	-	-	-	-	-	2.57	-	24	-	-	-
Large 8.4	4" (100mm)	-	-	-	0.29	-	-	-	-	-	-	-	-	3.49	-	24	-	-	-
Medium 11.4	4" (100mm)	-	-	-	0.34	-	-	-	-	-	-	-	-	2.94	-	24	-	-	-
Medium 8.4	4" (100mm)	-	-	-	0.25	-	-	-	-	-	-	-	-	3.99	-	24	-	-	-
Small 11.4	4" (100mm)	-	-	-	0.29	-	-	-	-	-	-	-	-	3.44	-	24	-	-	-
Small 8.4	4" (100mm)	-	-	-	0.21	-	-	-	-	-	-	-	-	4.67	-	24	-	-	-
XL 11.4	4" (100mm)	-	-	-	0.44	-	-	-	-	-	-	-	-	2.28	-	24	-	-	-
XL 8.4	4" (100mm)	-	-	-	0.32	-	-	-	-	-	-	-	-	3.10	-	24	-	-	-

Notes: Special Order only - multiple finish and colour options are available. All measurements are nominal. **Important: A urethane rubber paver mat must be used to prevent scuffing. Approved for vehicular applications. All measurements are nominal.** For more information, samples or custom options, please contact your Unilock Territory Manager or call 1-800-UNILOCK.

**APPLICATIONS**



Permeable (Heavy Duty)



Pedestrian



Residential Vehicular



Commercial Vehicular

**RECOMMENDED SANDS**



**Romex: Rompox® Pure Patio**  
Pedestrian Applications only

- Resin film-free
- Highly water permeable
- Resistant to ants, weeds, de-icing salts
- Pressure washer safe
- Ideal for joint widths from 5mm (1/4")
- Ideal for Residential patios and walkways
- Three colours: Neutral, Stone Grey and Basalt

Coverage:

Colour	6mm Joints
Neutral, Stone Grey, Basalt <i>55 lb bag / 1 kg can</i>	25 sqft / 55 lb mix <i>(based on 1,000 sqft)</i>



**Romex: Rompox® Drain**  
Vehicular Applications

- Resin film-free
- Highly water permeable
- Self-compacting and water emulsifiable
- Resistant to ants, weeds, de-icing salts
- Pressure washer safe
- Ideal for joint widths from 3mm (1/4")
- Ideal for driveways, parking spaces and all vehicular loading applications up to 3.5 T
- Three colours: Neutral, Stone Grey and Basalt

Coverage:

Colour	6mm Joints
Neutral, Stone Grey, Basalt <i>Two 1 L bottles to be mixed with one 55 lb bag of Romex approved sand</i>	25 sqft / 55 lb mix <i>(based on 1,000 sqft)</i>



**Romex: Rompox® D1**  
Heavy Duty Vehicular Applications

- Light to medium vehicle rated
- Increased pouring capacity that is self-compacting and water emulsifiable
- Resistant to ants, weeds, de-icing salts
- Pressure washer safe
- Ideal for joint widths from 3mm (1/8")
- Ideal for driveways, parking spaces and all vehicular loading applications up to 7.5 T
- Three colours: Neutral, Stone Grey and Basalt

Coverage:

Colour	6mm Joints
Neutral, Stone Grey, Basalt <i>Two 1.5 L bottles to be mixed with one 55 lb bag of Romex approved sand</i>	25 sqft / 55 lb mix <i>(based on 1,000 sqft)</i>



**Alliance Gator Aqua Rock**  
Residential & Commercial Applications

- For permeable paver joints
- Helps prevent erosion due to climatic conditions
- Use as bedding and jointing material
- Graded to meet ASTM No. 9 water rate
- Long term high infiltration performance
- 2,200 lb Super Sack available for large applications

Coverage:

Size	Area
50 lb bag	20-25 sqft
2,200 lb Super Sack	880-1100 sqft

\*Please refer to Sands & Sealers on pages 190-202 for more detailed information.

Unsure of bonded vs. unbonded product recommendations? Please contact your Unilock Territory Manager for more information.

# ECO-OPTILOC™

 PERMEABLE

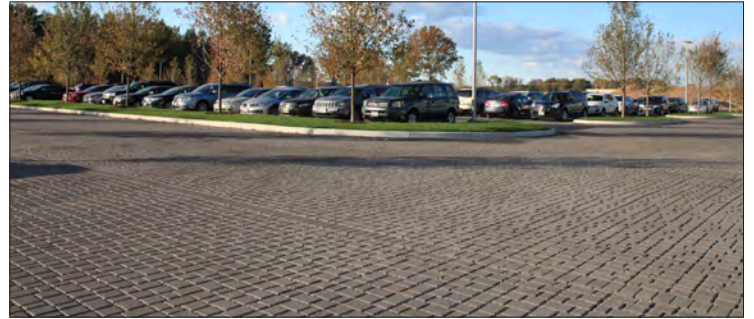

NATURAL

## VISUAL APPEARANCE

This paver has gained world-wide acceptance as the paver-of-choice for performance, and as an environmental solution for drainage. Only the patented "L" shaped design allows you to achieve a superior lock-up that can withstand even the heaviest of loads residentially and commercially.

## FINISH

The innovative design creates small voids between the pavers providing drainage into the sub-base.

## PRODUCT SPECIFICATIONS



10¼ x 10¼ x 3⅞"  
250 x 250 x 80mm

*Eco-Optiloc™ can be machine laid to allow for ease of installation.*

## EDGE DETAILS



CHAMFERED

## LAYING PATTERNS

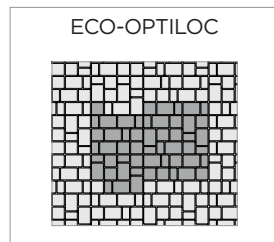

## PERMEABLE PAVEMENT DATA

Large: 3/8" to 1/2" Joint	JOINT MATERIAL	JOINT WIDTH*	VOID SPACE*	SURFACE INFILTRATION RATE**	MIN. INFILTRATION RATE FOR RAINFALL OF:			
					2" / HR	4.5" / HR	6.5" / HR	11" / HR
	HPB	12mm	7.3%	404" / HR	27	62	89	151
	ASTM #8 IDOT CA-16	12mm	7.3%	912" / HR	27	62	89	151

\*Joint Width is measured at the top of the paver. Void Space is calculated at the base of the paver. \*\*Infiltration rate is based on testing done when first installed and is an approximate. Permeable spacers are available for use with extended range of Unilock products.

\*Colour selection should be chosen from actual samples.

**TECHNICAL INFORMATION**

**ASTM C 936 Standard Specifications for Solid Concrete Interlocking Paving Units**

- Conforms to:
- C140 for Absorption 5% avg - 7% max
  - Compressive Strength > 7,200 PSI avg.
  - C67 for Freeze-thaw Durability
  - C418 for Abrasion Durability
  - Dimensional Accuracy **+/- 3 mm**
- Test results available upon request*

**Meets the U.S. Architectural & Transportation Barrier Compliance Board Slip-Resistance Surfaces Advisory Guidelines**

**SOLAR REFLECTIVE INDEX (SRI) TESTING DETAILS**

Product	Solar Reflectance	SRI
Natural	0.30	32 

**LEED INFORMATION**

**Materials & Resources: LEED V4:**

- Building Product Disclosure and Optimization
- Sourcing of Raw Materials - Sourcing of Raw Materials and Extraction • **1 point**
- Sourcing of Raw Materials - Leadership Extraction Practices • **1 point**
- Material Ingredient Reporting - Material Ingredient Reporting • **1 point**
- Material Ingredient Reporting - Material Ingredient Optimization • **1 point**
- Environmental Product Declaration • **1 point**

**TECHNICAL ADVANTAGES**

 **PERMEABLE**

Can be installed to allow water to flow through

**CLASSIC**

Budget-friendly. Utilizes a traditional product mix of large and small aggregates that's consistent from top to bottom with colour mixed throughout

**DRIVE FRIENDLY**

Can handle vehicular loads  
*Ask about our base stabilization system*

**PRODUCT DATA**

Stones & Bundling	Unit	SqFt Per					Per Bundle		Soldier LnFt Per			Sailor LnFt per			Units Per			Lbs Per		
	Thickness	Bundle	Layer	Section	Stone	Layers	Sections	Unit	Section	Bundle	Unit	Section	Bundle	SqFt	Section	Bundle	Layer	Section	Bundle	
<b>Gormley Manufacturing</b>																				
Standard	3/8" (80mm)	75.36	9.42	-	0.50	8	-	-	-	-	-	-	-	1.98	-	152	321	-	2,614	

Notes: This product is optimized for mechanical installation. Product is sold in full bundles only on a refundable skid. **Eco-Optiloc is available in Series™ and Il Campo® finishes. Custom colours are also available. Minimum quantities apply on custom orders.** All measurements are nominal. For more information, samples or custom options, please contact your Unilock Territory Manager or call 1-800-UNILOCK.

**APPLICATIONS**

-  Permeable (Heavy Duty)
-  Pedestrian
-  Residential Vehicular
-  Commercial Vehicular

**RECOMMENDED SANDS**



**Romex: Rompox® Flex Joint**  
Pedestrian, Vehicular and Heavy Duty Vehicular Applications

- | Viscous elastic jointing mortar (sand and rubber)
- | Suitable for vehicular rated and unbonded surfaces
- | Water permeable, self compacting and water emulsifiable during installation
- | Medium to heavy traffic up to 25 T
- | Three colours: Neutral, Stone Grey and Basalt

**Coverage:**

Colour	12mm Joints
Neutral, Stone Grey, Basalt 25 kg bucket / 55 lb bucket	27 sqft / 55 lb bucket <i>(based on 1,000 sqft)</i>



**Alliance Gator Aqua Rock**  
Residential & Commercial Applications

- | For permeable paver joints
- | Helps prevent erosion due to climatic conditions
- | Use as bedding and jointing material
- | Graded to meet ASTM No. 9 water rate
- | Long term high infiltration performance
- | 2,200 lb Super Sack available for large applications

**Coverage:**

Size	Area
50 lb bag	20-25 sqft
2,200 lb Super Sack	880-1100 sqft

*(Based on 60mm paver)*

\*Please refer to Sands & Sealers on pages 190-202 for more detailed information.

Unsure of bonded vs. unbonded product recommendations? Please contact your Unilock Territory Manager for more information.

# ECO-PRIORA™

ENDURACOLOR™ PERMEABLE

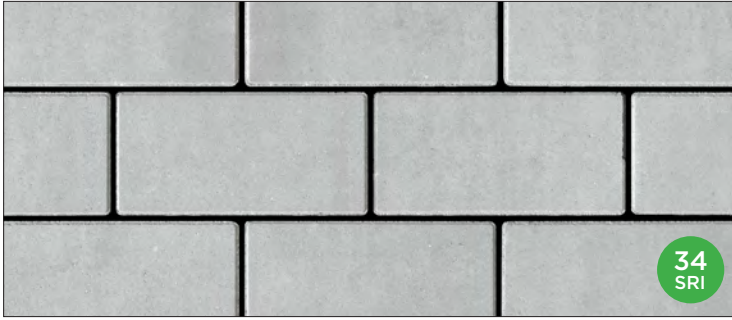

OPAL BLEND



STEEL GREY BLEND

## VISUAL APPEARANCE

Available in multiple shapes, this permeable paver can be produced using EnduraColor™ technology which increases the durability of the product and provides better colour retention. Custom colours and finishes are available to offer unlimited design possibilities.

## FINISH

Smooth, contemporary finish. By special order, you may select from a variety of standard and architectural finishes; Premier (smooth), Il Campo (brushed), Series (exposed aggregate) and Umbriano (mottled).

## PRODUCT SPECIFICATIONS



**RECTANGLE**  
5 x 10 x 3/8"  
120 x 240 x 80mm

*Special Order. Min. qtys apply.*



**LARGE SQUARE**  
10 x 10 x 3/8"  
240x 240 x 80mm



**SMALL SQUARE**  
5 x 5 x 3/8"  
120 x 120 x 80mm

## EDGE DETAILS



ROUNDED EDGE

## LAYING PATTERNS

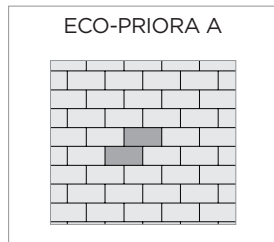

ECO-PRIORA A  
100% 5x10

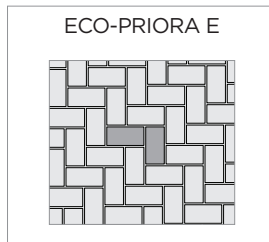

ECO-PRIORA E  
100% 5x10

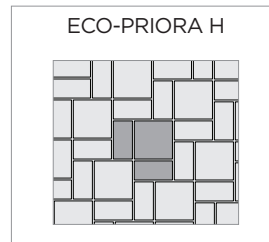

ECO-PRIORA H  
50% 5x10, 50% 10x10

## PERMEABLE PAVEMENT DATA

PAVER SIZE & PATTERN	JOINT MATERIAL	JOINT WIDTH*	VOID SPACE*	SURFACE INFILTRATION RATE**	MIN. INFILTRATION RATE FOR RAINFALL OF:			
					2" / HR	4.5" / HR	6.5" / HR	11" / HR
HERRINGBONE	ASTM #9- SEK Chip	7mm	7.08%	676" / HR	28	64	92	155
5 x 10	Kafka - 1/8 to 3/16"	7mm	6.8%	633" / HR	29	66	96	162
Pattern H	ASTM #9- Roscoe Chip	7mm	5.7%	509" / HR	35	79	114	193
Pattern H	IDOT FA 22	7mm	5.7%	347" / HR	35	79	114	193
10 x 10	Kafka - 1/16 to 3/16"	7mm	4.6%	327" / HR	43	98	141	239

\*Joint Width is measured at the top of the paver. Void Space is calculated at the base of the paver. \*\*Infiltration rate is based on testing done when first installed and is an approximate. Permeable spacers are available for use with extended range of Unilock products.

\*Colour selection should be chosen from actual samples.



TECHNICAL INFORMATION

ASTM C 936 Standard Specifications for Solid Concrete Interlocking Paving Units

- Conforms to:
- C140 for Absorption 5% avg - 7% max
  - Compressive Strength > 7,200 PSI avg.
  - C67 for Freeze-thaw Durability
  - C418 for Abrasion Durability
  - Dimensional Accuracy +/- 3 mm
- Test results available upon request

Meets the U.S. Architectural & Transportation Barrier Compliance Board Slip-Resistance Surfaces Advisory Guidelines

SOLAR REFLECTIVE INDEX (SRI) TESTING DETAILS

Product	Solar Reflectance	SRI
Opal Blend <i>Special Order</i>	0.32	34 
Steel Grey Blend <i>Special Order</i>	0.12	9 

TECHNICAL ADVANTAGES

ENDURACOLOR™

Refined surface and long-lasting colour

DRIVE FRIENDLY

Can handle vehicular loads  
Ask about our base stabilization system



PERMEABLE

Can be installed to allow water to flow through

LEED INFORMATION

Materials & Resources: LEED V4:

- Building Product Disclosure and Optimization
- Sourcing of Raw Materials - Sourcing of Raw Materials and Extraction • 1 point
- Sourcing of Raw Materials - Leadership Extraction Practices • 1 point
- Material Ingredient Reporting - Material Ingredient Reporting • 1 point
- Material Ingredient Reporting - Material Ingredient Optimization • 1 point
- Environmental Product Declaration • 1 point

PRODUCT DATA

Stones & Bundling	Unit	SqFt Per				Per Bundle		Soldier LnFt Per			Sailor LnFt per			Units Per			Lbs Per		
	Thickness	Bundle	Layer	Section	Stone	Layers	Sections	Unit	Section	Bundle	Unit	Section	Bundle	SqFt	Section	Bundle	Layer	Section	Bundle
<b>Pickering Manufacturing</b>																			
Rectangle	3 1/8" (80mm)	75.95	10.85	-	0.30	7	-	0.39	-	96.50	0.77	-	192.90	3.23	-	245	381	-	2,669

Notes: Sold in full bundles only on a refundable skid. Eco-Priora is also available in Series™, Il Campo® and Umbriano® finishes as a custom order. Minimum quantities apply on custom orders. All measurements are nominal. Specially designed aggregates must be used for the joints. For more information, samples or custom options, please contact your Unilock Territory Manager or call 1-800-UNILOCK.

APPLICATIONS



Permeable (Heavy Duty)



Pedestrian



Residential Vehicular



Commercial Vehicular



Borders and Accents



Roof Deck

RECOMMENDED SANDS



**Romex: Rompox® Drain**  
Pedestrian Applications only  
Vehicular when laid on a Trass Bed

- Resin film-free
- Highly water permeable
- Self-compacting and water emulsifiable
- Resistant to ants, weeds, de-icing salts
- Pressure washer safe
- Ideal for joint widths from 3mm (1/4")
- Ideal for driveways, parking spaces and all vehicular loading applications up to 3.5 T
- Three colours: Neutral, Stone Grey and Basalt

Coverage:

Colour	7mm Joints
Neutral, Stone Grey, Basalt <i>Two 1 L bottles to be mixed with one 55 lb bag of Romex approved sand</i>	45 sqft / 55 lb mix (based on 1,000 sqft)



**Romex: Rompox® Flex Joint**  
Pedestrian, Vehicular and Heavy Duty  
Vehicular Applications

- Viscous elastic jointing mortar (sand and rubber)
- Suitable for vehicular rated and unbonded surfaces
- Water permeable, self compacting and water emulsifiable during installation
- Medium to heavy traffic up to 25 T
- Three colours: Neutral, Stone Grey and Basalt

Coverage:

Colour	12mm Joints
Neutral, Stone Grey, Basalt <i>25 kg bucket / 55 lb bucket</i>	27 sqft / 55 lb bucket (based on 1,000 sqft)



**Alliance Gator Aqua Rock**  
Residential & Commercial  
Applications

- For permeable paver joints
- Helps prevent erosion due to climatic conditions
- Use as bedding and jointing material
- Graded to meet ASTM No. 9 water rate
- Long term high infiltration performance
- 2,200 lb Super Sack available for large applications

Coverage:

Size	Area
50 lb bag	20-25 sqft
2,200 lb Super Sack	880-1100 sqft

\*Please refer to Sands & Sealers on pages 190-202 for more detailed information.

Unsured of bonded vs. unbonded product recommendations? Please contact your Unilock Territory Manager for more information.

# ECO-PROMENADE®

ENDURACOLOR™ PERMEABLE



OPAL BLEND

Other finishes available: Il Campo®, Series™ & Umbriano®.



## VISUAL APPEARANCE

Long, linear look and feel for any contemporary permeable application.

## FINISH

By special order, you may select from a variety of standard and architectural finishes; Premier (*smooth*), Il Campo® (*brushed*), Series™ (*exposed aggregate*) and Umbriano® (*mottled*).

## PRODUCT SPECIFICATIONS



2<sup>7</sup>/<sub>8</sub> x 12 x 4"  
75 x 300 x 100mm

## EDGE DETAIL



ROUNDED EDGE

## LAYING PATTERNS

ECO-PROMENADE B

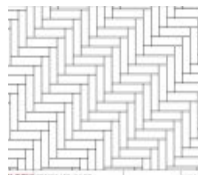

## PERMEABLE PAVEMENT DATA

Small: 1/4" Joint	JOINT MATERIAL	JOINT WIDTH*	VOID SPACE*	SURFACE INFILTRATION RATE**	MIN. INFILTRATION RATE FOR RAINFALL OF:			
					2" / HR	4.5" / HR	6.5" / HR	11" / HR
	ASTM #9 SEK Chip	7mm	10.12%	934" / HR	20	44	64	109

\*Joint Width is measured at the top of the paver. Void Space is calculated at the base of the paver. \*\*Infiltration rate is based on testing done when first installed and is an approximate. Permeable spacers are available for use with extended range of Unilock products.

\*Colour selection should be chosen from actual samples.

**TECHNICAL INFORMATION**

**ASTM C 936 Standard Specifications for Solid Concrete Interlocking Paving Units**

- Conforms to:
- C140 for Absorption 5% avg - 7% max
  - Compressive Strength > 7,200 PSI avg.
  - C67 for Freeze-thaw Durability
  - C418 for Abrasion Durability
  - Dimensional Accuracy **+/- 3 mm**
- Test results available upon request*

**Meets the U.S. Architectural & Transportation Barrier Compliance Board Slip-Resistance Surfaces Advisory Guidelines**

**SOLAR REFLECTIVE INDEX (SRI) TESTING DETAILS**

Product	Solar Reflectance	SRI
Opal Blend	0.32	34 

**LEED INFORMATION**

**Materials & Resources: LEED V4:**

- Building Product Disclosure and Optimization
- Sourcing of Raw Materials - Sourcing of Raw Materials and Extraction • **1 point**
- Sourcing of Raw Materials - Leadership Extraction Practices • **1 point**
- Material Ingredient Reporting - Material Ingredient Reporting • **1 point**
- Material Ingredient Reporting - Material Ingredient Optimization • **1 point**
- Environmental Product Declaration • **1 point**

**TECHNICAL ADVANTAGES**

**ENDURACOLOR™**

Refined surface and long-lasting colour

**DRIVE FRIENDLY**

Can handle vehicular loads  
*Ask about our base stabilization system*

 **PERMEABLE**

Can be installed to allow water to flow through

**PRODUCT DATA**

Stones & Bundling	Unit Thickness	SqFt Per				Per Bundle		Soldier LnFt Per			Sailor LnFt per			Units Per			Lbs Per		
		Bundle	Layer	Section	Stone	Layers	Sections	Unit	Section	Bundle	Unit	Section	Bundle	SqFt	Section	Bundle	Layer	Section	Bundle
<b>Georgetown Manufacturing</b>																			
2 7/8" x 12" Permeable	4" (100mm)	53.28	10.66	-	0.24	5	-	0.25	-	54.13	0.92	-	216.50	4.13	-	220	488	-	2,439

Notes: **Sold in full bundles only and is produced and sold on a required, refundable skid.** Custom finish and colour options are available. **Special order - lead time is required.** Minimum quantities apply. \*Weights vary depending on plant of manufacture & finish. **Important: A urethane rubber paver mat must be used to prevent scuffing.** For permeable installations, Unilock recommends using granite chips for joint filler. All measurements are nominal. For more information, samples or custom options, please contact your Unilock Territory Manager or call 1-800-UNILOCK.

**APPLICATIONS**



Permeable (Heavy Duty)



Pedestrian



Residential Vehicular



Commercial Vehicular







Borders and Accents



\*Wall pairing suggestion- U-CARA® Wall -matching colour and finish

**RECOMMENDED SANDS**

 <p><b>Romex: Rompox® Pure Patio</b> <i>Pedestrian Applications only</i></p> <ul style="list-style-type: none"> <li>  Resin film-free</li> <li>  Highly water permeable</li> <li>  Resistant to ants, weeds, de-icing salts</li> <li>  Pressure washer safe</li> <li>  Ideal for joint widths from 5mm (1/4")</li> <li>  Ideal for Residential patios and walkways</li> <li>  Three colours: Neutral, Stone Grey and Basalt</li> </ul> <p><b>Coverage:</b></p> <table border="1" style="width: 100%; border-collapse: collapse;"> <thead> <tr> <th>Colour</th> <th>7mm Joints</th> </tr> </thead> <tbody> <tr> <td>Neutral, Stone Grey, Basalt <i>55 lb bag / 1 kg can</i></td> <td>20 sqft / 55 lb mix <i>(based on 1,000 sqft)</i></td> </tr> </tbody> </table>	Colour	7mm Joints	Neutral, Stone Grey, Basalt <i>55 lb bag / 1 kg can</i>	20 sqft / 55 lb mix <i>(based on 1,000 sqft)</i>	 <p><b>Romex: Rompox® Drain</b> <i>Vehicular Applications</i></p> <ul style="list-style-type: none"> <li>  Resin film-free</li> <li>  Highly water permeable</li> <li>  Self-compacting and water emulsifiable</li> <li>  Resistant to ants, weeds, de-icing salts</li> <li>  Pressure washer safe</li> <li>  Ideal for joint widths from 3mm (1/4")</li> <li>  Ideal for driveways, parking spaces and all vehicular loading applications up to 3.5 T</li> <li>  Three colours: Neutral, Stone Grey and Basalt</li> </ul> <p><b>Coverage:</b></p> <table border="1" style="width: 100%; border-collapse: collapse;"> <thead> <tr> <th>Colour</th> <th>7mm Joints</th> </tr> </thead> <tbody> <tr> <td>Neutral, Stone Grey, Basalt <i>Two 1 L bottles to be mixed with one 55 lb bag of Romex approved sand</i></td> <td>20 sqft / 55 lb mix <i>(based on 1,000 sqft)</i></td> </tr> </tbody> </table>	Colour	7mm Joints	Neutral, Stone Grey, Basalt <i>Two 1 L bottles to be mixed with one 55 lb bag of Romex approved sand</i>	20 sqft / 55 lb mix <i>(based on 1,000 sqft)</i>	 <p><b>Romex: Rompox® D1</b> <i>Heavy Duty Vehicular Applications</i></p> <ul style="list-style-type: none"> <li>  Light to medium vehicle rated</li> <li>  Increased pouring capacity that is self-compacting and water emulsifiable</li> <li>  Resistant to ants, weeds, de-icing salts</li> <li>  Pressure washer safe</li> <li>  Ideal for joint widths from 3mm (1/8")</li> <li>  Ideal for driveways, parking spaces and all vehicular loading applications up to 7.5 T</li> <li>  Three colours: Neutral, Stone Grey and Basalt</li> </ul> <p><b>Coverage:</b></p> <table border="1" style="width: 100%; border-collapse: collapse;"> <thead> <tr> <th>Colour</th> <th>7mm Joints</th> </tr> </thead> <tbody> <tr> <td>Neutral, Stone Grey, Basalt <i>Two 1.5 L bottles to be mixed with one 55 lb bag of Romex approved sand</i></td> <td>20 sqft / 55 lb mix <i>(based on 1,000 sqft)</i></td> </tr> </tbody> </table>	Colour	7mm Joints	Neutral, Stone Grey, Basalt <i>Two 1.5 L bottles to be mixed with one 55 lb bag of Romex approved sand</i>	20 sqft / 55 lb mix <i>(based on 1,000 sqft)</i>	 <p><b>Alliance Gator Aqua Rock</b> <i>Residential &amp; Commercial Applications</i></p> <ul style="list-style-type: none"> <li>  For permeable paver joints</li> <li>  Helps prevent erosion due to climatic conditions</li> <li>  Use as bedding and jointing material</li> <li>  Graded to meet ASTM No. 9 water rate</li> <li>  Long term high infiltration performance</li> <li>  2,200 lb Super Sack available for large applications</li> </ul> <p><b>Coverage:</b></p> <table border="1" style="width: 100%; border-collapse: collapse;"> <thead> <tr> <th>Size</th> <th>Area</th> </tr> </thead> <tbody> <tr> <td>50 lb bag</td> <td>20-25 sqft</td> </tr> <tr> <td>2,200 lb Super Sack</td> <td>880-1100 sqft</td> </tr> </tbody> </table>	Size	Area	50 lb bag	20-25 sqft	2,200 lb Super Sack	880-1100 sqft
Colour	7mm Joints																				
Neutral, Stone Grey, Basalt <i>55 lb bag / 1 kg can</i>	20 sqft / 55 lb mix <i>(based on 1,000 sqft)</i>																				
Colour	7mm Joints																				
Neutral, Stone Grey, Basalt <i>Two 1 L bottles to be mixed with one 55 lb bag of Romex approved sand</i>	20 sqft / 55 lb mix <i>(based on 1,000 sqft)</i>																				
Colour	7mm Joints																				
Neutral, Stone Grey, Basalt <i>Two 1.5 L bottles to be mixed with one 55 lb bag of Romex approved sand</i>	20 sqft / 55 lb mix <i>(based on 1,000 sqft)</i>																				
Size	Area																				
50 lb bag	20-25 sqft																				
2,200 lb Super Sack	880-1100 sqft																				

\*Please refer to Sands & Sealers on pages 190-202 for more detailed information.

Unsure of bonded vs. unbanded product recommendations? Please contact your Unilock Territory Manager for more information.

# GRANITO™

Exclusive to **JNILOCK**

## ENDURACOLOR™



NOTTE *Random Bundle*



SABIA *Random Bundle*



SCURO *Random Bundle*

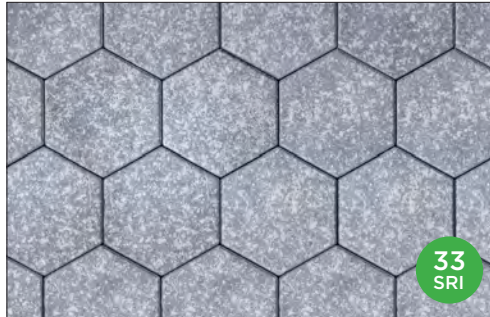

NOTTE *Hex*

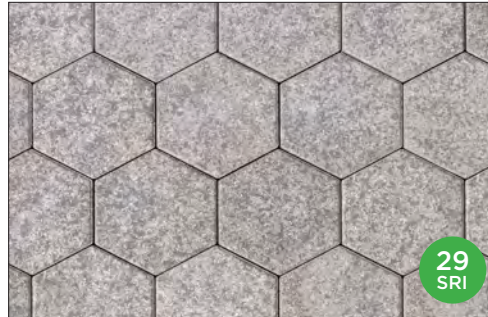

SABIA *Hex*

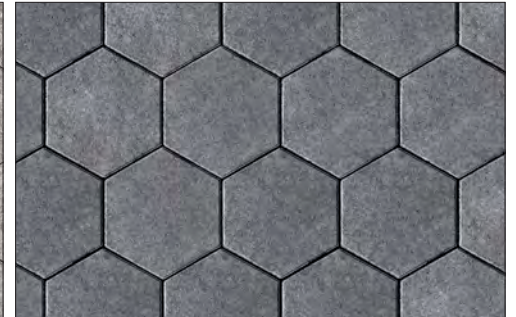

SCURO *Hex*

### VISUAL APPEARANCE

Mottled, flecked. Hex shape is a modern twist on the traditional shape.

### FINISH

Boldly mottled colour finish.

### PRODUCT SPECIFICATIONS



**LARGE RECTANGLE**  
14 x 21 x 2<sup>3</sup>/<sub>8</sub>"  
360 x 540 x 60mm



**SQUARE**  
14 x 14 x 2<sup>3</sup>/<sub>8</sub>"  
360 x 360 x 60mm



**SMALL RECTANGLE**  
7 x 14 x 2<sup>3</sup>/<sub>8</sub>"  
180 x 360 x 60mm



**HEX UNIT**  
8 x 8 x 2<sup>3</sup>/<sub>4</sub>"  
200 x 200 x 70mm  
*Sold separately*

3 UNIT BUNDLE

Random Bundle not recommended for vehicular  
Hex unit can handle vehicular loads

### EDGE DETAILS



ROUNDED EDGE

### BUNDLE CONFIGURATION

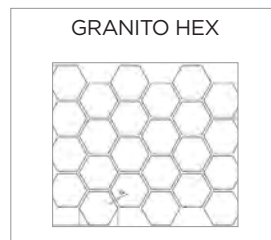

\*Colour selection should be chosen from actual samples.





**TECHNICAL INFORMATION**

**ASTM C 936 Standard Specifications for Solid Concrete Interlocking Paving Units**

- Conforms to:
- C140 for Absorption 5% avg - 7% max
  - Compressive Strength > 7,200 PSI avg.
  - C67 for Freeze-thaw Durability
  - C418 for Abrasion Durability
  - Dimensional Accuracy **+/- 3mm**
- Test results available upon request*

**Meets the U.S. Architectural & Transportation Barrier Compliance Board Slip-Resistance Surfaces Advisory Guidelines**

**SOLAR REFLECTIVE INDEX (SRI) TESTING DETAILS**

Product	Solar Reflectance	SRI
Notte	0.31	33 
Sabia	0.28	29 

**LEED INFORMATION**

**Materials & Resources: LEED V4:**

- Building Product Disclosure and Optimization
- Sourcing of Raw Materials - Sourcing of Raw Materials and Extraction • **1 point**
- Sourcing of Raw Materials - Leadership Extraction Practices • **1 point**
- Material Ingredient Reporting - Material Ingredient Reporting • **1 point**
- Material Ingredient Reporting - Material Ingredient Optimization • **1 point**
- Environmental Product Declaration • **1 point**

**TECHNICAL ADVANTAGES**

**ENDURACOLOR™**

Refined surface and long-lasting colour



Factory sealed for integral stain resistance

**ARTISTA™**

Boldly mottled colour finish

Random Bundle not recommended for vehicular  
Hex unit can handle vehicular loads

**PRODUCT DATA**

Stones & Bundling	Unit Thickness	SqFt Per				Per Bundle		Soldier LnFt Per			Sailor LnFt per			Units Per			Lbs Per	
		Bundle	Layer	Section	Stone	Layers	Sections	Unit	Section	Bundle	Unit	Section	Bundle	SqFt	Layer	Bundle	Layer	Bundle
<b>Pickering Manufacturing</b>																		
Random Bundle	2 3/8" (60mm)	94.20	10.47	-	-	9	-	-	-	-	0.99	-	79.45	0.76	-	72	287	2,584
Large Rectangle	2 3/8" (60mm)	-	-	-	2.09	-	-	-	-	-	1.75	-	31.80	0.48	-	18	-	-
Square	2 3/8" (60mm)	-	-	-	1.40	-	-	-	-	-	1.18	-	31.90	0.72	-	27	-	-
Small Rectangle	2 3/8" (60mm)	-	-	-	0.70	-	-	-	-	-	0.60	-	15.75	1.43	-	27	-	-
Hex Paver	2 3/4" (70mm)	73.92	9.24	-	0.42	8	-	-	-	-	-	-	2.60	24	192	306.25	2,450	

Notes: Sold in full bundles only on a refundable skid. **Minimum quantities apply on custom orders.** All measurements are nominal. **Important: A urethane rubber paver mat must be used to prevent scuffing.** For more information, samples or custom options, please contact your Unilock Territory Manager or call 1-800-UNILOCK.

**APPLICATIONS**



Pedestrian







Residential Vehicular (Hex only)



Commercial Vehicular (Hex only)

 \*Wall pairing suggestion- U-CARA™

RECOMMENDED SANDS				RECOMMENDED SEALER																							
 <p><b>Romex: Rompox™ ECO-Fine</b> Pedestrian Applications only Vehicular when laid on a Trass Bed</p> <ul style="list-style-type: none"> <li>  Ready mixed and easy to use</li> <li>  Resin film free</li> <li>  Resistant to ants, weeds, de-icing salts</li> <li>  Made from 98% natural, recycled or renewable raw materials</li> <li>  Pressure washer safe</li> <li>  Ideal for joint widths from 5mm (1/4")</li> </ul> <p><b>Coverage:</b></p> <table border="1"> <tr> <th>Colour</th> <th>5-6mm Joints</th> </tr> <tr> <td>Beige, Stone Grey, Anthracite 55 lb bag / 1 kg can</td> <td>125 sqft / 55 lb mix</td> </tr> </table>		Colour	5-6mm Joints	Beige, Stone Grey, Anthracite 55 lb bag / 1 kg can	125 sqft / 55 lb mix	 <p><b>Romex: Rompox™ D1</b> Heavy Duty Vehicular Applications</p> <ul style="list-style-type: none"> <li>  Light to medium vehicle rated</li> <li>  Increased pouring capacity that is self-compacting and water emulsifiable</li> <li>  Resistant to ants, weeds, de-icing salts</li> <li>  Pressure washer safe</li> <li>  Ideal for joint widths from 3mm (1/8")</li> <li>  Ideal for driveways, parking spaces and all vehicular loading applications up to 7.5 T</li> <li>  Three colours: Neutral, Stone Grey and Basalt</li> </ul> <p><b>Coverage:</b></p> <table border="1"> <tr> <th>Colour</th> <th>6mm Joints</th> </tr> <tr> <td>Neutral, Stone Grey, Basalt Two 1.5 L bottles to be mixed with one 55 lb bag of Romex approved sand</td> <td>25 sqft / 55 lb mix (based on 1,000 sqft)</td> </tr> </table>		Colour	6mm Joints	Neutral, Stone Grey, Basalt Two 1.5 L bottles to be mixed with one 55 lb bag of Romex approved sand	25 sqft / 55 lb mix (based on 1,000 sqft)	 <p><b>Alliance Gator G2 MAXX Sand</b></p> <ul style="list-style-type: none"> <li>  Rain safe after 15 minutes (24hr no rain if concrete overlay)</li> <li>  Sets above 32° F/ 0° C - may vary depending on weather, drainage, bedding materials and installation</li> <li>  Dust free and haze free</li> <li>  Requires only one watering</li> <li>  Four colours: Beige, Grey, Black and Ivory</li> </ul> <p><b>Coverage:</b></p> <table border="1"> <tr> <th>Colour</th> <th>Narrow Joints</th> <th>Wide Joints</th> </tr> <tr> <td>Beige, Ivory 50 lb bag</td> <td>65-85 sqft</td> <td>22-42 sqft</td> </tr> </table>		Colour	Narrow Joints	Wide Joints	Beige, Ivory 50 lb bag	65-85 sqft	22-42 sqft	 <p><b>Alliance Gator Natural Look Sealer</b></p> <ul style="list-style-type: none"> <li>  Water-based</li> <li>  Zero gloss finish</li> <li>  Multi purpose</li> <li>  Rain safe after 24 hours</li> </ul> <p><b>Coverage:</b></p> <table border="1"> <tr> <th>Size</th> <th>Area</th> </tr> <tr> <td>3.78 L / 1 U.S. gal.</td> <td>175 sqft</td> </tr> <tr> <td>18.9 L / 5.28 U.S. gal.</td> <td>875 sqft</td> </tr> </table>		Size	Area	3.78 L / 1 U.S. gal.	175 sqft	18.9 L / 5.28 U.S. gal.	875 sqft
Colour	5-6mm Joints																										
Beige, Stone Grey, Anthracite 55 lb bag / 1 kg can	125 sqft / 55 lb mix																										
Colour	6mm Joints																										
Neutral, Stone Grey, Basalt Two 1.5 L bottles to be mixed with one 55 lb bag of Romex approved sand	25 sqft / 55 lb mix (based on 1,000 sqft)																										
Colour	Narrow Joints	Wide Joints																									
Beige, Ivory 50 lb bag	65-85 sqft	22-42 sqft																									
Size	Area																										
3.78 L / 1 U.S. gal.	175 sqft																										
18.9 L / 5.28 U.S. gal.	875 sqft																										

\*Please refer to Sands & Sealers on pages 190-202 for more detailed information.

Unsure of bonded vs. unbonded product recommendations? Please contact your Unilock Territory Manager for more information.



# GRANITO™ MIX

**ENDURACOLOR™**Exclusive to **JNILOCK**  
**NEW FOR 2023**

NOTTE BLEND

## VISUAL APPEARANCE

Mottled, flecked; brushed and smooth finish. Sold in a 3 finish mixed bundle.

## FINISH

Boldly mottled colour finish.

## PRODUCT SPECIFICATIONS



7 x 14 x 3 1/8"  
180 x 360 x 80mm



7 x 14 x 3 1/8"  
180 x 360 x 80mm



7 x 14 x 3 1/8"  
180 x 360 x 80mm

3 FINISH MIXED BUNDLE

## EDGE DETAILS

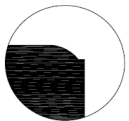

ROUNDED EDGE

## BUNDLE CONFIGURATION



\*Colour selection should be chosen from actual samples.

**TECHNICAL INFORMATION**

**ASTM C 936 Standard Specifications for Solid Concrete Interlocking Paving Units**

- Conforms to:
    - C140 for Absorption 5% avg - 7% max
    - Compressive Strength > 7,200 PSI avg.
    - C67 for Freeze-thaw Durability
    - C418 for Abrasion Durability
    - Dimensional Accuracy **+/- 3mm**
- Test results available upon request*

**Meets the U.S. Architectural & Transportation Barrier Compliance Board Slip-Resistance Surfaces Advisory Guidelines**

**LEED INFORMATION**

**Materials & Resources: LEED V4:**

- Building Product Disclosure and Optimization
- Sourcing of Raw Materials - Sourcing of Raw Materials and Extraction • **1 point**
- Sourcing of Raw Materials - Leadership Extraction Practices • **1 point**
- Material Ingredient Reporting - Material Ingredient Reporting • **1 point**
- Material Ingredient Reporting - Material Ingredient Optimization • **1 point**
- Environmental Product Declaration • **1 point**

**TECHNICAL ADVANTAGES**

**ENDURACOLOR™**

Refined surface and long-lasting colour



Factory sealed for integral stain resistance

**ARTISTA™**

Boldly mottled colour finish

Random Bundle not recommended for vehicular

**PRODUCT DATA**

Stones & Bundling	Unit		SqFt Per				Per Bundle		Soldier LnFt Per			Sailor LnFt per			Units Per			Lbs Per	
	Thickness	Bundle	Layer	Section	Stone	Layers	Sections	Unit	Section	Bundle	Unit	Layer	Bundle	SqFt	Layer	Bundle	Layer	Bundle	
<b>Pickering Manufacturing</b>																			
7 x 14	3 1/8" (80mm)	81.60	11.66	-	0.78	7	-	0.78	-	65.45	1.25	18.70	130.91	1.29	-	105	426.57	2,985.98	

Notes: Sold in full bundles only on a refundable skid. **Minimum quantities apply on custom orders.** All measurements are nominal. **Important: A urethanerubber paver mat must be used to prevent scuffing.** For more information, samples or custom options, please contact your Unilock Territory Manager or call 1-800-UNILOCK.

**APPLICATIONS**



\*Wall pairing suggestion- U-CARA\*

RECOMMENDED SANDS			RECOMMENDED SEALER																								
 <b>Romex: Rompox® Fugensand</b> Pedestrian, Vehicular and Heavy Duty Vehicular Applications   Manufactured from natural, raw materials   Quick application   Self-repairing properties   Suitable for all load classes   No cement haze/residue due to natural polymer binder   Three colours: Natural, Stone Grey and Basalt <b>Coverage:</b> <table border="1"> <tr> <th>Colour</th> <th>5-6mm Joints</th> </tr> <tr> <td>Neutral, Stone Grey, Basalt <i>1 L / 5 gal</i></td> <td>50-150 sqft / 55 lb bag</td> </tr> </table>	Colour	5-6mm Joints	Neutral, Stone Grey, Basalt <i>1 L / 5 gal</i>	50-150 sqft / 55 lb bag	+	 <b>Romex: Rompox® D7000 Joint Strengthener &amp; Surface Sealer</b> Pedestrian, Vehicular and Heavy Duty Vehicular Applications   All-in-one strengthener & sealer   Eco-Friendly   Protects against dirt, oil, corrosion from climate exposure, de-icing salts   Protects against weed growth and wash outs <b>Coverage:</b> <table border="1"> <tr> <th>Colour</th> <th>3-4mm Joints</th> </tr> <tr> <td>Neutral, Stone Grey, Basalt <i>55lb. bag / 1 kg can</i></td> <td>50-150 sqft/ 55 lb mix</td> </tr> </table>	Colour	3-4mm Joints	Neutral, Stone Grey, Basalt <i>55lb. bag / 1 kg can</i>	50-150 sqft/ 55 lb mix	 <b>Alliance Gator G2 MAXX Sand</b>   Rain safe after 15 minutes (24hr no rain if concrete overlay)   Sets above 32° F/ 0° C - may vary depending on weather, drainage, bedding materials and installation   Dust free and haze free   Requires only one watering   Four colours: Beige, Grey, Black and Ivory <b>Coverage:</b> <table border="1"> <tr> <th>Colour</th> <th>Narrow Joints</th> <th>Wide Joints</th> </tr> <tr> <td>Beige, Grey, Ivory <i>50 lb bag</i></td> <td>65-85 sqft</td> <td>22-42 sqft</td> </tr> <tr> <td>Black <i>50 lb bag</i></td> <td>58-76 sqft</td> <td>20-38 sqft</td> </tr> </table>	Colour	Narrow Joints	Wide Joints	Beige, Grey, Ivory <i>50 lb bag</i>	65-85 sqft	22-42 sqft	Black <i>50 lb bag</i>	58-76 sqft	20-38 sqft	 <b>Alliance Gator Natural Look Sealer</b>   Water-based   Zero gloss finish   Multi purpose   Rain safe after 24 hours <b>Coverage:</b> <table border="1"> <tr> <th>Size</th> <th>Area</th> </tr> <tr> <td>3.78 L / 1 U.S. gal.</td> <td>175 sqft</td> </tr> <tr> <td>18.9 L / 5.28 U.S. gal.</td> <td>875 sqft</td> </tr> </table>	Size	Area	3.78 L / 1 U.S. gal.	175 sqft	18.9 L / 5.28 U.S. gal.	875 sqft
Colour	5-6mm Joints																										
Neutral, Stone Grey, Basalt <i>1 L / 5 gal</i>	50-150 sqft / 55 lb bag																										
Colour	3-4mm Joints																										
Neutral, Stone Grey, Basalt <i>55lb. bag / 1 kg can</i>	50-150 sqft/ 55 lb mix																										
Colour	Narrow Joints	Wide Joints																									
Beige, Grey, Ivory <i>50 lb bag</i>	65-85 sqft	22-42 sqft																									
Black <i>50 lb bag</i>	58-76 sqft	20-38 sqft																									
Size	Area																										
3.78 L / 1 U.S. gal.	175 sqft																										
18.9 L / 5.28 U.S. gal.	875 sqft																										

\*Please refer to Sands & Sealers on pages 190-202 for more detailed information.

Unsure of bonded vs. unbonded product recommendations? Please contact your Unilock Territory Manager for more information.

# HOLLANDSTONE™ / DOUBLE HOLLAND



HOLLANDSTONE DOUBLE HOLLAND

## CLASSIC

*\*80mm - Special Order only. Minimum qtys apply\**



DARK CHARCOAL



GRANITE



NATURAL

32  
SRI



SIERRA

*Hollandstone only*

## VISUAL APPEARANCE

With its wide range of colours, Hollandstone™ is a favourite for many because of the design flexibility it provides. Available in one size, this paver can be laid in various patterns.

## FINISH

Smooth, classic appearance.

## PRODUCT SPECIFICATIONS



**HOLLANDSTONE**  
4 x 8 x 2<sup>3</sup>/<sub>8</sub>"  
100 x 200 x 60 mm



**DOUBLE HOLLAND**  
8 x 8 x 2<sup>3</sup>/<sub>8</sub>"  
200 x 200 x 60mm

## EDGE DETAILS



CHAMFERED

## LAYING PATTERNS

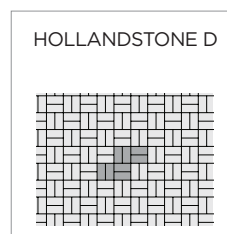
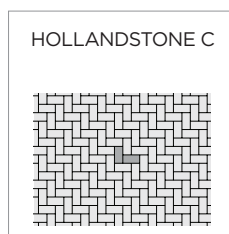
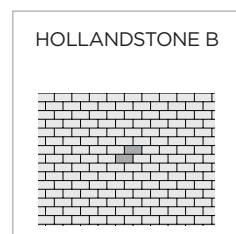

\*Colour selection should be chosen from actual samples.

**TECHNICAL INFORMATION**

**ASTM C 936 Standard Specifications for Solid Concrete Interlocking Paving Units**

Conforms to:

- C140 for Absorption 5% avg - 7% max
- Compressive Strength > 7,200 PSI avg.
- C67 for Freeze-thaw Durability
- C418 for Abrasion Durability
- Dimensional Accuracy +/- 3mm

Test results available upon request

**Meets the U.S. Architectural & Transportation Barrier Compliance Board Slip-Resistance Surfaces Advisory Guidelines**

**SOLAR REFLECTIVE INDEX (SRI) TESTING DETAILS**

Product	Solar Reflectance	SRI
Natural	0.30	32 

**LEED INFORMATION**

**Materials & Resources: LEED V4:**

- Building Product Disclosure and Optimization
- Sourcing of Raw Materials - Sourcing of Raw Materials and Extraction • 1 point
- Sourcing of Raw Materials - Leadership Extraction Practices • 1 point
- Material Ingredient Reporting - Material Ingredient Reporting • 1 point
- Material Ingredient Reporting - Material Ingredient Optimization • 1 point
- Environmental Product Declaration • 1 point

**TECHNICAL ADVANTAGES**

**CLASSIC**

Budget-friendly. Utilizes a traditional product mix of large and small aggregates that's consistent from top to bottom with colour mixed throughout

**DRIVE FRIENDLY**

80mm pavers can handle vehicular loads  
Ask about our base stabilization system

**PRODUCT DATA**

Stones & Bundling	Thickness	Bundle	Layer	Section	Stone	Layers	Sections	Unit	Section	Bundle	Unit	Section	Bundle	SqFt	Section	Bundle	Layer	Section	Bundle
<b>Ayr Manufacturing</b>																			
Hollandstone	2 3/8" (60mm)	109.26	10.93	21.85	0.22	10	5	0.33	32.80	164.00	0.66	65.60	328.10	4.58	100	500	300	600	2,999
	3 1/2" (80mm)	87.41	10.93	17.48	0.22	8	5	0.33	26.20	131.20	0.66	52.50	262.50	4.58	80	400	400	640	3,199
Double Holland	2 3/8" (60mm)	108.72	10.87	21.74	0.44	10	5	0.66	32.80	164.00	0.66	32.80	164.00	2.30	50	250	298	597	2,984
	3 1/2" (80mm)	86.98	10.87	17.40	0.44	8	5	0.66	26.20	131.20	0.66	26.20	131.20	2.30	40	200	398	637	3,183

Notes: Hollandstone™ is available in all listed colours. Double Holland is available in Dark Charcoal, Granite, Natural. Hollandstone™ and Double Holland are dimensionally compatible. All measurements are nominal. **\*80mm product is special order.** For more information, samples or custom options, please contact your Unilock Territory Manager or call 1-800-UNILOCK.

**APPLICATIONS**



Pedestrian



Residential Vehicular  
(Hollandstone & Double Holland 80mm only)



Commercial Vehicular  
(Hollandstone & Double Holland 80mm only)



Roof Decks  
(Double Holland only)



Borders and Accents

 \*Wall pairing suggestion- Lineo™ Dimensional Stone or U-CARA® Wall

**RECOMMENDED SANDS**

**RECOMMENDED SEALER**



**Romex: Rompox® Fugensand**  
Pedestrian, Vehicular and Heavy Duty Vehicular Applications  
| Manufactured from natural, raw materials  
| Quick application  
| Self-repairing properties  
| Suitable for all load classes  
| No cement haze/residue due to natural polymer binder  
| Three colours: Natural, Stone Grey and Basalt

**Coverage:**

Colour	5-6mm Joints
Neutral, Stone Grey, Basalt 1 L / 5 gal	50-150 sqft / 55 lb bag

**Romex: Rompox® D7000 Joint Strengthening & Surface Sealer**  
Pedestrian, Vehicular and Heavy Duty Vehicular Applications  
| All-in-one strengthener & sealer  
| Eco-Friendly  
| Protects against dirt, oil, corrosion from climate exposure, de-icing salts  
| Protects against weed growth and wash outs

**Coverage:**

Colour	3-4mm Joints
Neutral, Stone Grey, Basalt 55lb. bag / 1 kg can	50-150 sqft / 55 lb mix

**Alliance Gator G2 Super Sand**  
| Rain safe after 1 hour (no concrete overlays)  
| Sets above 32° F/ 0° C - may vary depending on weather, drainage, bedding materials and installation  
| Can be used for joints up to a max of 2"  
| Dust free and haze free  
| Requires only one watering  
| Two colours: Beige, Slate Grey

**Coverage:**

Colour	Narrow Joints	Wide Joints
Beige, Slate Grey 50 lb bag	65-85 sqft	22-42 sqft

**Alliance Gator Natural Look Sealer**  
| Water-based  
| Zero gloss finish  
| Multi purpose  
| Rain safe after 24 hours

**Coverage:**

Size	Area
3.78 L / 1 U.S. gal.	175 sqft
18.9 L / 5.28 U.S. gal.	875 sqft

\*Please refer to Sands & Sealers on pages 190-202 for more detailed information.

Unsured of bonded vs. unbonded product recommendations? Please contact your Unilock Territory Manager for more information.



# IL CAMPO<sup>®</sup>

## ENDURACOLOR™

Exclusive to **UNILOCK**

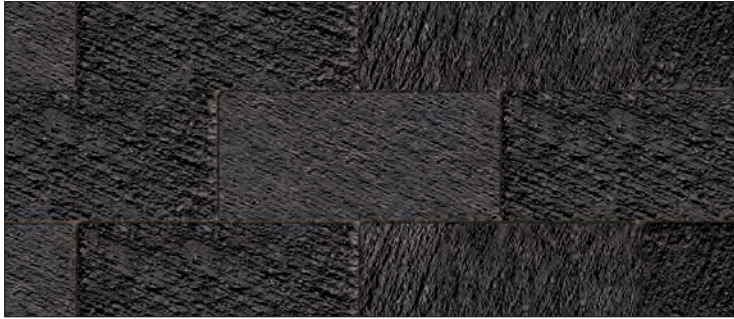

DARK CHARCOAL



GRANITE BLEND



LIGHT GREY



SANDSTONE

### VISUAL APPEARANCE

The detailed look that is striking and inviting at the same time, and unlike any other paver you can buy.

### FINISH

Created with technology that is exclusive to Unilock, the etched lines on the surface of Il Campo<sup>®</sup> make it a richly detailed, striking choice for virtually any application.

### PRODUCT SPECIFICATIONS



4 x 8 x 2<sup>3</sup>/<sub>4</sub>"  
100 x 200 x 70mm  
*Dark Charcoal only*



7 x 14 x 3<sup>1</sup>/<sub>8</sub>"  
180 x 360 x 80mm  
*Dark Charcoal only*



8 x 16 x 2<sup>3</sup>/<sub>4</sub>"  
200 x 400 x 70mm  
*All Colours*

### EDGE DETAILS



WAVED EDGE

### LAYING PATTERNS

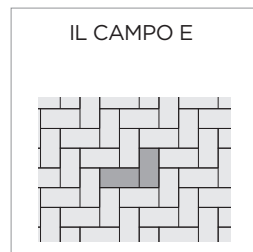

IL CAMPO E  
100% 8x16

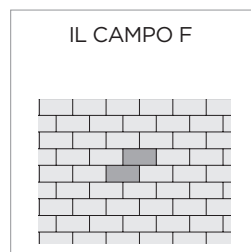

IL CAMPO F  
100% 4x8

\*Colour selection should be chosen from actual samples.



**TECHNICAL INFORMATION**

**ASTM C 936 Standard Specifications for Solid Concrete Interlocking Paving Units**

- Conforms to:
- C140 for Absorption 5% avg - 7% max
  - Compressive Strength > 7,200 PSI avg.
  - C67 for Freeze-thaw Durability
  - C418 for Abrasion Durability
  - Dimensional Accuracy **+/- 3mm**
- Test results available upon request*

**Meets the U.S. Architectural & Transportation Barrier Compliance Board Slip-Resistance Surfaces Advisory Guidelines**

**SOLAR REFLECTIVE INDEX (SRI) TESTING DETAILS**

Product	Solar Reflectance	SRI
Light Grey	0.22	32 
Sandstone	0.2	19 

**TECHNICAL ADVANTAGES**

**ENDURACOLOR™**

Refined surface and long-lasting colour

**DRIVE FRIENDLY**

Can handle vehicular loads  
*Ask about our base stabilization system*

**BRUSHED FINISH**

Graphically interesting etched lines

**LEED INFORMATION**

**Materials & Resources: LEED V4:**

- Building Product Disclosure and Optimization
- Sourcing of Raw Materials - Sourcing of Raw Materials and Extraction • **1 point**
- Sourcing of Raw Materials - Leadership Extraction Practices • **1 point**
- Material Ingredient Reporting - Material Ingredient Reporting • **1 point**
- Material Ingredient Reporting - Material Ingredient Optimization • **1 point**
- Environmental Product Declaration • **1 point**

**PRODUCT DATA**

Stones & Bundling	Unit Thickness	SqFt Per				Per Bundle		Soldier LnFt Per			Sailor LnFt per			Units Per			Lbs Per		
		Bundle	Layer	Section	Stone	Layers	Sections	Unit	Layer	Bundle	Unit	Layer	Bundle	SqFt	Section	Bundle	Layer	Section	Bundle
<b>80mm - Georgetown Manufacturing; 70mm Pickering Manufacturing</b>																			
4" x 8"	2¾" (70mm)	94.40	11.80	-	0.22	8	-	0.33	-	141.80	0.67	-	283.60	4.57	-	432	377	-	3,021
7" x 14"	3 1/8" (80mm)	73.24	10.46	-	0.70	7	-	0.85	-	62.01	1.69	-	124.02	1.43	-	105	382.85	-	2,679.98
8" x 16"	2¾" (70mm)	82.67	10.33	-	0.86	8	-	0.66	-	62.99	1.33	-	125.99	1.16	-	96	343.29	-	2,746.30

Notes: Il Campo is sold in full bundles only on a refundable skid. All measurements are nominal. **Important: A urethane rubber mat must be used to prevent scuffing.** For more information, samples or custom options, please contact your Unilock Territory Manager or call 1-800-UNILOCK.

**APPLICATIONS**



Pedestrian



Residential Vehicular



Commercial Vehicular



Borders and Accents



Roof Decks



\*Wall pairing suggestion- U-CARA® Wall or Lineo™ Dimensional Stone

**RECOMMENDED SANDS**

**RECOMMENDED SEALER**



**Romex: Rompox® Fugensand**  
Suitable for Pedestrian, Vehicular and Heavy Duty Vehicular Applications

- | Manufactured from natural, raw materials
- | Quick application
- | Self-repairing properties
- | Suitable for all load classes
- | No cement haze/residue due to natural polymer binder
- | Three colours: Natural, Stone Grey and Basalt

Coverage:

Colour	3mm Joints
Neutral, Stone Grey, Basalt <i>1 L / 5 gal</i>	110 sqft / 55 lb bag 750 sqft / 5 gal drum

**Romex: Rompox® D7000 Joint Strengtheners & Surface Sealer**  
Pedestrian, Vehicular and Heavy Duty Vehicular Applications

- | All-in-one strengthener & sealer
- | Eco-Friendly
- | Protects against dirt, oil, corrosion from climate exposure, de-icing salts
- | Protects against weed growth and wash outs

Coverage:

Colour	3mm Joints
Neutral, Stone Grey, Basalt <i>55 lb bag / 1 kg can</i>	110 sqft / 55 lb bag 750 sqft / 5 gal drum

**Alliance Gator G2 MAXX Sand**

- | Rain safe after 15 minutes (24hr no rain if concrete overlay)
- | Sets above 32° F/ 0° C - may vary depending on weather, drainage, bedding materials and installation
- | Dust free and haze free
- | Requires only one watering
- | Four colours: Beige, Grey, Black and Ivory

Coverage:

Colour	Narrow Joints	Wide Joints
Beige, Grey, Ivory <i>50 lb bag</i>	65-85 sqft	22-42 sqft
Black <i>50 lb bag</i>	58-76 sqft	20-38 sqft

**Alliance Gator Natural Look Sealer**

- | Water-based
- | Zero gloss finish
- | Multi purpose
- | Rain safe after 24 hours

Coverage:

Size	Area
3.78 L / 1 U.S. gal.	175 sqft
18.9 L / 5.28 U.S. gal.	875 sqft

\*Please refer to Sands & Sealers on pages 190-202 for more detailed information.

Unsure of bonded vs. unbonded product recommendations? Please contact your Unilock Territory Manager for more information.

# LOAD LOCK

*\*Special Order only. Minimum qtys apply\**



## VISUAL APPEARANCE

Dependent upon the finish - the visual appearance will be different - see visual appearances for the below listed products/finishes for more details.

## AVAILABLE FINISHES

EnduraColor™ Smooth, Il Campo®, Revela™, Series™ and Umbriano®.

## PRODUCT SPECIFICATIONS



4 x 12 x 4"  
100 x 300 x 100mm



12 x 12 x 4"  
300 x 300 x 100mm



## LOAD LOCK

For heavy traffic volumes and high loads.

Load Lock pavers are a patented fully-interlocking system with integrated protection against shifting. The patented jointing technology concentrates on **surfaces with heavy traffic volumes and high loads.**

The benefits:

- no displacement or deformation of paving elements
- no tilting or jamming of the paving edges even under the highest loads



## EDGE DETAILS



ROUNDED EDGE

\*Colour selection should be chosen from actual samples.



**TECHNICAL INFORMATION**

**ASTM C 936 Standard Specifications for Solid Concrete Interlocking Paving Units**

Conforms to:

- C140 for Absorption 5% avg - 7% max
- Compressive Strength > 7,200 PSI avg.
- C67 for Freeze-thaw Durability
- C418 for Abrasion Durability
- Dimensional Accuracy +/- 3mm

*Test results available upon request*

**Meets the U.S. Architectural & Transportation Barrier Compliance Board Slip-Resistance Surfaces Advisory Guidelines**

**LEED INFORMATION**

**Materials & Resources: LEED V4:**

- Building Product Disclosure and Optimization
- Sourcing of Raw Materials - Sourcing of Raw Materials and Extraction • **1 point**
- Sourcing of Raw Materials - Leadership Extraction Practices • **1 point**
- Material Ingredient Reporting - Material Ingredient Reporting • **1 point**
- Material Ingredient Reporting - Material Ingredient Optimization • **1 point**
- Environmental Product Declaration • **1 point**

**TECHNICAL ADVANTAGES**

**ENDURACOLOR™**

Refined surface and long-lasting colour

**DRIVE FRIENDLY**

Can handle vehicular loads

*Ask about our base stabilization system*

**PRODUCT DATA**

Stones & Bundling	Unit Thickness	SqFt Per				Per Bundle		Soldier LnFt Per			Sailor LnFt per			Units Per			Lbs Per			
		Bundle	Layer	Section	Stone	Layers	Sections	Unit	Layer	Bundle	Unit	Section	Bundle	SqFt	Section	Bundle	Layer	Section	Bundle	
<b>Pickering Manufacturing</b>																				
4" x 12"	4" (100mm)	-	-	-	-	-	-	-	-	-	-	-	-	-	-	-	-	-	-	-
12" x 12"	4" (100mm)	58.2	11.64		0.97	5		0.98	11.81	59.05				1.03		60	531.74	-	2,658.7	

Notes: Sold in full bundles only on a refundable skid. All measurements are nominal. **Important: A urethane rubber paver mat must be used to prevent scuffing.** For more information, samples or custom options, please contact your Unilock Territory Manager or call 1-800-UNILOCK.

**APPLICATIONS**



Permeable (Heavy Duty)



Pedestrian



Residential Vehicular



Commercial Vehicular



Borders and Accents

**RECOMMENDED SANDS**



**Romex: Rompox® Pure Patio**  
Pedestrian Applications only

- | Resin film-free
- | Highly water permeable
- | Resistant to ants, weeds, de-icing salts
- | Pressure washer safe
- | Ideal for joint widths from 5mm (1/4")
- | Ideal for Residential patios and walkways
- | Three colours: Neutral, Stone Grey and Basalt



**Romex: Rompox® Drain**  
Vehicular Applications

- | Resin film-free
- | Highly water permeable
- | Self-compacting and water emulsifiable
- | Resistant to ants, weeds, de-icing salts
- | Pressure washer safe
- | Ideal for joint widths from 3mm (1/4")
- | Ideal for driveways, parking spaces and all vehicular loading applications up to 3.5 T
- | Three colours: Neutral, Stone Grey and Basalt



**Romex: Rompox® D1**  
Heavy Duty Vehicular Applications

- | Light to medium vehicle rated
- | Increased pouring capacity that is self-compacting and water emulsifiable
- | Resistant to ants, weeds, de-icing salts
- | Pressure washer safe
- | Ideal for joint widths from 3mm (1/8")
- | Ideal for driveways, parking spaces and all vehicular loading applications up to 7.5 T
- | Three colours: Neutral, Stone Grey and Basalt

**Coverage:**

Colour	7mm Joints
Neutral, Stone Grey, Basalt <i>55 lb bag / 1 kg can</i>	20 sqft / 55 lb mix <i>(based on 1,000 sqft)</i>

**Coverage:**

Colour	7mm Joints
Neutral, Stone Grey, Basalt <i>Two 1 L bottles to be mixed with one 55 lb bag of Romex approved sand</i>	20 sqft / 55 lb mix <i>(based on 1,000 sqft)</i>

**Coverage:**

Colour	7mm Joints
Neutral, Stone Grey, Basalt <i>Two 1.5 L bottles to be mixed with one 55 lb bag of Romex approved sand</i>	20 sqft / 55 lb mix <i>(based on 1,000 sqft)</i>

\*Please refer to Sands & Sealers on pages 190-202 for more detailed information.

Unsure of bonded vs. unbonded product recommendations? Please contact your Unilock Territory Manager for more information.

# MATTONI™

Exclusive to **UNILOCK**

## ENDURACOLOR™

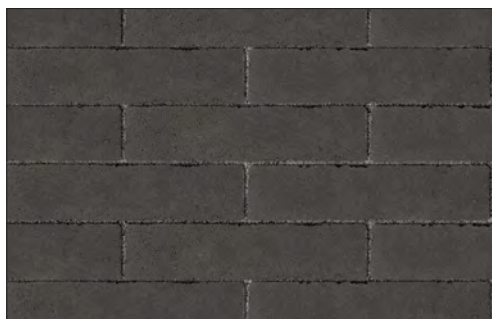

DARK CHARCOAL



GRANITE BLEND



SABLE BLEND

31  
SRINOTTE (GRANITO BRUSHED FINISH) **NEW**SCURO (GRANITO BRUSHED FINISH) **NEW**

### VISUAL APPEARANCE

Mattoni™ reinterprets classic slender Roman brick. This format is ideal for curved garden paths, authentic country gardens and classic herringbone patterns.

### FINISH

The surface is antiqued for a distressed, timeworn appearance. The refined surface and long-lasting colour benefits of EnduraColor™ are available in several colours and finishes.

### PRODUCT SPECIFICATIONS



2⅜ x 9⅝ x 2¾"  
60 x 240 x 70mm

### EDGE DETAILS



WAVED EDGE

### LAYING PATTERNS

MATTONI A

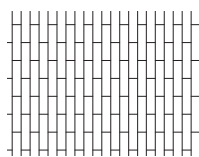

MATTONI C

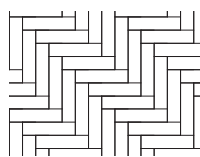

MATTONI D

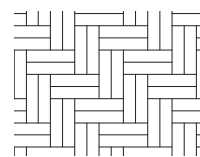

\*Colour selection should be chosen from actual samples.

**TECHNICAL INFORMATION**

**ASTM C 936 Standard Specifications for Solid Concrete Interlocking Paving Units**

Conforms to:

- C140 for Absorption 5% avg - 7% max
- Compressive Strength > 7,200 PSI avg.
- C67 for Freeze-thaw Durability
- C418 for Abrasion Durability
- Dimensional Accuracy **+/- 3mm**

*Test results available upon request*

**Meets the U.S. Architectural & Transportation Barrier Compliance Board Slip-Resistance Surfaces Advisory Guidelines**

**SOLAR REFLECTIVE INDEX (SRI) TESTING DETAILS**

Product	Solar Reflectance	SRI
Sable Blend	0.29	31 

**LEED INFORMATION**

**Materials & Resources: LEED V4:**

- Building Product Disclosure and Optimization
- Sourcing of Raw Materials - Sourcing of Raw Materials and Extraction • **1 point**
- Sourcing of Raw Materials - Leadership Extraction Practices • **1 point**
- Material Ingredient Reporting - Material Ingredient Reporting • **1 point**
- Material Ingredient Reporting - Material Ingredient Optimization • **1 point**
- Environmental Product Declaration • **1 point**

**TECHNICAL ADVANTAGES**

**ENDURACOLOR™**

Refined surface and long-lasting colour



Factory sealed for integral stain resistance

**ANTIQUED FINISH**

Distressed, timeworn finish

**DRIVE FRIENDLY**

Can handle vehicular loads

*Ask about our base stabilization system*

**PRODUCT DATA**

Stones & Bundling	Unit		SqFt Per				Per Bundle		Soldier LnFt Per		Sailor LnFt per		Units Per			Lbs Per			
	Thickness	Bundle	Layer	Section	Stone	Layers	Sections	Unit	Section	Bundle	Unit	Section	Bundle	SqFt	Section	Bundle	Layer	Section	Bundle
<b>Pickering Manufacturing</b>																			
2.25" x 9.5"	2 3/4" (70mm)	89.28	11.16	-	0.16	8	-	0.20	-	113.4	0.79	-	453.50	6.45	-	576	357	-	2,859

Notes: Sold in full bundles only on a refundable skid. All measurements are nominal. **Important: A urethane rubber paver mat must be used to prevent scuffing.** For more information, samples or custom options, please contact your Unilock Territory Manager or call 1-800-UNILOCK.

**APPLICATIONS**



Pedestrian



Residential Vehicular



Borders and Accents



\*Wall pairing suggestion- U-CARA® Wall

**RECOMMENDED SANDS**

**RECOMMENDED SEALER**



+



**Romex: Rompox® Fugensand**  
 Pedestrian, Vehicular and Heavy Duty Vehicular Applications  
 | Manufactured from natural, raw materials  
 | Quick application  
 | Self-repairing properties  
 | Suitable for all load classes  
 | No cement haze/residue due to natural polymer binder  
 | Three colours: Natural, Stone Grey and Basalt

**Romex: Rompox® D7000 Joint Strengthener & Surface Sealer**  
 Pedestrian, Vehicular and Heavy Duty Vehicular Applications  
 | All-in-one strengthener & sealer  
 | Eco-Friendly  
 | Protects against dirt, oil, corrosion from climate exposure, de-icing salts  
 | Protects against weed growth and wash outs

**Alliance Gator G2 MAXX Sand**  
 | Rain safe after 15 minutes (24hr no rain if concrete overlay)  
 | Sets above 32° F/ 0° C - may vary depending on weather, drainage, bedding materials and installation  
 | Dust free and haze free  
 | Requires only one watering  
 | Four colours: Beige, Grey, Black and Ivory

**Alliance Gator Natural Look Sealer**  
 | Water-based  
 | Zero gloss finish  
 | Multi purpose  
 | Rain safe after 24 hours

**Coverage:**

Colour	3mm Joints
Neutral, Stone Grey, Basalt <i>1 L / 5 gal</i>	110 sqft / 55 lb bag / 750 sqft/ 5 gal drum

**Coverage:**

Colour	3mm Joints
Neutral, Stone Grey, Basalt <i>55 lb bag / 1 kg can</i>	110 sqft / 55 lb bag / 750 sqft/ 5 gal drum

**Coverage:**

Colour	Narrow Joints	Wide Joints
Beige, Grey, Ivory <i>50 lb bag</i>	65-85 sqft	22-42 sqft
Black <i>50 lb bag</i>	58-76 sqft	20-38 sqft

**Coverage:**

Size	Area
3.78 L / 1 U.S. gal.	175 sqft
18.9 L / 5.28 U.S. gal.	875 sqft

\*Please refer to Sands & Sealers on pages 190-202 for more detailed information.

Unsured of bonded vs. unbonded product recommendations? Please contact your Unilock Territory Manager for more information.

# NORDIC COBBLE™

NEW FOR 2023

ENDURACOLOR™



GLACIER



MOUNTAIN MIST



BLACK GRANITE



## VISUAL APPEARANCE

Modelled after traditional hand-cut granite cobbles, Nordic Cobble is a stylish option for striking borders, grid patterns and circular designs. Randomized cobble 'faces' offer a natural look that works equally well whether it's used in combination with rustic pavers or juxtaposed with sleek, contemporary slabs. Nordic Cobble can be installed either traditionally or on a permeable base to allow water to flow through.

## FINISH

The aggregate surface is pressed into the stone surface simultaneously with the body of the stone in a single process and not in layers. The resulting surface becomes an integral part of the paver itself, giving you long-term wear and structural performance.

## PRODUCT SPECIFICATIONS



### TRAPEZOID

3 5/8 x 3 3/4 x 2 3/8"  
90 x 94 x 60 mm

## EDGE DETAILS



ZERO BEVEL EDGE

## BUNDLE CONFIGURATION

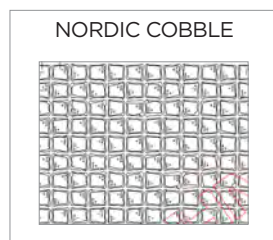

**TECHNICAL INFORMATION**

**ASTM C 936 Standard Specifications for Solid Concrete Interlocking Paving Units**

- Conforms to:
    - C140 for Absorption 5% avg - 7% max
    - Compressive Strength > 7,200 PSI avg.
    - C67 for Freeze-thaw Durability
    - C418 for Abrasion Durability
    - Dimensional Accuracy **+/- 3mm**
- Test results available upon request*

**Meets the U.S. Architectural & Transportation Barrier Compliance Board Slip-Resistance Surfaces Advisory Guidelines**

**SOLAR REFLECTIVE INDEX (SRI) TESTING DETAILS**

Product	Solar Reflectance	SRI
Glacier	0.41	46 

**TECHNICAL ADVANTAGES**

**ENDURACOLOR™**

Refined surface and long-lasting colour

 **PERMEABLE**

Can be installed to allow water to flow through

**LEED INFORMATION**

**Materials & Resources: LEED V4:**

- Building Product Disclosure and Optimization
- Sourcing of Raw Materials - Sourcing of Raw Materials and Extraction • **1 point**
- Sourcing of Raw Materials - Leadership Extraction Practices • **1 point**
- Material Ingredient Reporting - Material Ingredient Reporting • **1 point**
- Material Ingredient Reporting - Material Ingredient Optimization • **1 point**
- Environmental Product Declaration • **1 point**

**PRODUCT DATA**

Stones & Bundling	Unit	SqFt Per			Per Bundle		Soldier LnFt Per			Sailor LnFt per			Units Per			Lbs Per	
	Thickness	Bundle	Layer	Stone	Layers	Sections	Unit	Layer	Bundle	Unit	Section	Bundle	SqFt	Section	Bundle	Layer	Bundle
<b>Georgetown Manufacturing</b>																	
Trapezoid	2 3/8" (60mm)	58.95	9.825	0.05	6	-	0.1542	33.30	266.46	-	-	-	21.98	-	1,296	269.65	2,157.16

Notes: Sold in full bundles only on a refundable skid. All measurements are nominal. **Important: A urethane rubber paver mat must be used to prevent scuffing.** For more information, samples or custom options, please contact your Unilock Territory Manager or call 1-800-UNILOCK.

**APPLICATIONS**



Pedestrian



Residential Vehicular



Commercial Vehicular



Permeable



Borders and Accents



\*Wall pairing suggestion- U-CARA® Wall or Lineo™ Dimensional Stone

**RECOMMENDED SANDS**

**RECOMMENDED SEALER**



**Romex: Rompox® ECO-Fine**  
Pedestrian Applications only  
Vehicular when laid on a Trass Bed

- | Ready mixed and easy to use
- | Resin film free
- | Resistant to ants, weeds, de-icing salts
- | Made from 98% natural, recycled or renewable raw materials
- | Pressure washer safe
- | Ideal for joint widths from 5 mm (1/4")

**Coverage:**

Colour	5-6mm Joints
Beige, Stone Grey, Anthracite 55 lb bag / 1 kg can	125 sqft / 55 lb mix



 **Romex: Rompox® Flex Joint**  
Pedestrian, Vehicular and Heavy Duty  
Vehicular Applications

- | Viscous elastic jointing mortar (sand and rubber)
- | Suitable for vehicular rated and unbonded surfaces
- | Water permeable, self compacting and water emulsifiable during installation
- | Medium to heavy traffic up to 25 T
- | Three colours: Neutral, Stone Grey and Basalt

**Coverage:**

Colour	12mm Joints
Neutral, Stone Grey, Basalt 25 kg bucket / 55 lb bucket	27 sqft / 55 lb bucket (based on 1,000 sqft)



**Alliance Gator G2 MAXX Sand**

- | Rain safe after 15 minutes (24hr no rain if concrete overlay)
- | Sets above 32° F/ 0° C - may vary depending on weather, drainage, bedding materials and installation
- | Dust free and haze free
- | Requires only one watering
- | Four colours: Beige, Grey, Black and Ivory

**Coverage:**

Colour	Narrow Joints	Wide Joints
Beige, Grey, Ivory 50 lb bag	65-85 sqft	22-42 sqft
Black 50 lb bag	58-76 sqft	20-38 sqft



**Alliance Gator Seal Satin Look**

- | Solvent-based
- | Low gloss finish
- | Vibrant colour enhancer
- | Rain safe after 90 minutes
- Helps resist corrosion from de-icing salt, ultra-violet rays effects, motor oils and grease stains

**Coverage:**

Size	Area
3.78 L / 1 U.S. gal.	175 sqft

\*Please refer to Sands & Sealers on pages 190-202 for more detailed information.

Unsure of bonded vs. unbonded product recommendations? Please contact your Unilock Territory Manager for more information.

# NORTHSHORE™

## ENDURACOLOR™



FOSSIL

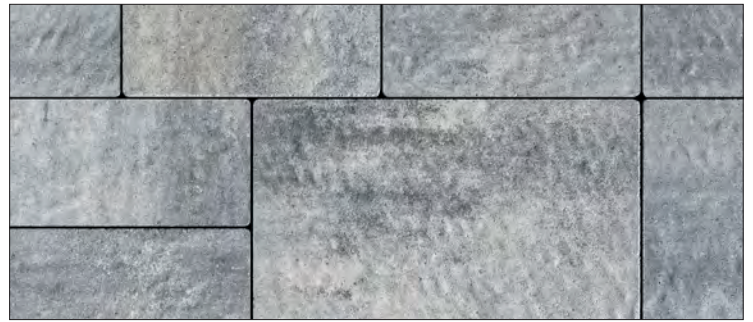

GRANITE MIST



MIDNIGHT CHARCOAL  
*6 x 12 only*

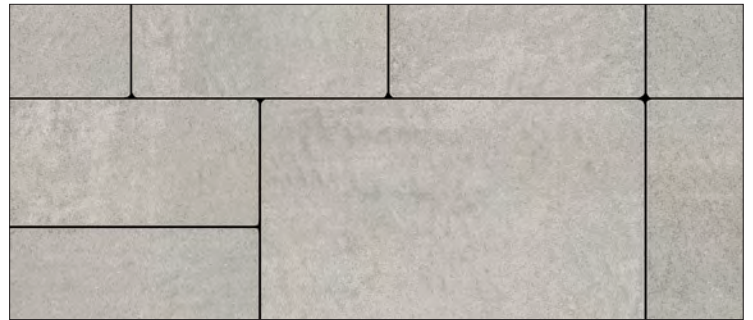

STERLING **NEW**

### VISUAL APPEARANCE

Gentle surface clefts and waved edges.

### FINISH

NEW Comfort Step finish - ultra smooth surface texture, sealed with EasyClean™ to provide integral surface protection from stains and the refined surface and long-lasting colour benefits of EnduraColor™.

### PRODUCT SPECIFICATIONS



**LARGE RECTANGLE**  
12 x 18 x 2¾"  
300 x 457 x 70mm



**SQUARE**  
12 x 12 x 2¾"  
300 x 300 x 70mm



**SMALL RECTANGLE**  
6 x 12 x 2¾"  
150 x 300 x 70mm



**SMALL RECTANGLE**  
6 x 12 x 2¾"  
150 x 300 x 70mm  
*Midnight Charcoal only*

3 UNIT RANDOM BUNDLE

### EDGE DETAILS



WAVED EDGE

### LAYER CONFIGURATION

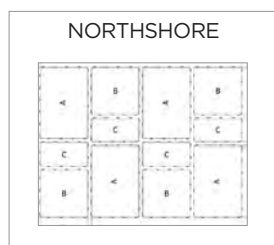

### LAYING PATTERNS

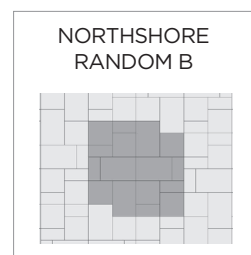
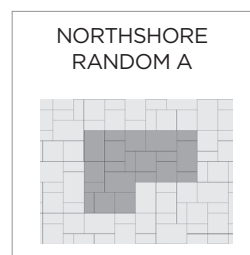

\*Colour selection should be chosen from actual samples.

**TECHNICAL INFORMATION**

**ASTM C 936 Standard Specifications for Solid Concrete Interlocking Paving Units**

- Conforms to:
    - C140 for Absorption 5% avg - 7% max
    - Compressive Strength > 7,200 PSI avg.
    - C67 for Freeze-thaw Durability
    - C418 for Abrasion Durability
    - Dimensional Accuracy **+/- 3mm**
- Test results available upon request*

**Meets the U.S. Architectural & Transportation Barrier Compliance Board Slip-Resistance Surfaces Advisory Guidelines**

**LEED INFORMATION**

**Materials & Resources: LEED V4:**

- Building Product Disclosure and Optimization
- Sourcing of Raw Materials - Sourcing of Raw Materials and Extraction • **1 point**
- Sourcing of Raw Materials - Leadership Extraction Practices • **1 point**
- Material Ingredient Reporting - Material Ingredient Reporting • **1 point**
- Material Ingredient Reporting - Material Ingredient Optimization • **1 point**
- Environmental Product Declaration • **1 point**

**TECHNICAL ADVANTAGES**

**ENDURACOLOR™**

Refined surface and long-lasting colour



Refined surface and long-lasting colour



Ultra-smooth surface texture

**DRIVE FRIENDLY**

Can handle vehicular loads  
*Ask about our base stabilization system*

**PRODUCT DATA**

Stones & Bundling	Unit Thickness	SqFt Per				Per Bundle		Soldier LnFt Per			Sailor LnFt per			Units Per			Lbs Per	
		Bundle	Layer	Section	Stone	Layers	Sections	Unit	Layer	Bundle	Unit	Layer	Bundle	SqFt	Layer	Bundle	Layer	Bundle
<b>Georgetown Manufacturing</b>																		
Random Bundle	2 3/4" (70mm)	93.0	11.625	-	-	8	-	-	-	-	-	11.81	94.48	1.03	12	96	372.33	2,978.63
Large Rectangle	2 3/4" (70mm)	-	-	-	2.09	-	-	-	-	-	1.47	-	47.04	0.69	4	32	-	-
Square	2 3/4" (70mm)	-	-	-	0.97	-	-	-	-	-	0.98	-	31.36	1.02	4	32	-	-
Small Rectangle	2 3/4" (70mm)	77.52	9.69	-	0.48	8	-	-	-	-	0.98	-	15.68	2.08	4	32	368.75	2,950
Small Rectangle		77.52	9.69	-	0.48	8	-	0.49	9.84	78.74	0.98	19.69	157.48	2.06	4	160	318.73	2,549.84

Notes: Sold in full bundles only on a refundable skid. **Minimum quantities apply on custom orders.** All measurements are nominal. **Important: A urethane rubber paver mat must be used to prevent scuffing.** For more information, samples or custom options, please contact your Unilock Territory Manager or call 1-800-UNILOCK.

**APPLICATIONS**



Pedestrian



Residential Vehicular



Commercial Vehicular  
*(Small Rectangle only)*



\*Wall pairing suggestion- U-CARA™

**RECOMMENDED SANDS**

**RECOMMENDED SEALER**



+



**Romex: Rompox® Fugensand**  
Pedestrian, Vehicular and Heavy Duty Vehicular Applications

- Manufactured from natural, raw materials
- Quick application
- Self-repairing properties
- Suitable for all load classes
- No cement haze/residue due to natural polymer binder
- Three colours: Natural, Stone Grey and Basalt

**Romex: Rompox® D7000 Joint Strengthener & Surface Sealer**  
Pedestrian, Vehicular and Heavy Duty Vehicular Applications

- All-in-one strengthener & sealer
- Eco-Friendly
- Protects against dirt, oil, corrosion from climate exposure, de-icing salts
- Protects against weed growth and wash outs

**Alliance Gator G2 MAXX Sand**

- Rain safe after 15 minutes (24hr no rain if concrete overlay)
- Sets above 32° F/ 0° C - may vary depending on weather, drainage, bedding materials and installation
- Dust free and haze free
- Requires only one watering
- Four colours: Beige, Grey, Black and Ivory

**Alliance Gator Natural Look Sealer**

- Water-based
- Zero gloss finish
- Multi purpose
- Rain safe after 24 hours

**Coverage:**

**Coverage:**

**Coverage:**

**Coverage:**

Colour	3mm Joints
Neutral, Stone Grey, Basalt <i>1 L / 5 gal</i>	110 sqft / 55 lb bag 750 sqft / 5 gal drum

Colour	3mm Joints
Neutral, Stone Grey, Basalt <i>55 lb bag / 1 kg can</i>	110 sqft / 55 lb bag 750 sqft / 5 gal drum

Colour	Narrow Joints	Wide Joints
Beige, Grey, Ivory <i>50 lb bag</i>	65-85 sqft	22-42 sqft
Black <i>50 lb bag</i>	58-76 sqft	20-38 sqft

Size	Area
3.78 L / 1 U.S. gal.	175 sqft
18.9 L / 5.28 U.S. gal.	875 sqft

\*Please refer to Sands & Sealers on pages 190-202 for more detailed information.

Unsured of bonded vs. unbonded product recommendations? Please contact your Unilock Territory Manager for more information.

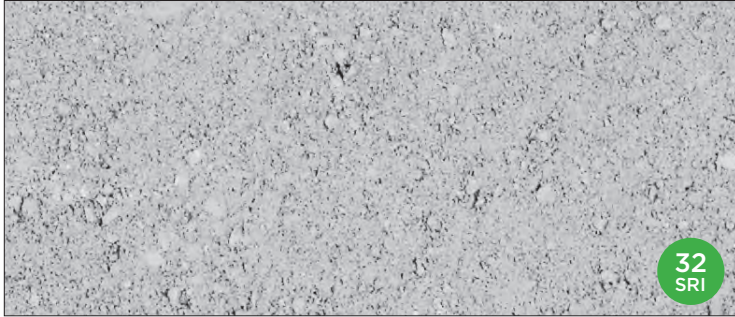

NATURAL



## VISUAL APPEARANCE

Optiloc™ is one of the best solutions for vehicular pavements. While maintaining a rectilinear look and feel, it possesses the same locking principal as its relative Anchorlock™ which is well recognized by unit paver specialists worldwide.

## FINISH

Both Optiloc™ and Anchorlock™ paver systems have the dual-axis engineering providing superior surface strength and high traffic performance. Ask us about customizing the colour and surface of this product.

## PRODUCT SPECIFICATIONS



### STANDARD

10¼ x 10¼ x 3⅞"  
260 x 260 x 80mm

## EDGE DETAILS



CHAMFERED

## LAYING PATTERNS

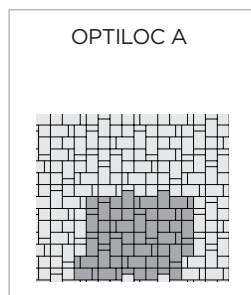

OPTILOC A  
100% Standard

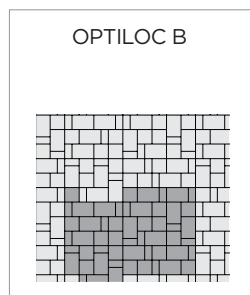

OPTILOC B  
100% Standard

\*Colour selection should be chosen from actual samples.



**TECHNICAL INFORMATION**

**ASTM C 936 Standard Specifications for Solid Concrete Interlocking Paving Units**

- Conforms to:
- C140 for Absorption 5% avg - 7% max
  - Compressive Strength > 7,200 PSI avg.
  - C67 for Freeze-thaw Durability
  - C418 for Abrasion Durability
  - Dimensional Accuracy **+/- 3 mm**
- Test results available upon request*

**Meets the U.S. Architectural & Transportation Barrier Compliance Board Slip-Resistance Surfaces Advisory Guidelines**

**SOLAR REFLECTIVE INDEX (SRI) TESTING DETAILS**

Product	Solar Reflectance	SRI
Natural	0.30	32 

**LEED INFORMATION**

- Materials & Resources: LEED V4:**
- Building Product Disclosure and Optimization
  - Sourcing of Raw Materials - Sourcing of Raw Materials and Extraction • **1 point**
  - Sourcing of Raw Materials - Leadership Extraction Practices • **1 point**
  - Material Ingredient Reporting - Material Ingredient Reporting • **1 point**
  - Material Ingredient Reporting - Material Ingredient Optimization • **1 point**
  - Environmental Product Declaration • **1 point**

**TECHNICAL ADVANTAGES**

**DRIVE FRIENDLY**

Can handle vehicular loads  
*Ask about our base stabilization system*

**PRODUCT DATA**

Stones & Bundling	Unit	SqFt Per				Per Bundle		Soldier LnFt Per			Sailor LnFt per			Units Per			Lbs Per		
	Thickness	Bundle	Layer	Section	Stone	Layers	Sections	Unit	Section	Bundle	Unit	Section	Bundle	SqFt	Section	Bundle	Layer	Section	Bundle
<b>Gormley Manufacturing</b>																			
Standard	3 1/8" (80mm)	93.14	11.64	-	0.61	8	-	-	-	-	-	-	-	1.63	-	152	426	-	3,409

Notes: This product is optimized for mechanical installation. Sold in full bundles only on a refundable skid. Minimum quantities may apply. All measurements are nominal. For more information, samples or custom options, please contact your Unilock Territory Manager or call 1-800-UNILOCK.

**APPLICATIONS**



Pedestrian



Residential Vehicular



Commercial Vehicular

**RECOMMENDED SANDS**

**RECOMMENDED SEALER**



**Romex: Rompox® Fugensand**  
Pedestrian, Vehicular and Heavy Duty Vehicular Applications

- Manufactured from natural, raw materials
- Quick application
- Self-repairing properties
- Suitable for all load classes
- No cement haze/residue due to natural polymer binder
- Three colours: Natural, Stone Grey and Basalt

**Romex: Rompox® D7000 Joint Strengthener & Surface Sealer**  
Pedestrian, Vehicular and Heavy Duty Vehicular Applications

- All-in-one strengthener & sealer
- Eco-Friendly
- Protects against dirt, oil, corrosion from climate exposure, de-icing salts
- Protects against weed growth and wash outs

**Alliance Gator G2 MAXX Sand**

- Rain safe after 15 minutes (24hr no rain if concrete overlay)
- Sets above 32° F/ 0° C - may vary depending on weather, drainage, bedding materials and installation
- Dust free and haze free
- Requires only one watering
- Four colours: Beige, Grey, Black and Ivory

**Alliance Gator Natural Look Sealer**

- Water-based
- Zero gloss finish
- Multi purpose
- Rain safe after 24 hours

**Coverage:**

Colour	3mm Joints
Neutral, Stone Grey, Basalt <i>1 L / 5 gal</i>	100 sqft / 55 lb bag 750 sqft/ 5 gal drum <i>(based on 1,000 sqft)</i>

**Coverage:**

Colour	3mm Joints
Neutral, Stone Grey, Basalt <i>55 lb bag / 1 kg can</i>	100 sqft / 55 lb bag 750 sqft/ 5 gal drum <i>(based on 1,000 sqft)</i>

**Coverage:**

Colour	Narrow Joints	Wide Joints
Beige, Grey, Ivory <i>50 lb bag</i>	65-85 sqft	22-42 sqft
Black <i>50 lb bag</i>	58-76 sqft	20-38 sqft

**Coverage:**

Size	Area
3.78 L / 1 U.S. gal.	175 sqft
18.9 L / 5.28 U.S. gal.	875 sqft

*\*Please refer to Sands & Sealers on pages 190-202 for more detailed information.*

*Unsure of bonded vs. unbonded product recommendations? Please contact your Unilock Territory Manager for more information.*

# PROMENADE™ PLANK PAVER

ENDURACOLOR™



OPAL BLEND  
4" x 12", 4" x 16", 8" x 24"



SANDSTONE  
4" x 12"



STEEL GREY BLEND  
4" x 12", 4" x 16", 8" x 24"



LIGHT GREY  
*IL CAMPO* FINISH  
4" x 12", 8" x 24"



GRANITE BLEND  
*IL CAMPO* FINISH  
4" x 12", 8" x 24"



DARK CHARCOAL  
*IL CAMPO* FINISH  
4" x 12", 8" x 24"



BLACK GRANITE  
*SERIES* FINISH  
4" x 12", 8" x 24"

## VISUAL APPEARANCE

Long and narrow design facilitates a linear laying pattern resulting in a finished and sleek appearance to complement current architectural design trends, leaving no compromise on style for heavy-duty functionality.

## FINISH

Available in a variety of Unilock Select finishes such as Il Campo®, Series™ (Stock) and Umbriano® (Custom), to name a few.

## PRODUCT SPECIFICATIONS



8 x 24 x 4"  
200 x 600 x 100mm  
See Slabs section page  
98 for more details



4 x 16 x 4"  
100 x 400 x 100mm



4 x 12 x 4"  
100 x 300 x 100mm

## EDGE DETAILS

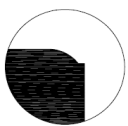

ROUNDED EDGE

## LAYING PATTERNS



PROMENADE PLANK  
PAVER A 8x24  
100% 8 x 24



PROMENADE PLANK  
PAVER C 4x16  
100% 4 x 16

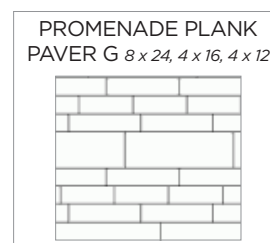

PROMENADE PLANK  
PAVER G 8 x 24, 4 x 16, 4 x 12  
40% 8 x 24, 40% 4 x 16,  
20% 4 x 12

\*Colour selection should be chosen from actual samples.

**UNILOCK**



**TECHNICAL INFORMATION**

**ASTM C 936 Standard Specifications for Solid Concrete Interlocking Paving Units**

- Conforms to:
- C140 for Absorption 5% avg - 7% max
  - Compressive Strength > 7,200 PSI avg.
  - C67 for Freeze-thaw Durability
  - C418 for Abrasion Durability
  - Dimensional Accuracy **+/- 3mm**
- Test results available upon request*

**Meets the U.S. Architectural & Transportation Barrier Compliance Board Slip-Resistance Surfaces Advisory Guidelines**

**SOLAR REFLECTIVE INDEX (SRI) TESTING DETAILS**

Product	Solar Reflectance	SRI
Opal Blend	0.32	34 
Steel Grey Blend	0.12	9 

**TECHNICAL ADVANTAGES**

**ENDURACOLOR™**

Refined surface and long-lasting colour

**DRIVE FRIENDLY**

Can handle vehicular loads  
*Ask about our base stabilization system*

**IL CAMPO FINISH**

Graphically interesting etched lines

**SERIES FINISH**

Granite, Quartz and Marble surface materials

**LEED INFORMATION**

**Materials & Resources: LEED V4:**

- Building Product Disclosure and Optimization
- Sourcing of Raw Materials - Sourcing of Raw Materials and Extraction • **1 point**
- Sourcing of Raw Materials - Leadership Extraction Practices • **1 point**
- Material Ingredient Reporting - Material Ingredient Reporting • **1 point**
- Material Ingredient Reporting - Material Ingredient Optimization • **1 point**
- Environmental Product Declaration • **1 point**

**PRODUCT DATA**

Stones & Bundling	Unit	SqFt Per				Per Bundle		Soldier LnFt Per			Sailor LnFt per			Units Per		Lbs Per	
	Thickness	Bundle	Layer	Section	Stone	Layers	Sections	Unit	Section	Bundle	Unit	Section	Bundle	SqFt	Bundle	Layer	Bundle
<b>Pickering Manufacturing</b>																	
8" x 24"	4" (100mm)	51.67	10.33	-	1.29	5	-	0.66	-	26.20	1.97	-	78.70	0.77	40	478	2,391
4" x 16"	4" (100mm)	51.67	10.33	-	0.43	5	-	0.33	-	39.40	1.31	-	157.50	2.32	120	488	2,440
4" x 12"	4" (100mm)	58.13	11.63	-	0.32	5	-	0.33	-	59.10	0.98	-	177.20	3.10	180	532	2,659

Notes: Sold in full bundles only on a refundable skid. **Important: A urethane rubber paver mat must be used to prevent scuffing.** All measurements are nominal. For more information, samples or custom options, please contact your Unilock Territory Manager or call 1-800-UNILOCK.

**APPLICATIONS**



Pedestrian



Residential Vehicular



Commercial Vehicular (4 x 12 x 4" only)



Borders and Accents



\*Wall pairing suggestion- U-CARA® Wall or Lineo™ Dimensional Stone

**RECOMMENDED SANDS**

**RECOMMENDED SEALER**



**Romex: Rompox® Fugensand**  
Pedestrian, Vehicular and Heavy Duty Vehicular Applications

- Manufactured from natural, raw materials
- Quick application
- Self-repairing properties
- Suitable for all load classes
- No cement haze/residue due to natural polymer binder
- Three colours: Natural, Stone Grey and Basalt

**Coverage:**

Colour	3mm Joints
Neutral, Stone Grey, Basalt <i>1 L / 5 gal</i>	110 sqft / 55 lb bag 750 sqft / 5 gal drum

**Romex: Rompox® D7000 Joint Strengthener & Surface Sealer**  
Pedestrian, Vehicular and Heavy Duty Vehicular Applications

- All-in-one strengthener & sealer
- Eco-Friendly
- Self-repairing properties
- Protects against dirt, oil, corrosion from climate exposure, de-icing salts
- Protects against weed growth and wash outs

**Coverage:**

Colour	3mm Joints
Neutral, Stone Grey, Basalt <i>55 lb bag / 1 kg can</i>	110 sqft / 55 lb bag 750 sqft / 5 gal drum

**Alliance Gator G2 MAXX Sand**

- Rain safe after 15 minutes (24hr no rain if concrete overlay)
- Sets above 32° F / 0° C - may vary depending on weather, drainage, bedding materials and installation
- Dust free and haze free
- Requires only one watering
- Four colours: Beige, Grey, Black and Ivory

**Coverage:**

Colour	Narrow Joints	Wide Joints
Beige, Grey, Ivory <i>50 lb bag</i>	65-85 sqft	22-42 sqft
Black <i>50 lb bag</i>	58-76 sqft	20-38 sqft

**Alliance Gator Hybrid Low Gloss + Colour Enhancer**

- Water-based
- Low gloss finish
- Vibrant Colour Enhancer
- Rain safe after 24 hours

**Coverage:**

Size	Area
3.78 L / 1 U.S. gal.	200 sqft
18.9 L / 5.28 U.S. gal.	1,000 sqft

\*Please refer to Sands & Sealers on pages 190-202 for more detailed information.

Unsure of bonded vs. unbonded product recommendations? Please contact your Unilock Territory Manager for more information.

# REVELA™

## ENDURACOLOR™



FROST **NEW**



METALLIC GREY

18  
SRI



MICA GREY  
ONLY AVAILABLE IN 80MM RANDOM BUNDLE

24  
SRI



SAVANNAH

### VISUAL APPEARANCE

Advanced processing technologies are used to reveal a variety of unique colours and textures on the surface of this product.

### FINISH

Enhanced surface appearance. Granite, Quartz and Marble surface materials.

### PRODUCT SPECIFICATIONS



**LARGE RECTANGLE**  
14 x 21 x 3½"  
360 x 540 x 80mm



**SQUARE**  
14 x 14 x 3½"  
360 x 360 x 80mm



**SMALL RECTANGLE**  
7 x 14 x 3½"  
180 x 360 x 80mm



**SLAB**  
21 x 35 x 2¾"  
540 x 890 x 60mm  
See Slabs section page  
100 for more details



4 x 12 x 4"  
100 x 300 x 100mm  
*Metallic Grey only*

3 UNIT RANDOM BUNDLE

### EDGE DETAILS

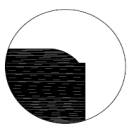

ROUNDED EDGE

### BUNDLE CONFIGURATION



\*Colour selection should be chosen from actual samples.

**TECHNICAL INFORMATION**

**ASTM C 936 Standard Specifications for Solid Concrete Interlocking Paving Units**



Conforms to:

- C140 for Absorption 5% avg - 7% max
- Compressive Strength > 7,200 PSI avg.
- C67 for Freeze-thaw Durability
- C418 for Abrasion Durability
- Dimensional Accuracy **+/- 3mm**

*Test results available upon request*

**Meets the U.S. Architectural & Transportation Barrier Compliance Board Slip-Resistance Surfaces Advisory Guidelines**

**SOLAR REFLECTIVE INDEX (SRI) TESTING DETAILS**

Product	Solar Reflectance	SRI
Metallic Grey	0.19	18 
Mica Grey	0.24	24 

**TECHNICAL ADVANTAGES**

**ENDURACOLOR™**

Refined surface and long-lasting colour  
Enhanced surface appearance

**DRIVE FRIENDLY**

Can handle vehicular loads  
*Ask about our base stabilization system*  
*\*Does not apply to Revela Slab*

**LEED INFORMATION**

**Materials & Resources: LEED V4:**

- Building Product Disclosure and Optimization
- Sourcing of Raw Materials - Sourcing of Raw Materials and Extraction • **1 point**
- Sourcing of Raw Materials - Leadership Extraction Practices • **1 point**
- Material Ingredient Reporting - Material Ingredient Reporting • **1 point**
- Material Ingredient Reporting - Material Ingredient Optimization • **1 point**
- Environmental Product Declaration • **1 point**

**PRODUCT DATA**

Stones & Bundling	Unit	SqFt Per				Per Bundle		Soldier LnFt per			Sailor LnFt per			Units Per			Lbs Per		
	Thickness	Bundle	Layer	Section	Stone	Layers	Section	Unit	Section	Bundle	Unit	Section	Bundle	SqFt	Layer	Bundle	Layer	Section	Bundle
<b>Georgetown Manufacturing</b>																			
	21 x 35"	2 3/8" (60mm)	62.78	10.46	-	5.23	6	-			-	-	-	-	-	12	287	-	1,723
Random Bundle			73.24	10.46	-	1.308	7	-			0.985	-	62.01	0.77	-	56	383	-	2,680
Large Rectangle	3 1/8" (80mm)	-	-	-	2.089	-	-				1.771	-	24.8	0.48	-	14	-	-	-
Small Rectangle	3 1/8" (80mm)	-	-	-	0.698	-	-				0.591	-	12.4	1.43	-	21	-	-	-
Square	3 1/8" (80mm)	-	-	-	1.395	-	-				1.181	-	24.8	0.72	-	21	-	-	-
4 x 12"	4" (100mm)	53.13	10.63		0.3	5	-	0.33	-	59.4	0.98		177.15	3.39	-	180	531.77	-	2,658.87

Notes: Sold in full bundles only on a refundable skid. **Important: A urethane rubber paver mat must be used to prevent scuffing.** All measurements are nominal. For more information, samples or custom options, please contact your Unilock Territory Manager or call 1-800-UNILOCK.

**APPLICATIONS**



Pedestrian



Residential Vehicular (Random bundle only)



Commercial Vehicular (Random bundle only)

 \*Wall pairing suggestion- U-CARA® Wall or Lineo™ Dimensional Stone

**RECOMMENDED SANDS**

**RECOMMENDED SEALER**



+



**Romex: Rompox® Fugensand**

**Pedestrian, Vehicular and Heavy Duty Vehicular Applications**

- | Manufactured from natural, raw materials
- | Quick application
- | Self-repairing properties
- | Suitable for all load classes
- | No cement haze/residue due to natural polymer binder
- | Three colours: Natural, Stone Grey and Basalt

Coverage:

Colour	3mm Joints
Neutral, Stone Grey, Basalt <i>1 L / 5 gal</i>	110 sqft / 55 lb bag 750 sqft / 5 gal drum

**Romex: Rompox® D7000 Joint Strengthener & Surface Sealer**

**Pedestrian, Vehicular and Heavy Duty Vehicular Applications**

- | All-in-one strengthener & sealer
- | Eco-Friendly
- | Protects against dirt, oil, corrosion from climate exposure, de-icing salts
- | Protects against weed growth and wash outs

Coverage:

Colour	3mm Joints
Neutral, Stone Grey, Basalt <i>55 lb bag / 1 kg can</i>	110 sqft / 55 lb bag 750 sqft / 5 gal drum

**Alliance Gator G2 MAXX Sand**

- | Rain safe after 15 minutes (24hr no rain if concrete overlay)
- | Sets above 32° F/ 0° C - may vary depending on weather, drainage, bedding materials and installation
- | Dust free and haze free
- | Requires only one watering
- | Four colours: Beige, Grey, Black and Ivory

Coverage:

Colour	Narrow Joints	Wide Joints
Beige, Grey, Ivory <i>50 lb bag</i>	65-85 sqft	22-42 sqft
Black <i>50 lb bag</i>	58-76 sqft	20-38 sqft

**Alliance Gator Hybrid Low Gloss + Colour Enhancer**

- | Water-based
- | Low gloss finish
- | Vibrant Colour Enhancer
- | Rain safe after 24 hours

Coverage:

Size	Area
3.78 L / 1 U.S. gal.	200 sqft
18.9 L / 5.28 U.S. gal.	1,000 sqft

*\*Please refer to Sands & Sealers on pages 190-202 for more detailed information.*

*Unsure of bonded vs. unbonded product recommendations? Please contact your Unilock Territory Manager for more information.*



DAWN MIST



PEBBLE TAUPE



DAWN MIST/PEBBLE TAUPE

*Sold separately / Blended on site*

## VISUAL APPEARANCE

Inspired by the texture of natural cut flagstone. Finished projects will have a completely random, and natural appearance.

## FINISH

Flagstone finish. Reala™ Technology provides realistic texture cast from natural stone.

## PRODUCT SPECIFICATIONS



### RECTANGLE

9 x 12 x 2<sup>3</sup>/<sub>8</sub>"  
226 x 300 x 60mm



### SQUARE

9 x 9 x 2<sup>3</sup>/<sub>8</sub>"  
226 x 226 x 60mm



### SMALL RECTANGLE

6 x 9 x 2<sup>3</sup>/<sub>8</sub>"  
150 x 226 x 60mm

3 UNIT RANDOM BUNDLE

## EDGE DETAILS



ROUNDED EDGE

## BUNDLE CONFIGURATION

### RICHCLIFF RANDOM BUNDLE

E1	D1	C1	B1	A1
E2	D2	C2	B2	A2
E3	D3	C3	B3	A3
E4	D4	C4	B4	A4

## LAYING PATTERNS

### RICHCLIFF A

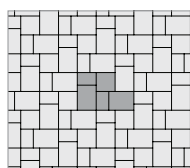

### RICHCLIFF A

53% 9 x 12, 20% 9 x 9,  
27% 6 x 9

### RICHCLIFF B

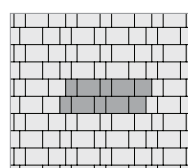

### RICHCLIFF B

53% 9 x 12, 20% 9 x 9,  
27% 6 x 9

\*Colour selection should be chosen from actual samples.

**TECHNICAL INFORMATION**

**ASTM C 936 Standard Specifications for Solid Concrete Interlocking Paving Units**

- Conforms to:
- C140 for Absorption 5% avg - 7% max
  - Compressive Strength > 7,200 PSI avg.
  - C67 for Freeze-thaw Durability
  - C418 for Abrasion Durability
  - Dimensional Accuracy **+/- 3 mm**
- Test results available upon request*

**Meets the U.S. Architectural & Transportation Barrier Compliance Board Slip-Resistance Surfaces Advisory Guidelines**

**LEED INFORMATION**

**Materials & Resources: LEED V4:**

- Building Product Disclosure and Optimization
- Sourcing of Raw Materials - Sourcing of Raw Materials and Extraction • **1 point**
- Sourcing of Raw Materials - Leadership Extraction Practices • **1 point**
- Material Ingredient Reporting - Material Ingredient Reporting • **1 point**
- Material Ingredient Reporting - Material Ingredient Optimization • **1 point**
- Environmental Product Declaration • **1 point**

**TECHNICAL ADVANTAGES**



Deep rich colours and unique textures

**REALA™**

Cast from natural stone

**ULTIMA™**

Up to 4x stronger than poured-in-place concrete

**DRIVE FRIENDLY**

Random bundle can handle vehicular loads  
*Ask about our base stabilization system*



Factory sealed for integral stain resistance

**PRODUCT DATA**

Stones & Bundling	Unit		SqFt Per			Per Bundle		Soldier LnFt Per		Sailor LnFt per		Units Per			Lbs Per				
	Thickness	Bundle	Layer	Section	Stone	Layers	Sections	Unit	Section	Bundle	Unit	Section	Bundle	SqFt	Layer	Bundle	Unit	Layer	Bundle
<b>Ayr Manufacturing</b>																			
Random Bundle		90.30	11.29	-	0.56	8	-	-	-	-	1.31	-	118.22	1.77	-	160	15.45	309	2,472
Rectangle	2 3/4" (6cm)	-	-	-	0.73	-	-	-	-	-	0.98	-	63.00	1.37	-	64	-	-	-
Square	2 3/4" (6cm)	-	-	-	0.55	-	-	-	-	-	0.74	-	23.70	1.82	-	32	-	-	-
Small Rectangle	2 3/4" (6cm)	-	-	-	0.37	-	-	-	-	-	0.49	-	47.50	2.74	-	64	-	-	-

Notes: Sold as full bundles only on a refundable skid. All measurements are nominal. **Important: A urethane rubber paver mat must be used to prevent scuffing.** For more information, samples or custom options, please contact your Unilock Territory Manager or call 1-800-UNILOCK.

**APPLICATIONS**



Pedestrian



Residential Vehicular (*Random Bundle only*)



Borders and Accents



\*Wall pairing suggestion- U-Cara® Wall

**RECOMMENDED SANDS**

**RECOMMENDED SEALER**



**Romex: Rompox® ECO-Fine**  
Pedestrian Applications only

- | Ready mixed and easy to use
- | Resin film free
- | Resistant to ants, weeds, de-icing salts
- | Made from 98% natural, recycled or renewable raw materials
- | Pressure washer safe
- | Ideal for joint widths from 5mm (1/4")

**Coverage:**

Colour	5-6mm Joints
Beige, Stone Grey, Anthracite 55 lb bag / 1 kg can	125 sqft / 55 lb mix



**Romex: Rompox® Drain**  
Vehicular Applications

- | Resin film-free
- | Highly water permeable
- | Self-compacting and water emulsifiable
- | Resistant to ants, weeds, de-icing salts
- | Pressure washer safe
- | Ideal for joint widths from 3mm (1/4")
- | Ideal for driveways, parking spaces and all vehicular loading applications up to 3.5 T
- | Three colours: Neutral, Stone Grey and Basalt

**Coverage:**

Colour	7mm Joints
Neutral, Stone Grey, Basalt Two 1 L bottles to be mixed with one 55 lb bag of Romex approved sand	20 sqft / 55 lb mix (based on 1,000 sqft)



**Alliance Gator G2 MAXX Sand**

- | Rain safe after 15 minutes (24hr no rain if concrete overlay)
- | Sets above 32° F/ 0° C - may vary depending on weather, drainage, bedding materials and installation
- | Dust free and haze free
- | Requires only one watering
- | Four colours: Beige, Grey, Black and Ivory

**Coverage:**

Colour	Narrow Joints	Wide Joints
Beige, Grey, Ivory 50 lb bag	65-85 sqft	22-42 sqft
Black 50 lb bag	58-76 sqft	20-38 sqft



**Alliance - Gator Seal Satin Look**

- | Solvent-based
- | Low gloss finish
- | Vibrant colour enhancer
- | Rain safe after 90 minutes
- | Helps resist corrosion from de-icing salt, ultra-violet rays effects, motor oils and grease stains

**Coverage:**

Size	Area
3.78 L / 1 U.S. gal.	175 sqft

\*Please refer to Sands & Sealers on pages 190-202 for more detailed information.

Unsure of bonded vs. unbonded product recommendations? Please contact your Unilock Territory Manager for more information.

# SERIES™ 70mm

## ENDURACOLOR™



**BLACK GRANITE**  
4 x 8, 8 x 8, 8 x 16



**GLACIER**  
8 x 8, 8 x 16

46  
SRI



**MOUNTAIN MIST**  
8 x 8, 8 x 16

29  
SRI

### VISUAL APPEARANCE

Series' specialized manufacturing process creates a striking visual effect with the surface granite particles and also results in an extremely durable paver.

### FINISH

The aggregate surface is pressed into the stone surface simultaneously with the body of the stone in a single process and not in layers. The resulting surface becomes an integral part of the paver itself, giving you long-term wear and structural performance.

### PRODUCT SPECIFICATIONS



4 x 8 x 2¾"  
100 x 200 x 70mm  
*Black Granite only*

8 x 8 x 2¾"  
200 x 200 x 70mm

8 x 16 x 2¾"  
200 x 400 x 70mm

### EDGE DETAILS



ROUNDED EDGE

### LAYING PATTERNS

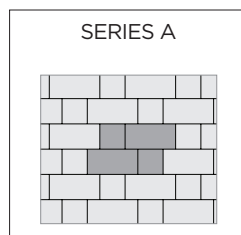

**SERIES A**  
67% 8 x 16,  
33% 8 x 8

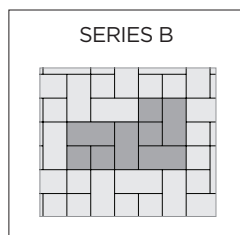

**SERIES B**  
67% 8 x 16,  
33% 8 x 8

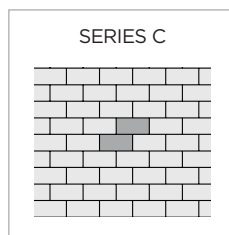

**SERIES C**  
100% 4 x 8

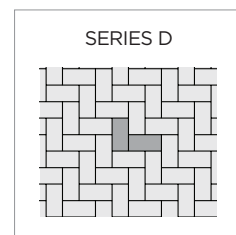

**SERIES D**  
100% 4 x 8

\*Colour selection should be chosen from actual samples.





**TECHNICAL INFORMATION**

**ASTM C 936 Standard Specifications for Solid Concrete Interlocking Paving Units**

- Conforms to:
- C140 for Absorption 5% avg - 7% max
  - Compressive Strength > 7,200 PSI avg.
  - C67 for Freeze-thaw Durability
  - C418 for Abrasion Durability
  - Dimensional Accuracy **+/- 3mm**
- Test results available upon request*

**Meets the U.S. Architectural & Transportation Barrier Compliance Board Slip-Resistance Surfaces Advisory Guidelines**

**SOLAR REFLECTIVE INDEX (SRI) TESTING DETAILS**

Product	Solar Reflectance	SRI
Glacier	0.41	46 
Mountain Mist	0.28	29 

**TECHNICAL ADVANTAGES**

**ENDURACOLOR™**

Refined surface and long-lasting colour

**DRIVE FRIENDLY**

Can handle vehicular loads  
*Ask about our base stabilization system*

**SERIES FINISH**

Granite, Quartz and Marble surface materials

**LEED INFORMATION**

**Materials & Resources: LEED V4:**

- Building Product Disclosure and Optimization  
Sourcing of Raw Materials - Sourcing of Raw Materials and Extraction • **1 point**  
Sourcing of Raw Materials - Leadership Extraction Practices • **1 point**  
Material Ingredient Reporting - Material Ingredient Reporting • **1 point**  
Material Ingredient Reporting - Material Ingredient Optimization • **1 point**  
Environmental Product Declaration • **1 point**

**PRODUCT DATA**

Stones & Bundling	Unit Thickness	SqFt Per				Per Bundle		Soldier LnFt Per			Sailor LnFt per			Units Per		Lbs Per	
		Bundle	Layer	Section	Stone	Layers	Sections	Unit	Section	Bundle	Unit	Section	Bundle	SqFt	Bundle	Layer	Bundle
<b>Georgetown Manufacturing</b>																	
Series 70mm																	
4" x 8"	2¾" (70mm)	94.40	11.80		0.22	8	-	0.33	-	141.7	0.67	-	283.30	4.57	432	377	3,019
8" x 16"	2¾" (70mm)	82.67	10.33		0.86	8	-	0.66	-	63.0	1.31	-	126.00	1.16	96	343	2,746
8" x 8"	2¾" (70mm)	82.67	10.33		0.46	8	-	0.66	-	126.0	0.66	-	126.00	2.32	192	331	2,647

Notes: Custom colors and finishes available. Minimum quantities apply. Sold on a refundable skid. See terms and conditions of sale. All measurements are nominal.  
**Important:** A urethane rubber paver mat must be used to prevent scuffing. **Polymeric Sand advisory.** For more information, samples or custom options, please contact your Unilock Territory Manager or call 1-800-UNILOCK.

**APPLICATIONS**



Pedestrian



Residential Vehicular



Commercial Vehicular (4 x 8 x 2 ¾" & 8 x 8 x 2 ¾" only)



Borders and Accents



Roof Decks



\*Wall pairing suggestion- U-CARA® Wall

**RECOMMENDED SANDS**

**RECOMMENDED SEALER**



**Romex: Rompox® Fugensand**  
Pedestrian, Vehicular and Heavy Duty Vehicular Applications

- | Manufactured from natural, raw materials
- | Quick application
- | Self-repairing properties
- | Suitable for all load classes
- | No cement haze/residue due to natural polymer binder
- | Three colours: Natural, Stone Grey and Basalt

**Coverage:**

Colour	3mm Joints
Neutral, Stone Grey, Basalt <i>1 L / 5 gal</i>	110 sqft / 55 lb bag 750 sqft / 5 gal drum

**Romex Rompox® D7000 Joint Strengthener & Surface Sealer**  
Pedestrian, Vehicular and Heavy Duty Vehicular Applications

- | All-in-one strengthener & sealer
- | Eco-Friendly
- | Protects against dirt, oil, corrosion from climate exposure, de-icing salts
- | Protects against weed growth and wash outs

**Coverage:**

Colour	3mm Joints
Neutral, Stone Grey, Basalt <i>55 lb bag / 1 kg can</i>	110 sqft / 55 lb bag 750 sqft / 5 gal drum

**Alliance Gator G2 MAXX Sand**

- | Rain safe after 15 minutes (24hr no rain if concrete overlay)
- | Sets above 32° F/ 0° C - may vary depending on weather, drainage, bedding materials and installation
- | Dust free and haze free
- | Requires only one watering
- | Four colours: Beige, Grey, Black and Ivory

**Coverage:**

Colour	Narrow Joints	Wide Joints
Beige, Grey, Ivory <i>50 lb bag</i>	65-85 sqft	22-42 sqft
Black <i>50 lb bag</i>	58-76 sqft	20-38 sqft

**Alliance Gator Natural Look Sealer**

- | Water-based
- | Zero gloss finish
- | Multi purpose
- | Rain safe after 24 hours

**Coverage:**

Size	Area
3.78 L / 1 U.S. gal.	175 sqft
18.9 L / 5.28 U.S. gal.	875 sqft

\*Please refer to Sands & Sealers on pages 190-202 for more detailed information.

Unsured of bonded vs. unbonded product recommendations? Please contact your Unilock Territory Manager for more information.

# SERIES™ 100mm

ENDURACOLOR™

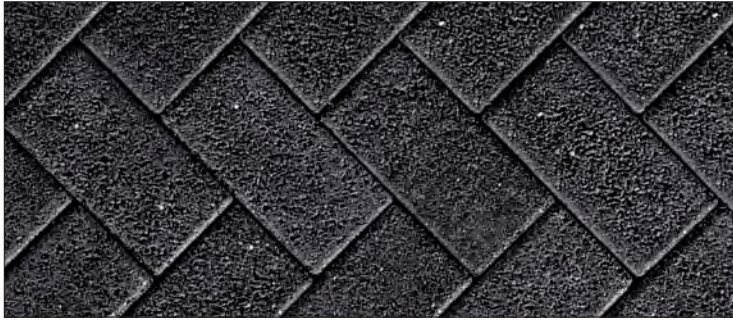

BLACK GRANITE

## VISUAL APPEARANCE

Series' specialized manufacturing process creates a striking visual effect with the surface granite particles and also results in an extremely durable paver. results in an extremely durable paver.

## FINISH

The aggregate surface is pressed into the stone surface simultaneously with the body of the stone in a single process and not in layers. The resulting surface becomes an integral part of the paver itself, giving you long-term wear and structural performance.

## PRODUCT SPECIFICATIONS



8 x 24 x 4"  
200 x 600 x 100mm



4 x 12 x 4"  
100 x 300 x 100mm

## EDGE DETAILS



ROUNDED EDGE

## LAYING PATTERNS

PROMENADE PLANK  
PAVER A 4X12

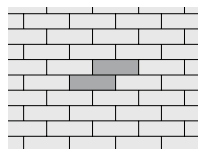

PROMENADE PLANK PAV  
100% 4 x 12

PROMENADE PLANK  
PAVER B 4X12

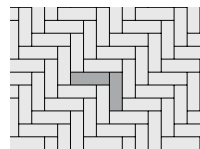

PROMENADE PLANK PAV  
100% 4 x 12

PROMENADE PLANK  
PAVER A 8X24

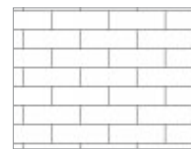

PROMENADE PLANK PAV  
100% 8 x 24

\*Colour selection should be chosen from actual samples.

**TECHNICAL INFORMATION**

**ASTM C 936 Standard Specifications for Solid Concrete Interlocking Paving Units**

- Conforms to:
- C140 for Absorption 5% avg - 7% max
  - Compressive Strength > 7,200 PSI avg.
  - C67 for Freeze-thaw Durability
  - C418 for Abrasion Durability
  - Dimensional Accuracy **+/- 3mm**
- Test results available upon request*

**Meets the U.S. Architectural & Transportation Barrier Compliance Board Slip-Resistance Surfaces Advisory Guidelines**

**LEED INFORMATION**

**Materials & Resources: LEED V4:**

- Building Product Disclosure and Optimization
- Sourcing of Raw Materials - Sourcing of Raw Materials and Extraction • **1 point**
- Sourcing of Raw Materials - Leadership Extraction Practices • **1 point**
- Material Ingredient Reporting - Material Ingredient Reporting • **1 point**
- Material Ingredient Reporting - Material Ingredient Optimization • **1 point**
- Environmental Product Declaration • **1 point**

**TECHNICAL ADVANTAGES**

**ENDURACOLOR™**

Refined surface and long-lasting colour

**DRIVE FRIENDLY**

Can handle vehicular loads  
*Ask about our base stabilization system*  
*\*Does not apply to 8 x 24 x 4"*

**SERIES FINISH**

Granite, Quartz and Marble surface materials

**PRODUCT DATA**

Stones & Bundling	Unit Thickness	SqFt Per				Per Bundle		Soldier LnFt Per			Sailor LnFt per			Units Per			Lbs Per		
		Bundle	Layer	Section	Stone	Layers	Sections	Unit	Section	Bundle	Unit	Section	Bundle	SqFt	Section	Bundle	Layer	Section	Bundle
<b>Georgetown Manufacturing</b>																			
Series 100mm																			
4" x 12"	4" (100mm)	58.13	11.63	-	0.32	5	-	0.33	-	59.10	0.98	-	177.20	3.10	-	180	532	-	2,659
8" x 24"	4" (100mm)	51.67	10.33	-	1.29	5	-	0.66	-	26.20	1.97	-	78.70	0.77	-	40	478	-	2,391

Notes: Custom colors and finishes available. Minimum quantities apply. Sold on a refundable skid. See terms and conditions of sale. All measurements are nominal. **Important: A urethane rubber paver mat must be used to prevent scuffing. Polymeric Sand advisory.** For more information, samples or custom options, please contact your Unilock Territory Manager or call 1-800-UNILOCK.

**APPLICATIONS**



Pedestrian



Residential Vehicular



Commercial Vehicular (4 x 12 x 4" only)



Roof Decks



Borders and Accents



\*Wall pairing suggestion- U-CARA® Wall

**RECOMMENDED SANDS**

**RECOMMENDED SEALER**



+



**Romex: Rompox® Fugensand**

- Pedestrian, Vehicular and Heavy Duty Vehicular Applications**
- Manufactured from natural, raw materials
- Quick application
- Self-repairing properties
- Suitable for all load classes
- No cement haze/residue due to natural polymer binder
- Three colours: Natural, Stone Grey and Basalt

**Coverage:**

Colour	3mm Joints
Neutral, Stone Grey, Basalt 1 L / 5 gal	110 sqft / 55 lb bag 750 sqft / 5 gal drum

**Romex: Rompox® D7000 Joint Strengthener & Surface Sealer**

- Pedestrian, Vehicular and Heavy Duty Vehicular Applications**
- All-in-one strengthener & sealer
- Eco-Friendly
- Protects against dirt, oil, corrosion from climate exposure, de-icing salts
- Protects against weed growth and wash outs

**Coverage:**

Colour	3mm Joints
Neutral, Stone Grey, Basalt 55 lb bag / 1 kg can	110 sqft / 55 lb bag 750 sqft / 5 gal drum

**Alliance Gator G2 MAXX Sand**

- Rain safe after 15 minutes (24hr no rain if concrete overlay)
- Sets above 32° F / 0° C - may vary depending on weather, drainage, bedding materials and installation
- Dust free and haze free
- Requires only one watering
- Four colours: Beige, Grey, Black and Ivory

**Coverage:**

Colour	Narrow Joints	Wide Joints
Beige, Grey, Ivory 50 lb bag	65-85 sqft	22-42 sqft
Black 50 lb bag	58-76 sqft	20-38 sqft

**Alliance Gator Natural Look Sealer**

- Water-based
- Zero gloss finish
- Multi purpose
- Rain safe after 24 hours

**Coverage:**

Size	Area
3.78 L / 1 U.S. gal.	175 sqft
18.9 L / 5.28 U.S. gal.	875 sqft

\*Please refer to Sands & Sealers on pages 190-202 for more detailed information.

Unsure of bonded vs. unbonded product recommendations? Please contact your Unilock Territory Manager for more information.

# TOWN HALL®

Exclusive to **UNILOCK**



**ELEGANCE**  **PERMEABLE**



BASALT



BURGUNDY RED



BURNT CLAY



OLD OAK



3 COLOUR BLEND  
*Blended on site*

## VISUAL APPEARANCE

The substantial proportions and unique colour blending of Town Hall® is modelled after historic North American clay street pavers. The timeless look of Town Hall® can be installed in either traditional or permeable applications for vehicular, heavy duty and pedestrian applications. The result is vintage, streetscape charm that stands the test of time.

## FINISH

Town Hall® textures are cast from a multitude of different surfaces using Realta™ Technology, and Ultima™ Technology to create superior durability of this cobblestone appearance.

## PRODUCT SPECIFICATIONS



**STANDARD**  
4" x 9¾" x 2¾"  
100 x 250 x 70mm

## EDGE DETAILS



ROUNDED EDGE

## LAYING PATTERNS

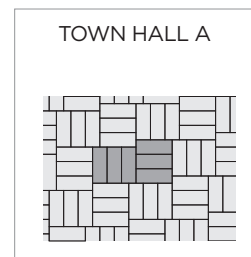

TOWN HALL A  
*100% Standard*

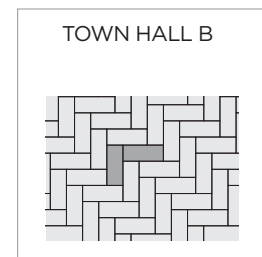

TOWN HALL B  
*100% Standard*

## PERMEABLE PAVEMENT DATA

					MIN. INFILTRATION RATE FOR RAINFALL OF:			
ADA COMPLIANT	JOINT MATERIAL	JOINT WIDTH*	VOID SPACE*	SURFACE INFILTRATION RATE**	2" / HR	4.5" / HR	6.5" / HR	11" / HR
					Medium: ¼" - ⅝" Joint			
	Kafka - 1/8 to 3/16"	9mm	6.5%	784" / HR	31	69	100	169

\*Joint Width is measured at the top of the paver. Void Space is calculated at the base of the paver. \*\*Infiltration rate is based on testing done when first installed and is an approximate. Permeable spacers are available for use with extended range of Unilock products.

\*Colour selection should be chosen from actual samples.

**TECHNICAL INFORMATION**

**ASTM C 936 Standard Specifications for Solid Concrete Interlocking Paving Units**

- Conforms to:
- C140 for Absorption 5% avg - 7% max
  - Compressive Strength > 7,200 PSI avg.
  - C67 for Freeze-thaw Durability
  - C418 for Abrasion Durability
  - Dimensional Accuracy **+/- 3mm**
- Test results available upon request*

**Meets the U.S. Architectural & Transportation Barrier Compliance Board Slip-Resistance Surfaces Advisory Guidelines**

**LEED INFORMATION**

- Materials & Resources: LEED V4:**
- Building Product Disclosure and Optimization
  - Sourcing of Raw Materials - Sourcing of Raw Materials and Extraction • **1 point**
  - Sourcing of Raw Materials - Leadership Extraction Practices • **1 point**
  - Material Ingredient Reporting - Material Ingredient Reporting • **1 point**
  - Material Ingredient Reporting - Material Ingredient Optimization • **1 point**
  - Environmental Product Declaration • **1 point**

**TECHNICAL ADVANTAGES**

- ELEGANCE**  
Deep, rich colours with unique textures
- REALA™**  
Cast from historic brick
- ULTIMA™**  
Up to 4x stronger than poured-in-place concrete

- PERMEABLE**  
Can be installed to allow water to flow through
- EasyClean**  
Factory sealed for integral stain resistance

- DRIVE FRIENDLY**  
Can handle vehicular loads  
*Ask about our base stabilization system*

**PRODUCT DATA**

Stones & Bundling	Unit Thickness	SqFt Per			Per Bundle		Soldier LnFt Per		Sailor LnFt per		Units Per			Lbs Per					
		Bundle	Layer	Section	Stone	Layers	Sections	Unit	Section	Bundle	Unit	Section	Bundle	SqFt	Section	Bundle	Layer	Section	Bundle
<b>Ayr Manufacturing</b>																			
Standard	2¾ (70mm)	88.41	11.05	-	0.28	8	-	0.34	-	104.99	0.82	-	262.50	3.62	-	320	361	-	2,888

Notes: Sold in full bundles only on a refundable skid. All measurements are nominal. **Important: A urethane rubber paver mat must be used to prevent scuffing.** For more information, samples or custom options, please contact your Unilock Territory Manager or call 1-800-UNILOCK.

**APPLICATIONS**

- Pedestrian
- Residential Vehicular
- Commercial Vehicular
- Permeable
- Borders and Accents
- \*Wall pairing suggestion- U-CARA® Wall or Lineo™ Dimensional Stone

**RECOMMENDED SANDS**

**RECOMMENDED SEALER**



**Romex: Rompox® ECO-Fine**  
Pedestrian Applications only

- | Ready mixed and easy to use
- | Resin film free
- | Resistant to ants, weeds, de-icing salts
- | Made from 98% natural, recycled or renewable raw materials
- | Pressure washer safe
- | Ideal for joint widths from 5mm (1/4")



**Romex: Rompox® Drain**  
Vehicular Applications

- | Resin film-free
- | Highly water permeable
- | Self-compacting and water emulsifiable
- | Resistant to ants, weeds, de-icing salts
- | Pressure washer safe
- | Ideal for joint widths from 3mm (1/4")
- | Ideal for driveways, parking spaces and all vehicular loading applications up to 3.5 T
- | Three colours: Neutral, Stone Grey and Basalt



**Alliance Gator G2 MAXX Sand**

- | Rain safe after 15 minutes (24hr no rain if concrete overlay)
- | Sets above 32° F/ 0° C - may vary depending on weather, drainage, bedding materials and installation
- | Dust free and haze free
- | Requires only one watering
- | Four colours: Beige, Grey, Black and Ivory



**Alliance Gator Seal Satin Look**

- | Solvent-based
- | Low gloss finish
- | Vibrant colour enhancer
- | Rain safe after 90 minutes
- | Helps resist corrosion from de-icing salt, ultra-violet rays effects, motor oils and grease stains

**Coverage:**

Colour	5-6mm Joints
Beige, Stone Grey, Anthracite 55 lb bag / 1 kg can	125 sqft / 55 lb mix

**Coverage:**

Colour	6mm Joints
Neutral, Stone Grey, Basalt Two 1 L bottles to be mixed with one 55 lb bag of Romex approved sand	25 sqft / 55 lb mix (based on 1,000 sqft)

**Coverage:**

Colour	Narrow Joints	Wide Joints
Beige, Grey, Ivory 50 lb bag	65-85 sqft	22-42 sqft
Black 50 lb bag	58-76 sqft	20-38 sqft

**Coverage:**

Size	Area
3.78 L / 1 U.S. gal.	175 sqft

\*Please refer to Sands & Sealers on pages 190-202 for more detailed information.  
 Unsure of bonded vs. unbonded product recommendations? Please contact your Unilock Territory Manager for more information.

# TREO<sup>®</sup> SMOOTH

CLASSIC  PERMEABLE



GRANITE BLEND

## VISUAL APPEARANCE

Treo<sup>®</sup> Smooth offers a smooth surface texture for a sleek, modern look.

## FINISH

Smooth, classic appearance.

## PRODUCT SPECIFICATIONS



**LARGE RECTANGLE**  
 $8\frac{7}{8} \times 13\frac{1}{4} \times 3\frac{1}{8}$ "  
 225 x 338 x 80mm



**SQUARE**  
 $8\frac{7}{8} \times 8\frac{7}{8} \times 3\frac{1}{8}$ "  
 225 x 225 x 80mm



**SMALL RECTANGLE**  
 $4\frac{1}{2} \times 8\frac{7}{8} \times 3\frac{1}{8}$ "  
 112 x 225 x 80mm

3 UNIT RANDOM BUNDLE

## EDGE DETAILS



ROUNDED EDGE

## BUNDLE CONFIGURATION



\*Colour selection should be chosen from actual samples.

**TECHNICAL INFORMATION**

**ASTM C 936 Standard Specifications for Solid Concrete Interlocking Paving Units**

- Conforms to:
- C140 for Absorption 5% avg - 7% max
  - Compressive Strength > 7,200 PSI avg.
  - C67 for Freeze-thaw Durability
  - C418 for Abrasion Durability
  - Dimensional Accuracy **+/- 3mm**
- Test results available upon request*

**Meets the U.S. Architectural & Transportation Barrier Compliance Board Slip-Resistance Surfaces Advisory Guidelines**

**LEED INFORMATION**

**Materials & Resources: LEED V4:**

- Building Product Disclosure and Optimization
- Sourcing of Raw Materials - Sourcing of Raw Materials and Extraction • **1 point**
- Sourcing of Raw Materials - Leadership Extraction Practices • **1 point**
- Material Ingredient Reporting - Material Ingredient Reporting • **1 point**
- Material Ingredient Reporting - Material Ingredient Optimization • **1 point**
- Environmental Product Declaration • **1 point**

**TECHNICAL ADVANTAGES**

**CLASSIC**

Budget-friendly. Utilizes a traditional product mix of large and small aggregates that's consistent from top to bottom with colour mixed throughout



**PERMEABLE**

Can be installed to allow water to flow through

**DRIVE FRIENDLY**

Can handle vehicular loads  
*Ask about our base stabilization system*

**PRODUCT DATA**

Stones & Bundling	Unit Thickness	SqFt Per				Per Bundle		Soldier LnFt Per			Sailor LnFt per			Units Per		Lbs Per		
		Bundle	Layer	Section	Stone	Layers	Section	Unit	Section	Bundle	Unit	Layer	Bundle	SqFt	Bundle	Layer	Section	Bundle
<b>Ayr Manufacturing</b>																		
Random Bundle		93.50	11.69	-	-	8	-	-	-	-	-	-	146.77	1.80	168	427.63	-	3,421
Large Rectangle	3 1/2" (80mm)	39.36	5.26	-	0.82	8	-	-	-	-	1.11	-	53.22	0.48	48	192.45	-	1,539.64
Square	3 1/2" (80mm)	30.80	4.09	-	0.55	8	-	-	-	-	0.74	-	41.33	0.72	56	149.69	-	1,197.50
Small Rectangle	3 1/2" (80mm)	17.28	2.34	-	0.27	8	-	-	-	-	0.37	-	23.49	1.43	64	85.54	-	684.29

Notes: Sold in full bundles only on a refundable skid. All measurements are nominal. **Important: A urethane rubber paver mat must be used to prevent scuffing.** For more information, samples or custom options, please contact your Unilock Territory Manager or call 1-800-UNILOCK.

**APPLICATIONS**



Pedestrian



Residential Vehicular



Commercial Vehicular



\*Wall pairing suggestion- U-CARA - matching colour and finish

**RECOMMENDED SANDS**

**RECOMMENDED SEALER**



**Romex: Rompox<sup>®</sup> ECO-Fine**

**Pedestrian Applications only**  
**Vehicular when laid on a Trass Bed**

- Ready mixed and easy to use
- Resin film free
- Resistant to ants, weeds, de-icing salts
- Made from 98% natural, recycled or renewable raw materials
- Pressure washer safe
- Ideal for joint widths from 5 mm (1/4")

**Coverage:**

Colour	5-6mm Joints
Beige, Stone Grey, Anthracite <i>55 lb bag / 1 kg can</i>	125 sqft / 55 lb mix



**Romex: Rompox<sup>®</sup> D1**

**Heavy Duty Vehicular Applications**

- Light to medium vehicle rated
- Increased pouring capacity that is self-compacting and water emulsifiable
- Resistant to ants, weeds, de-icing salts
- Pressure washer safe
- Ideal for joint widths from 3mm (1/8")
- Ideal for driveways, parking spaces and all vehicular loading applications up to 7.5 T
- Three colours: Neutral, Stone Grey and Basalt

**Coverage:**

Colour	6mm Joints
Neutral, Stone Grey, Basalt <i>Two 1.5 L bottles to be mixed with one 55 lb bag of Romex approved sand</i>	25 sqft / 55 lb mix <i>(based on 1,000 sqft)</i>



**Alliance Gator G2 MAXX Sand**

- Rain safe after 15 minutes (24hr no rain if concrete overlay)
- Sets above 32° F/ 0° C - may vary depending on weather, drainage, bedding materials and installation
- Dust free and haze free
- Requires only one watering
- Four colours: Beige, Grey, Black and Ivory

**Coverage:**

Colour	Narrow Joints	Wide Joints
Beige, Grey, Ivory <i>50 lb bag</i>	65-85 sqft	22-42 sqft
Black <i>50 lb bag</i>	58-76 sqft	20-38 sqft



**Alliance Gator Natural Look Sealer**

- Water-based
- Zero gloss finish
- Multi purpose
- Rain safe after 24 hours

**Coverage:**

Size	Area
3.78 L / 1 U.S. gal.	175 sqft
18.9 L / 5.28 U.S. gal.	875 sqft

\*Please refer to Sands & Sealers on pages 190-202 for more detailed information.

Unsure of bonded vs. unbonded product recommendations? Please contact your Unilock Territory Manager for more information.



# TRIBECA COBBLE™

ENDURACOLOR™ PERMEABLE



CRYSTALLINE BASALT



PEPPERED GRANITE

## VISUAL APPEARANCE

Tribeca Cobble™ pavers are exemplary of the beautiful imported granite cobble stones used in North America's streets for centuries.

## FINISH

Granite, Quartz and Marble surface materials.

## PRODUCT SPECIFICATIONS



**LARGE RECTANGLE**  
5 1/8" x 12" x 2 3/4"  
130 x 305 x 70mm



**RECTANGLE**  
5 1/8" x 9" x 2 3/4"  
130 x 230 x 70mm



**SMALL RECTANGLE**  
5 1/8" x 7" x 2 3/4"  
130 x 175 x 70mm

3 UNIT RANDOM BUNDLE

## EDGE DETAILS



ROUNDED EDGE

## LAYER CONFIGURATION



## LAYING PATTERNS

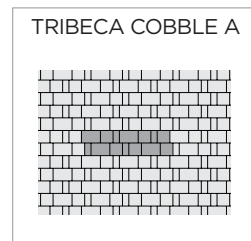

TRIBECA COBBLE A  
100% Standard

## PERMEABLE PAVEMENT DATA

					MIN. INFILTRATION RATE FOR RAINFALL OF:			
Extra Large: > 1/2" Joint	JOINT MATERIAL	JOINT WIDTH*	VOID SPACE*	SURFACE INFILTRATION RATE**	2" / HR	4.5" / HR	6.5" / HR	11" / HR
			10mm	5.6%	400" / HR	36	80	116

\*Joint Width is measured at the top of the paver. Void Space is calculated at the base of the paver. \*\*Infiltration rate is based on testing done when first installed and is an approximate. Permeable spacers are available for use with extended range of Unilock products.

\*Colour selection should be chosen from actual samples.



**TECHNICAL INFORMATION**

**ASTM C936 Standard Specifications for Solid Concrete Interlocking Paving Units**

Conforms to:

- C140 for Absorption 5% avg - 7% max
- Compressive Strength > 7,200 PSI avg.
- C67 for Freeze-thaw Durability
- C418 for Abrasion Durability
- Dimensional Accuracy **+/- 3 mm**

Test results available upon request

**Meets the U.S. Architectural & Transportation Barrier Compliance Board Slip-Resistance Surfaces Advisory Guidelines**

**LEED INFORMATION**

**Materials & Resources: LEED V4:**

- Building Product Disclosure and Optimization
- Sourcing of Raw Materials - Sourcing of Raw Materials and Extraction • **1 point**
- Sourcing of Raw Materials - Leadership Extraction Practices • **1 point**
- Material Ingredient Reporting - Material Ingredient Reporting • **1 point**
- Material Ingredient Reporting - Material Ingredient Optimization • **1 point**
- Environmental Product Declaration • **1 point**

**TECHNICAL ADVANTAGES**

**ENDURACOLOR™**

Refined surface and long-lasting colour



**PERMEABLE**

Can be installed to allow water to flow through

**DRIVE FRIENDLY**

Can handle vehicular loads

Ask about our base stabilization system

**PRODUCT DATA**

Stones & Bundling	Unit Thickness	SqFt Per			Per Bundle		Soldier LnFt Per			Sailor LnFt per			Units Per			Lbs Per		
		Bundle	Layer	Stone	Layers	Sections	Unit	Section	Bundle	Unit	Section	Bundle	SqFt	Layer	Bundle	Unit	Layer	Bundle
<b>Stocked in Ayr</b>																		
Random Bundle		97.53	12.19	0.32	8	-	-	-	-	2.34	-	227.95	3.12	38	304	-	398.21	3,185.67
Large Rectangle	2¾" (70mm)	-	-	0.43	-	-	-	-	-	1.00	-	88.10	2.34	-	88	-	-	-
Rectangle	2¾" (70mm)	-	-	0.32	-	-	-	-	-	0.75	-	66.40	3.11	-	88	-	-	-
Small Rectangle	2¾" (70mm)	-	-	0.25	-	-	-	-	-	0.57	-	73.50	4.08	-	128	-	-	-

Notes: **Sold in full bundles only.** All measurements are nominal. **Important: A urethane rubber paver mat must be used to prevent scuffing.** For more information, samples or custom options, please contact your Unilock Territory Manager or call 1-800-UNILOCK.

**APPLICATIONS**

Pedestrian    
 Residential Vehicular    
 Commercial Vehicular    
 Permeable

Borders and Accents    
 \*Wall pairing suggestion- U-Cara® Wall

RECOMMENDED SANDS				RECOMMENDED SEALER																										
<p><b>Romex: Rompox® ECO-Fine</b> Pedestrian Applications only Vehicular when laid on a Trass Bed</p> <ul style="list-style-type: none"> <li>Ready mixed and easy to use</li> <li>Resin film free</li> <li>Resistant to ants, weeds, de-icing salts</li> <li>Made from 98% natural, recycled or renewable raw materials</li> <li>Pressure washer safe</li> <li>Ideal for joint widths from 5mm (1/4")</li> </ul> <p>Coverage:</p> <table border="1"> <tr> <th>Colour</th> <th>5-6mm Joints</th> </tr> <tr> <td>Beige, Stone Grey, Anthracite 55 lb bag / 1 kg can</td> <td>125 sqft / 55 lb mix</td> </tr> </table>		Colour	5-6mm Joints	Beige, Stone Grey, Anthracite 55 lb bag / 1 kg can	125 sqft / 55 lb mix	<p><b>Romex: Rompox® Drain</b> Vehicular Applications</p> <ul style="list-style-type: none"> <li>Resin film-free</li> <li>Highly water permeable</li> <li>Self-compacting and water emulsifiable</li> <li>Resistant to ants, weeds, de-icing salts</li> <li>Pressure washer safe</li> <li>Ideal for joint widths from 3mm (1/4")</li> <li>Ideal for driveways, parking spaces and all vehicular loading applications up to 3.5 T</li> <li>Three colours: Neutral, Stone Grey and Basalt</li> </ul> <p>Coverage:</p> <table border="1"> <tr> <th>Colour</th> <th>6mm Joints</th> </tr> <tr> <td>Neutral, Stone Grey, Basalt Two 1 L bottles to be mixed with one 55 lb bag of Romex approved sand</td> <td>25 sqft / 55 lb mix (based on 1,000 sqft)</td> </tr> </table>		Colour	6mm Joints	Neutral, Stone Grey, Basalt Two 1 L bottles to be mixed with one 55 lb bag of Romex approved sand	25 sqft / 55 lb mix (based on 1,000 sqft)	<p><b>Alliance Gator G2 MAXX Sand</b></p> <ul style="list-style-type: none"> <li>Rain safe after 15 minutes (24hr no rain if concrete overlay)</li> <li>Sets above 32° F/ 0° C - may vary depending on weather, drainage, bedding materials and installation</li> <li>Dust free and haze free</li> <li>Requires only one watering</li> <li>Four colours: Beige, Grey, Black and Ivory</li> </ul> <p>Coverage:</p> <table border="1"> <tr> <th>Colour</th> <th>Narrow Joints</th> <th>Wide Joints</th> </tr> <tr> <td>Beige, Grey, Ivory 50 lb bag</td> <td>65-85 sqft</td> <td>22-42 sqft</td> </tr> <tr> <td>Black 50 lb bag</td> <td>58-76 sqft</td> <td>20-38 sqft</td> </tr> </table>		Colour	Narrow Joints	Wide Joints	Beige, Grey, Ivory 50 lb bag	65-85 sqft	22-42 sqft	Black 50 lb bag	58-76 sqft	20-38 sqft	<p><b>Alliance Gator Natural Look Sealer</b></p> <ul style="list-style-type: none"> <li>Water-based</li> <li>Zero gloss finish</li> <li>Multi purpose</li> <li>Rain safe after 24 hours</li> </ul> <p>Coverage:</p> <table border="1"> <tr> <th>Size</th> <th>Area</th> </tr> <tr> <td>3.78 L / 1 U.S. gal.</td> <td>175 sqft</td> </tr> <tr> <td>18.9 L / 5.28 U.S. gal.</td> <td>875 sqft</td> </tr> </table>		Size	Area	3.78 L / 1 U.S. gal.	175 sqft	18.9 L / 5.28 U.S. gal.	875 sqft
Colour	5-6mm Joints																													
Beige, Stone Grey, Anthracite 55 lb bag / 1 kg can	125 sqft / 55 lb mix																													
Colour	6mm Joints																													
Neutral, Stone Grey, Basalt Two 1 L bottles to be mixed with one 55 lb bag of Romex approved sand	25 sqft / 55 lb mix (based on 1,000 sqft)																													
Colour	Narrow Joints	Wide Joints																												
Beige, Grey, Ivory 50 lb bag	65-85 sqft	22-42 sqft																												
Black 50 lb bag	58-76 sqft	20-38 sqft																												
Size	Area																													
3.78 L / 1 U.S. gal.	175 sqft																													
18.9 L / 5.28 U.S. gal.	875 sqft																													

\*Please refer to Sands & Sealers on pages 190-202 for more detailed information.

Unsure of bonded vs. unbonded product recommendations? Please contact your Unilock Territory Manager for more information.

# TURFSTONE™

 PERMEABLE

*\*Special Order only*

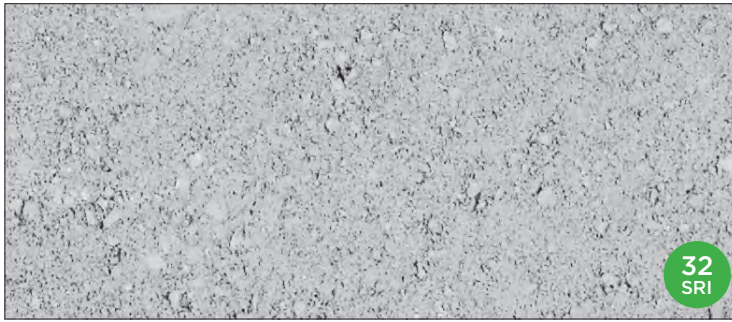

NATURAL



## VISUAL APPEARANCE

Its filigree design makes it an attractive and permanent solution for emergency access areas, embankments, spillways, and environmentally sensitive parking areas.

## FINISH

Classic Finish. Turfstone has the option of being filled with grass or aggregates depending on the project's drainage requirements.

## PRODUCT SPECIFICATIONS



**STANDARD**  
16 x 24 x 3 1/8"  
400 x 600 x 80mm

## EDGE DETAILS

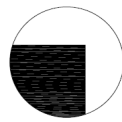

ZERO-BEVEL EDGE

## LAYING PATTERNS

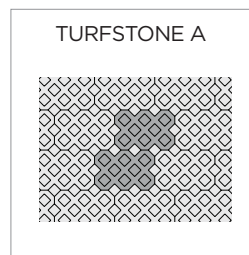

## DRIVECEL

- Creates a revolutionary Reinforced Soil Structure (RSS) with high tensile and compressive strength to maximize the performance of pavement structures.
- Extremely permeable, long lasting, durable and environmentally friendly. Lightweight and easy to handle.
- Simple and quick installation.
- Allows for easy repairs / adjustments after installation.

See page 186-187 for more details.

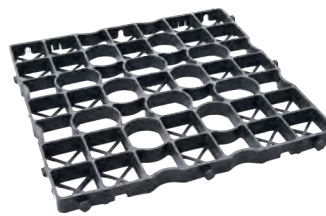

**DRIVECEL30 LIGHT DUTY**  
20 x 20 x 1.2"  
500 x 500 x 30mm

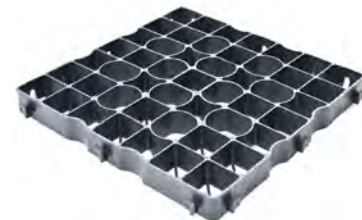

**DRIVECEL50 HEAVY DUTY**  
20 x 20 x 2"  
500 x 500 x 50mm

\*Colour selection should be chosen from actual samples.

**TECHNICAL INFORMATION**

**ASTM C936 Standard Specifications for Solid Concrete Interlocking Paving Units**

Conforms to:

- C140 for Absorption 5% avg - 7% max
- Compressive Strength > 7,200 PSI avg.
- C67 for Freeze-thaw Durability
- C418 for Abrasion Durability
- Dimensional Accuracy **+/- 3 mm**

*Test results available upon request*

**Meets the U.S. Architectural & Transportation Barrier Compliance Board Slip-Resistance Surfaces Advisory Guidelines**

**Void Space:** 40%

**Load Capacity:** Turfstone is capable of supporting H<sub>2</sub>O loading over a properly designed and compacted base.

**SOLAR REFLECTIVE INDEX (SRI) TESTING DETAILS**

Product	Solar Reflectance	SRI
Natural	0.30	32 

**LEED INFORMATION**

**Rainwater Management: LEED V4:**

- Up to 3 points can be achieved for retaining rainwater onsite based on the percentile kept
- 85% (zero lot line projects only) - 3 points, 95% - 2 points and 98% - 3 points. (All except Healthcare - subtract one point) See LEED v4 for more specific project/site details.

**Materials and Resources: LEED V4:**

- Building Product Disclosure and Optimization
- Sourcing of Raw Materials - Sourcing of Raw Materials and Extraction • **1 point**
- Sourcing of Raw Materials - Leadership Extraction Practices • **1 point**
- Material Ingredient Reporting - Material Ingredient Reporting • **1 point**
- Material Ingredient Reporting - Material Ingredient Optimization • **1 point**
- Environmental Product Declaration • **1 point**

**TECHNICAL ADVANTAGES**

 **PERMEABLE**

Can be installed to allow water to flow through

**PRODUCT DATA**

Stones & Bundling	Unit	SqFt Per				Per Bundle		Soldier LnFt Per			Sailor LnFt per			Units Per			Lbs Per		
	Thickness	Bundle	Layer	Section	Stone	Layers	Sections	Unit	Section	Bundle	Unit	Section	Bundle	SqFt	Section	Bundle	Layer	Section	Bundle
<b>Ayr / Gormley Manufacturing</b>																			
Standard	3 1/8" (80mm)	60.00	7.50	-	2.50	8	-	-	-	-	-	-	-	0.40	-	24	187	-	1,499

Notes: **Special Order item.** Lead time required. Sold in full bundles only on a refundable skid. All measurements are nominal. For more information, samples or custom options, please contact your Unilock Territory Manager or call 1-800-UNILOCK.

**APPLICATIONS**

 Permeable

\*Turfstone™ is typically used in erosion control situations. Also known to be used in areas where emergency access routes are required.

**RECOMMENDED SANDS**



**Romex: Rompox® Profi-Deko**

- | For Residential & Commercial applications
- | For permeable paver joints
- | Helps prevent gravel displacement and reduces maintenance
- | Strong and visually appealing
- | Graded to meet ASTM No. 9 water rate
- | Perfect for pathways, tree pits and decorative gravel areas
- | Resistant to ants, weeds, frost, de-icing salt and is pressure washer safe

**Coverage:**

Size	Area
1L bottle + One 2L bottle <i>(to be mixed with chosen aggregate)</i>	20-25 sqft



**Alliance Gator Aqua Rock**

- | For Residential & Commercial applications
- | For permeable paver joints
- | Helps prevent erosion due to climatic conditions
- | Use as bedding and jointing material
- | Graded to meet ASTM No. 9 water rate
- | Long term high infiltration performance
- | 2,200 lb Super Sack available for large applications

**Coverage:**

Size	Area
50 lb bag	20-25 sqft
2,200 lb Super Sack	880-1100 sqft

\*Please refer to Sands & Sealers on pages 190-202 for more detailed information.

Unsure of bonded vs. unbonded product recommendations? Please contact your Unilock Territory Manager for more information.

# UMBRIANO<sup>®</sup> 60mm

Exclusive to **JNIOLOCK**



**ENDURACOLOR™**



FRENCH GREY

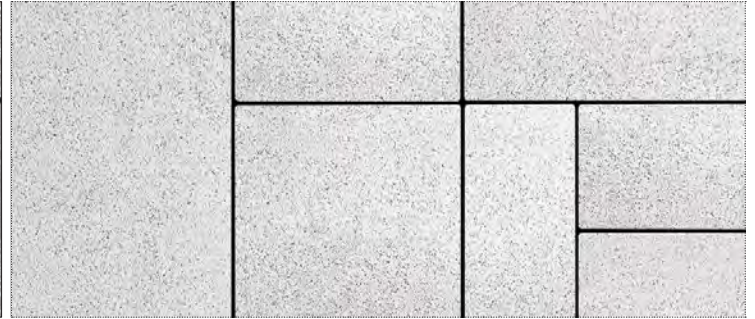

GRENADA WHITE



SUMMER WHEAT

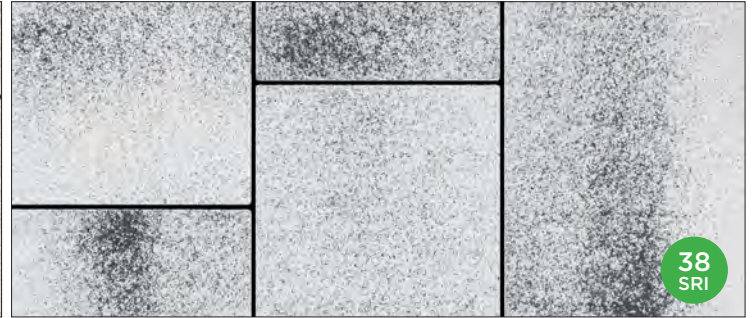

WINTER MARVEL

## VISUAL APPEARANCE

Granite-like surface appearance.

## FINISH

Subtly mottled colour and finish. Factory sealed to provide integral surface protection from stains.

## PRODUCT SPECIFICATIONS



### LARGE RECTANGLE

14 x 21 x 2<sup>3</sup>/<sub>8</sub>"  
360 x 540 x 60mm



### SQUARE

14 x 14 x 2<sup>3</sup>/<sub>8</sub>"  
360 x 360 x 60mm



### SMALL RECTANGLE

7 x 14 x 2<sup>3</sup>/<sub>8</sub>"  
180 x 360 x 60mm

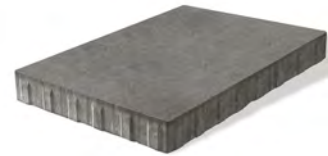

### SLAB

21 x 35 x 2<sup>3</sup>/<sub>8</sub>"  
540 x 890 x 60mm

See Slabs section page 106  
for more details

3 UNIT RANDOM BUNDLE

## EDGE DETAILS



ZERO BEVEL EDGE

## BUNDLE CONFIGURATION

UMBRIANO  
RANDOM BUNDLE

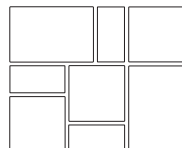

## LAYING PATTERNS

UMBRIANO  
RANDOM BUNDLE B

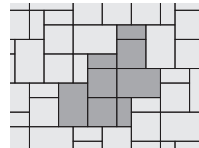

\*Colour selection should be chosen from actual samples.

**TECHNICAL INFORMATION**

**ASTM C936 Standard Specifications for Solid Concrete Interlocking Paving Units**





Conforms to:

- C140 for Absorption 5% avg - 7% max
- Compressive Strength > 7,200 PSI avg.
- C67 for Freeze-thaw Durability
- C418 for Abrasion Durability
- Dimensional Accuracy **+/- 3 mm**

Test results available upon request

**Meets the U.S. Architectural & Transportation Barrier Compliance Board Slip-Resistance Surfaces Advisory Guidelines**

**SOLAR REFLECTIVE INDEX (SRI) TESTING DETAILS**

Product	Solar Reflectance	SRI
Cream (custom)	0.45	52 
Grenada White	0.45	52 
Summer Wheat	0.42	48 
Winter Marvel	0.35	38 

**TECHNICAL ADVANTAGES**

**ENDURACOLOR™**

Refined surface and long-lasting colour



Factory sealed for integral stain resistance

**COLORFUSION™**

Subtly mottled colour finish

**PEDESTRIAN FRIENDLY**

Not recommended for vehicular loads

**LEED INFORMATION**

**Rainwater Management: LEED V4:**

- Up to three points can be achieved for retaining rainwater onsite based on the percentile kept
- 85% (zero lot line projects only) - 3 points, 95% - 2 points and 98% - 3 points. (All except Healthcare - subtract one point) See LEED v4 for more specific project/site details.

**Materials and Resources: LEED V4:**

- Building Product Disclosure and Optimization
- Sourcing of Raw Materials - Sourcing of Raw Materials and Extraction • **1 point**
- Sourcing of Raw Materials - Leadership Extraction Practices • **1 point**
- Material Ingredient Reporting - Material Ingredient Reporting • **1 point**
- Material Ingredient Reporting - Material Ingredient Optimization • **1 point**
- Environmental Product Declaration • **1 point**

**PRODUCT DATA**

Stones & Bundling	Unit Thickness	SqFt Per				Per Bundle		Sailor LnFt Per			Units Per		Lbs Per			
		Bundle	Layer	Section	Stone	Layers	Sections	Unit	Section	Bundle	SqFt	Section	Bundle	Layer	Section	Bundle
<b>Georgetown Manufacturing</b>																
Random Bundle 60mm		94.14	10.46	-	-	9	-	1.36	-	79.70	0.76	-	72	287	-	2,584
Large Rectangle 14 x 21 x 2 3/8"	2 3/8" (60mm)	-	-	-	2.09	-	-	1.77	-	31.80	0.48	-	18	-	-	-
Square 14 x 14 x 2 3/8"	2 3/8" (60mm)	-	-	-	1.40	-	-	1.18	-	31.80	0.72	-	27	-	-	-
Small Rectangle 7 x 14 x 2 3/8"	2 3/8" (60mm)	-	-	-	0.70	-	-	0.59	-	15.90	1.43	-	27	-	-	-

Notes: 60mm Random products are not intended for vehicular applications. All measurements are nominal. **Sold in full bundles only** on a refundable skid. **Important: A urethane rubber paver mat must be used to prevent scuffing.** For more information, samples or custom options, please contact your Unilock Territory Manager or call 1-800-UNILOCK.

**APPLICATIONS**



Pedestrian



Roof Deck



Borders and Accents



\*Wall pairing suggestion- U-CARA® - matching colour and finish

**RECOMMENDED SANDS**

**RECOMMENDED SEALER**



**Romex: Rompox® ECO-Fine**  
Pedestrian Applications only  
Vehicular when laid on a Trass Bed

- | Ready mixed and easy to use
- | Resin film free
- | Resistant to ants, weeds, de-icing salts
- | Made from 98% natural, recycled or renewable raw materials
- | Pressure washer safe
- | Ideal for joint widths from 5mm (1/4")

**Coverage:**

Colour	5-6mm Joints
Beige, Stone Grey, Anthracite 55 lb bag / 1 kg can	125 sqft / 55 lb mix



**Alliance Gator G2 MAXX Sand**

- | Rain safe after 15 minutes (24hr no rain if concrete overlay)
- | Sets above 32° F/ 0° C - may vary depending on weather, drainage, bedding materials and installation
- | Dust free and haze free
- | Requires only one watering
- | Four colours: Beige, Grey, Black and Ivory

**Coverage:**

Colour	Narrow Joints	Wide Joints
Beige, Grey, Ivory 50 lb bag	65-85 sqft	22-42 sqft
Black 50 lb bag	58-76 sqft	20-38 sqft



**Alliance Gator Hybrid Low Gloss + Colour Enhancer**

- | Water-based
- | Low gloss finish
- | Vibrant Colour Enhancer
- | Rain safe after 24 hours

**Coverage:**

Size	Area
3.78 L / 1 U.S. gal.	200 sqft
18.9 L / 5.28 U.S. gal.	1000 sqft

\*Please refer to Sands & Sealers on pages 190-202 for more detailed information.

Unsure of bonded vs. unbonded product recommendations? Please contact your Unilock Territory Manager for more information.

# UMBRIANO<sup>®</sup> 70mm

Exclusive to **JNIOLOCK**



**ENDURACOLOR™**



FRENCH GREY

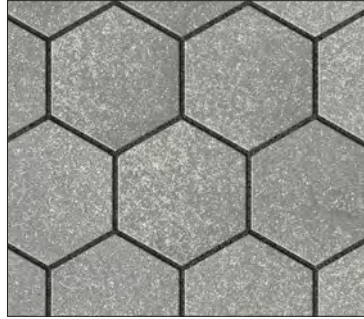

MIDNIGHT SKY

ONLY AVAILABLE IN 8 x 16 & 8 x 24



SUMMER WHEAT

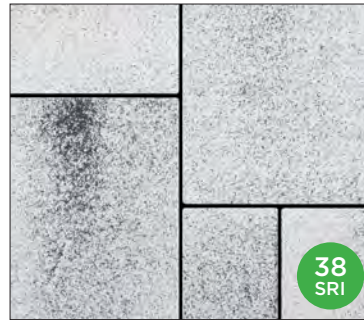

WINTER MARVEL

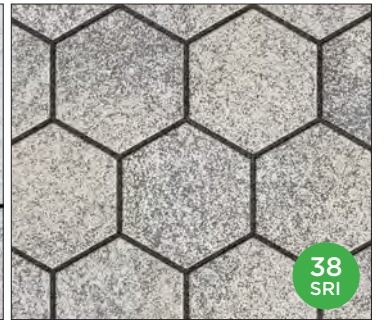

## VISUAL APPEARANCE

Granite-like surface appearance.

## FINISH

Subtly mottled colour and finish. Factory sealed to provide integral surface protection from stains

## PRODUCT SPECIFICATIONS



24 x 24 x 2<sup>3</sup>/<sub>4</sub>"  
600 x 600 x 70mm  
*Special Order only*



12 x 24 x 2<sup>3</sup>/<sub>4</sub>"  
300 x 600 x 70mm



8 x 24 x 2<sup>3</sup>/<sub>4</sub>"  
200 x 600 x 70mm



8 x 16 x 2<sup>3</sup>/<sub>4</sub>"  
200 x 400 x 70mm



16 x 16 x 2<sup>3</sup>/<sub>4</sub>"  
400 x 400 x 70mm

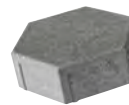

HEX  
8 x 8 x 2<sup>3</sup>/<sub>4</sub>"  
200 x 200 x 70mm

## EDGE DETAILS



ZERO BEVEL EDGE

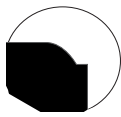

BEVELLED EDGE  
*\*Hex Shape only*

\*Colour selection should be chosen from actual samples.



## BUNDLE CONFIGURATION

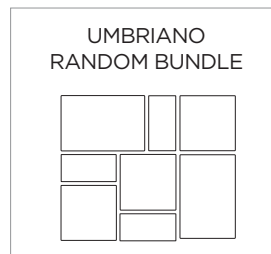

## LAYING PATTERNS

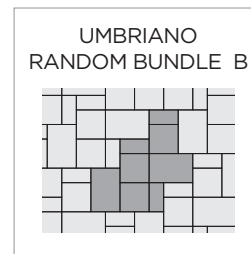

TECHNICAL INFORMATION

ASTM C936 Standard Specifications for Solid Concrete Interlocking Paving Units



Conforms to:

- C140 for Absorption 5% avg - 7% max
- Compressive Strength > 7,200 PSI avg.
- C67 for Freeze-thaw Durability
- C418 for Abrasion Durability
- Dimensional Accuracy +/- 3 mm

Test results available upon request

Meets the U.S. Architectural & Transportation Barrier Compliance Board Slip-Resistance Surfaces Advisory Guidelines

SOLAR REFLECTIVE INDEX (SRI) TESTING DETAILS

Product	Solar Reflectance	SRI
Cream (custom)	0.45	52 
Summer Wheat	0.42	48 
Winter Marvel	0.35	38 

TECHNICAL ADVANTAGES

ENDURACOLOR™

Refined surface and long-lasting colour



Factory sealed for integral stain resistance

COLORFUSION™

Subtly mottled colour finish

DRIVE FRIENDLY

24" Slabs **not** recommended for vehicular loads

All other sizes can handle vehicular loads

Ask about our base stabilization system

LEED INFORMATION

Rainwater Management: LEED V4:

- Up to three points can be achieved for retaining rainwater onsite based on the percentile kept
- 85% (zero lot line projects only) - 3 points, 95% - 2 points and 98% - 3 points. (All except Healthcare - subtract one point) See LEED v4 for more specific project/site details.

Materials and Resources: LEED V4:

- Building Product Disclosure and Optimization
- Sourcing of Raw Materials - Sourcing of Raw Materials and Extraction • 1 point
- Sourcing of Raw Materials - Leadership Extraction Practices • 1 point
- Material Ingredient Reporting - Material Ingredient Reporting • 1 point
- Material Ingredient Reporting - Material Ingredient Optimization • 1 point
- Environmental Product Declaration • 1 point

PRODUCT DATA

Stones & Bundling	Unit	SqFt Per			Per Bundle		Soldier LnFt Per			Sailor LnFt per			Units Per		Lbs Per				
	Thickness	Bundle	Layer	Section	Stone	Layers	Sections	Unit	Section	Bundle	Unit	Section	Bundle	SqFt	Section	Bundle	Layer	Section	Bundle
<b>Georgetown Manufacturing</b>																			
24 x 24	2¾" (70mm)	62.00	7.75	-	3.88	8	-	1.97	-	31.50	1.97	-	31.50	0.26	-	16	258	-	2,062
12 x 24	2¾" (70mm)	93.00	11.63	-	1.94	8	-	0.98	-	47.20	1.97	-	94.50	0.52	-	48	393	-	3,142
16 x 16"	2¾" (70mm)	82.67	10.33	-	1.72	8	-	1.31	-	63.00	1.31	-	63.00	0.58	-	48	350	-	2,797
8" x 16"	2¾" (70mm)	82.67	10.33	-	0.86	8	-	0.66	-	63.00	1.31	-	126.00	1.16	-	96	343	-	2,746
8" x 24"	2¾" (70mm)	82.67	10.33	-	1.29	8	-	0.66	-	42.00	1.97	-	83.99	0.77	-	64	331	-	2,647
HEX 8 x 8	2¾" (70mm)	73.92	9.24	-	0.39	8	-	-	-	-	-	-	-	2.60	-	192	306	-	2,450

Notes: 24" products are not intended for vehicular applications. All measurements are nominal. Sold in full bundles only on a refundable skid. Important: A urethane rubber paver mat must be used to prevent scuffing. For more information, samples or custom options, please contact your Unilock Territory Manager or call 1-800-UNILOCK.

APPLICATIONS



Pedestrian



Residential Vehicular (24" Slabs not recommended for vehicular loads)



Commercial Vehicular (Hex only) (24" Slabs not recommended for vehicular loads)



Roof Deck



Borders and Accents



\*Wall pairing suggestion- U-CARA\* - matching colour and finish

RECOMMENDED SANDS

RECOMMENDED SEALER



+



**Romex: Rompox® Fugensand**  
Pedestrian, Vehicular and Heavy Duty Vehicular Applications

- Manufactured from natural, raw materials
- Quick application
- Self-repairing properties
- Suitable for all load classes
- No cement haze/residue due to natural polymer binder
- Three colours: Natural, Stone Grey and Basalt

Coverage:

Colour	3mm Joints
Neutral, Stone Grey, Basalt 1 L / 5 gal	110 sqft / 55 lb bag 750 sqft / 5 gal drum

**Romex: Rompox® D7000 Joint Strengthener & Surface Sealer**  
Pedestrian, Vehicular and Heavy Duty Vehicular Applications

- All-in-one strengthener & sealer
- Eco-Friendly
- Protects against dirt, oil, corrosion from climate exposure, de-icing salts
- Protects against weed growth and wash outs

Coverage:

Colour	3mm Joints
Neutral, Stone Grey, Basalt 55 lb bag / 1 kg can	110 sqft / 55 lb bag 750 sqft / 5 gal drum

**Alliance Gator G2 MAXX Sand**

- Rain safe after 15 minutes (24hr no rain if concrete overlay)
- Sets above 32° F/ 0° C - may vary depending on weather, drainage, bedding materials and installation
- Dust free and haze free
- Requires only one watering
- Four colours: Beige, Grey, Black and Ivory

Coverage:

Colour	Narrow Joints	Wide Joints
Beige, Grey, Ivory 50 lb bag	65-85 sqft	22-42 sqft
Black 50 lb bag	58-76 sqft	20-38 sqft

**Alliance Gator Hybrid Low Gloss + Colour Enhancer**

- Water-based
- Low gloss finish
- Vibrant Colour Enhancer
- Rain safe after 24 hours

Coverage:

Size	Area
3.78 L / 1 U.S. gal.	200 sqft
18.9 L / 5.28 U.S. gal.	1000 sqft

\*Please refer to Sands & Sealers on pages 190-202 for more detailed information.

Unsure of bonded vs. unbonded product recommendations? Please contact your Unilock Territory Manager for more information.



# UMBRIANO<sup>®</sup> 80mm

Exclusive to **UNILOCK**



**ENDURACOLOR™**

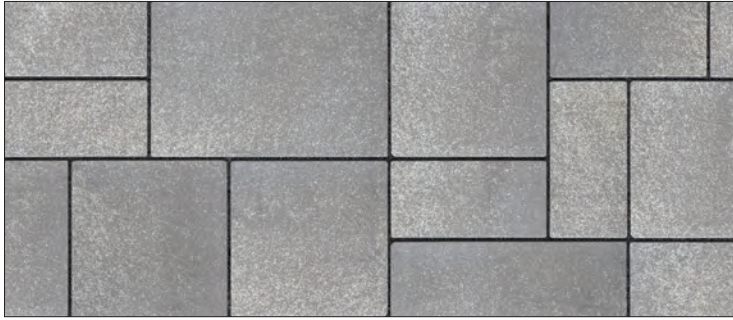

FRENCH GREY



SUMMER WHEAT

48  
SRI



WINTER MARVEL

38  
SRI

## VISUAL APPEARANCE

Granite-like surface appearance.

## FINISH

Subtly mottled colour and finish. Factory sealed to provide integral surface protection from stains.

## PRODUCT SPECIFICATIONS



**LARGE RECTANGLE**  
14 x 21 x 3/8"  
360 x 540 x 80mm



**SQUARE**  
14 x 14 x 3/8"  
360 x 360 x 80mm



**SMALL RECTANGLE**  
7 x 14 x 3/8"  
180 x 360 x 80mm



**SMALL RECTANGLE**  
7 x 14 x 3/8"  
180 x 360 x 80mm

3 UNIT RANDOM BUNDLE

## EDGE DETAILS



ZERO BEVEL EDGE

## BUNDLE CONFIGURATION

UMBRIANO  
RANDOM BUNDLE

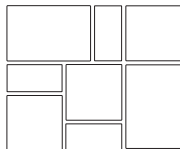

## LAYING PATTERNS

UMBRIANO  
RANDOM BUNDLE B

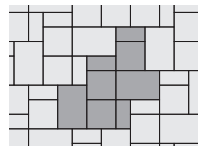

\*Colour selection should be chosen from actual samples.



**TECHNICAL INFORMATION**

**ASTM C936 Standard Specifications for Solid Concrete Interlocking Paving Units**

- Conforms to:
- C140 for Absorption 5% avg - 7% max
  - Compressive Strength > 7,200 PSI avg.
  - C67 for Freeze-thaw Durability
  - C418 for Abrasion Durability
  - Dimensional Accuracy **+/- 3 mm**
- Test results available upon request*

**Meets the U.S. Architectural & Transportation Barrier Compliance Board Slip-Resistance Surfaces Advisory Guidelines**

**SOLAR REFLECTIVE INDEX (SRI) TESTING DETAILS**

Product	Solar Reflectance	SRI
Cream (custom)	0.45	52
Summer Wheat	0.42	48
Winter Marvel	0.35	38

**TECHNICAL ADVANTAGES**

**ENDURACOLOR™**

Refined surface and long-lasting colour



Factory sealed for integral stain resistance

**COLORFUSION™**

Subtly mottled colour finish

**DRIVE FRIENDLY**

Can handle vehicular loads  
*Ask about our base stabilization system*

**LEED INFORMATION**

**Rainwater Management: LEED V4:**

- Up to three points can be achieved for retaining rainwater onsite based on the percentile kept
- 85% (zero lot line projects only) - 3 points, 95% - 2 points and 98% - 3 points. (All except Healthcare - subtract one point) See LEED v4 for more specific project/site details.

**Materials and Resources: LEED V4:**

- Building Product Disclosure and Optimization
- Sourcing of Raw Materials - Sourcing of Raw Materials and Extraction • **1 point**
- Sourcing of Raw Materials - Leadership Extraction Practices • **1 point**
- Material Ingredient Reporting - Material Ingredient Reporting • **1 point**
- Material Ingredient Reporting - Material Ingredient Optimization • **1 point**
- Environmental Product Declaration • **1 point**

**PRODUCT DATA**

Stones & Bundling	Unit	SqFt Per				Per	Soldier LnFt Per			Sailor LnFt per			Units Per			Lbs Per		
	Thickness	Bundle	Layer	Section	Stone	Layers	Unit	Section	Bundle	Unit	Section	Bundle	SqFt	Section	Bundle	Layer	Section	Bundle
<b>Georgetown Manufacturing</b>																		
Random Bundle 80mm		73.22	10.46	-	-	7	-	-	-	0.99	-	62.00	0.77	-	56	383	-	2,680
Large Rectangle 14 x 21 x 3 3/8"	3 3/8" (80mm)	-	-	-	2.09	-	-	-	-	1.77	-	24.80	0.48	-	14	-	-	-
Square 14 x 14 x 3 3/8"	3 3/8" (80mm)	-	-	-	1.40	-	-	-	-	1.18	-	24.80	0.72	-	21	-	-	-
Small Rectangle 7 x 14 x 3 3/8"	3 3/8" (80mm)	-	-	-	0.70	-	-	-	-	0.59	-	12.40	1.43	-	21	-	-	-
7 x 14 x 3 3/8"	3 3/8" (80mm)	73.24	10.46	-	0.70	7	0.59	-	62.0	1.18	-	124.00	1.43	-	105	383	-	2,680

Notes: All measurements are nominal. **Sold in full bundles only** on a refundable skid. **Important: A urethane rubber paver mat must be used to prevent scuffing.** For more information, samples or custom options, please contact your Unilock Territory Manager or call 1-800-UNILOCK.

**APPLICATIONS**



Pedestrian



Residential Vehicular



\*Wall pairing suggestion- U-CARA\* - matching colour and finish

**RECOMMENDED SANDS**

**RECOMMENDED SEALER**



**Romex: Rompox® Fugensand**  
Pedestrian, Vehicular and Heavy Duty Vehicular Applications

- | Manufactured from natural, raw materials
- | Quick application
- | Self-repairing properties
- | Suitable for all load classes
- | No cement haze/residue due to natural polymer binder
- | Three colours: Natural, Stone Grey and Basalt

**Coverage:**

Colour	3mm Joints
Neutral, Stone Grey, Basalt 1 L / 5 gal	110 sqft / 55 lb bag 750 sqft / 5 gal drum

**Romex: Rompox® D7000 Joint Strengtheners & Surface Sealer**  
Pedestrian, Vehicular and Heavy Duty Vehicular Applications

- | All-in-one strengthener & sealer
- | Eco-Friendly
- | Protects against dirt, oil, corrosion from climate exposure, de-icing salts
- | Protects against weed growth and wash outs

**Coverage:**

Colour	3mm Joints
Neutral, Stone Grey, Basalt 55 lb bag / 1 kg can	110 sqft / 55 lb bag 750 sqft / 5 gal drum

**Alliance Gator G2 MAXX Sand**

- | Rain safe after 15 minutes (24hr no rain if concrete overlay)
- | Sets above 32° F/ 0° C - may vary depending on weather, drainage, bedding materials and installation
- | Dust free and haze free
- | Requires only one watering
- | Four colours: Beige, Grey, Black and Ivory

**Coverage:**

Colour	Narrow Joints	Wide Joints
Beige, Grey, Ivory 50 lb bag	65-85 sqft	22-42 sqft
Black 50 lb bag	58-76 sqft	20-38 sqft

**Alliance Gator Hybrid Low Gloss + Colour Enhancer**

- | Water-based
- | Low gloss finish
- | Vibrant Colour Enhancer
- | Rain safe after 24 hours

**Coverage:**

Size	Area
3.78 L / 1 U.S. gal.	200 sqft
18.9 L / 5.28 U.S. gal.	1,000 sqft

\*Please refer to Sands & Sealers on pages 190-202 for more detailed information.

Unsured of bonded vs. unbonded product recommendations? Please contact your Unilock Territory Manager for more information.



# UMBRIANO<sup>®</sup> 100mm

Exclusive to **UNILOCK**



**ENDURACOLOR™**

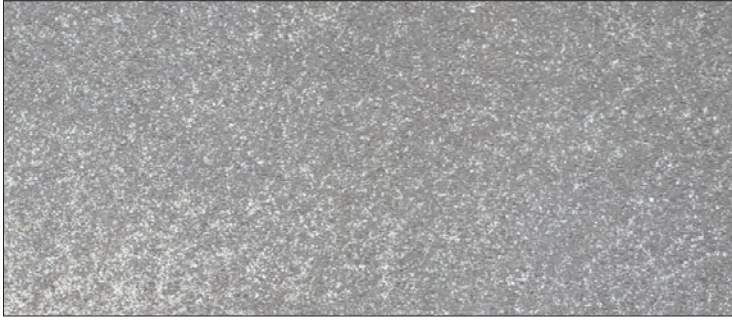

FRENCH GREY



SUMMER WHEAT

48  
SRI



WINTER MARVEL

38  
SRI

## VISUAL APPEARANCE

Granite-like surface appearance.

## FINISH

Subtly mottled colour and finish. Factory sealed to provide integral surface protection from stains.

## PRODUCT SPECIFICATIONS

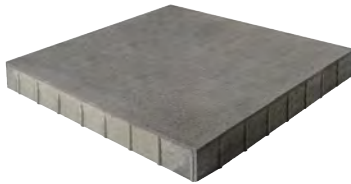

36 x 36 x 4"  
900 x 900 x 100mm  
*See Slabs section page  
106 for more details*



18 x 36 x 4"  
450 x 900 x 100mm  
*See Slabs section page  
106 for more details*

## EDGE DETAILS



ROUNDED EDGE  
100mm

## **UNILOCK** **DRIVECEL**

- Creates a revolutionary Reinforced Soil Structure (RSS) with high tensile and compressive strength to maximize the performance of pavement structures.
- Extremely permeable, long lasting, durable and environmentally friendly. Lightweight and easy to handle.
- Simple and quick installation.
- Allows for easy repairs / adjustments after installation.

See page 186-187 for more details.

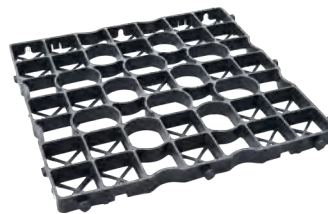

**DRIVECEL30 LIGHT DUTY**  
20 x 20 x 1.2"  
500 x 500 x 30mm

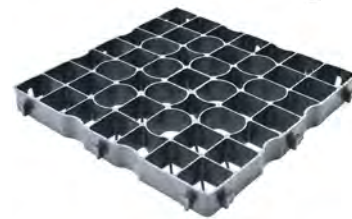

**DRIVECEL50 HEAVY DUTY**  
20 x 20 x 2"  
500 x 500 x 50mm

\*Colour selection should be chosen from actual samples.

**TECHNICAL INFORMATION**

**ASTM C936 Standard Specifications for Solid Concrete Interlocking Paving Units**



Conforms to:

- C140 for Absorption 5% avg - 7% max
- Compressive Strength > 7,200 PSI avg.
- C67 for Freeze-thaw Durability
- C418 for Abrasion Durability
- Dimensional Accuracy **+/- 3 mm**

*Test results available upon request*

**Meets the U.S. Architectural & Transportation Barrier Compliance Board Slip-Resistance Surfaces Advisory Guidelines**

**SOLAR REFLECTIVE INDEX (SRI) TESTING DETAILS**

Product	Solar Reflectance	SRI
Cream (custom)	0.45	52 
Summer Wheat	0.42	48 
Winter Marvel	0.35	38 

**TECHNICAL ADVANTAGES**

**ENDURACOLOR™**

Refined surface and long-lasting colour



Factory sealed for integral stain resistance

**COLORFUSION™**

Subtly mottled colour finish

**PEDESTRIAN FRIENDLY**

Not recommended for vehicular loads

**LEED INFORMATION**

**Rainwater Management: LEED V4:**

- Up to three points can be achieved for retaining rainwater onsite based on the percentile kept
- 85% (zero lot line projects only) - 3 points, 95% - 2 points and 98% - 3 points. (All except Healthcare - subtract one point) See LEED v4 for more specific project/site details.

**Materials and Resources: LEED V4:**

- Building Product Disclosure and Optimization
- Sourcing of Raw Materials - Sourcing of Raw Materials and Extraction • **1 point**
- Sourcing of Raw Materials - Leadership Extraction Practices • **1 point**
- Material Ingredient Reporting - Material Ingredient Reporting • **1 point**
- Material Ingredient Reporting - Material Ingredient Optimization • **1 point**
- Environmental Product Declaration • **1 point**

**PRODUCT DATA**

Stones & Bundling	Unit	SqFt Per				Per Bundle		Soldier LnFt Per			Sailor LnFt per			Units Per			Lbs Per		
	Thickness	Bundle	Layer	Section	Stone	Layers	Sections	Unit	Section	Bundle	Unit	Section	Bundle	SqFt	Layer	Bundle	Layer	Section	Bundle
<b>Georgetown Manufacturing</b>																			
36 x 36 x 4"	4" (100mm)	43.59	8.72	-	-	5	--	-	-	-	-	-	-	-	1	5	-	-	1,994
18 x 36 x 4"	4" (100mm)	43.59	8.72	-	-	5	-	-	-	-	-	-	-	-	2	10	-	-	1,994

Notes: 24" and 60mm Random products are not intended for vehicular applications. All measurements are nominal. **Sold in full bundles only** on a refundable skid.

**Important:** A urethane rubber paver mat must be used to prevent scuffing. For more information, samples or custom options, please contact your Unilock Territory Manager or call 1-800-UNILOCK.

**APPLICATIONS**



Pedestrian



Residential Vehicular (with DriveCel)



Roof Deck



\*Wall pairing suggestion- U-CARA<sup>®</sup> - matching colour and finish

**RECOMMENDED SANDS**

**RECOMMENDED SEALER**



**Romex: Rompox<sup>®</sup> Fugensand**  
Pedestrian, Vehicular and Heavy Duty Vehicular Applications

- Manufactured from natural, raw materials
- Quick application
- Self-repairing properties
- Suitable for all load classes
- No cement haze/residue due to natural polymer binder
- Three colours: Natural, Stone Grey and Basalt

**Coverage:**

Colour	3mm Joints
Neutral, Stone Grey, Basalt <i>1 L / 5 gal</i>	110 sqft / 55 lb bag 750 sqft / 5 gal drum

**Romex: Rompox<sup>®</sup> D7000 Joint Strengthener & Surface Sealer**  
Pedestrian, Vehicular and Heavy Duty Vehicular Applications

- All-in-one strengthener & sealer
- Eco-Friendly
- Protects against dirt, oil, corrosion from climate exposure, de-icing salts
- Protects against weed growth and wash outs

**Coverage:**

Colour	3mm Joints
Neutral, Stone Grey, Basalt <i>55 lb bag / 1 kg can</i>	110 sqft / 55 lb bag 750 sqft / 5 gal drum

**Alliance Gator G2 MAXX Sand**

- Rain safe after 15 minutes (24hr no rain if concrete overlay)
- Sets above 32° F/ 0° C - may vary depending on weather, drainage, bedding materials and installation
- Dust free and haze free
- Requires only one watering
- Four colours: Beige, Grey, Black and Ivory

**Coverage:**

Colour	Narrow Joints	Wide Joints
Beige, Grey, Ivory <i>50 lb bag</i>	65-85 sqft	22-42 sqft
Black <i>50 lb bag</i>	58-76 sqft	20-38 sqft

**Alliance Gator Hybrid Low Gloss + Colour Enhancer**

- Water-based
- Low gloss finish
- Vibrant Colour Enhancer
- Rain safe after 24 hours

**Coverage:**

Size	Area
3.78 L / 1 U.S. gal.	200 sqft
18.9 L / 5.28 U.S. gal.	1,000 sqft

\*Please refer to Sands & Sealers on pages 190-202 for more detailed information.

Unsure of bonded vs. unbonded product recommendations? Please contact your Unilock Territory Manager for more information.



ENDURACOLOR™ | UMRIANO® 100MM

PAVERS

# WESTPORT<sup>®</sup> SMOOTH

NEW FOR 2023

## CLASSIC



DUSK



SAFARI



CHARCOAL

Available in 5 x 10 only

## VISUAL APPEARANCE

Smooth with straight edge.

## FINISH

Factory-sealed and smooth.

## PRODUCT SPECIFICATIONS



LARGE RECTANGLE  
10 x 15 x 2<sup>3</sup>/<sub>4</sub>"  
250 x 375 x 70mm



SQUARE  
10 x 10 x 2<sup>3</sup>/<sub>4</sub>"  
250 x 250 x 70mm



SMALL RECTANGLE  
5 x 10 x 2<sup>3</sup>/<sub>4</sub>"  
125 x 250 x 70mm



SMALL RECTANGLE  
5 x 10 x 2<sup>3</sup>/<sub>4</sub>"  
125 x 250 x 70mm

3 UNIT RANDOM BUNDLE

## SMALL RECTANGLE



SMALL RECTANGLE  
5 x 10 x 2<sup>3</sup>/<sub>4</sub>"  
125 x 250 x 70mm

## EDGE DETAILS

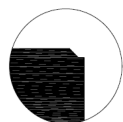

MICRO-BEVEL  
1.5mm

## BUNDLE CONFIGURATION

WESTPORT SMOOTH  
RANDOM BUNDLE



## BUNDLE CONFIGURATION

WESTPORT SMOOTH  
SM REC BUNDLE



## LAYING PATTERNS

WESTPORT SMOOTH  
RANDOM BUNDLE A

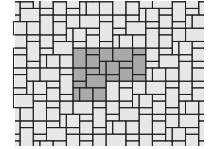

**TECHNICAL INFORMATION**

**ASTM C936 Standard Specifications for Solid Concrete Interlocking Paving Units**

Conforms to:

- C140 for Absorption 5% avg - 7% max
- Compressive Strength > 7,200 PSI avg.
- C67 for Freeze-thaw Durability
- C418 for Abrasion Durability
- Dimensional Accuracy **+/- 3 mm**

*Test results available upon request*

**Meets the U.S. Architectural & Transportation Barrier Compliance Board Slip-Resistance Surfaces Advisory Guidelines**

**LEED INFORMATION**

**Rainwater Management: LEED V4:**

- Up to three points can be achieved for retaining rainwater onsite based on the percentile kept
- 85% (zero lot line projects only) - 3 points, 95% - 2 points and 98% - 3 points. (All except Healthcare - subtract one point) See LEED v4 for more specific project/site details.

**Materials and Resources: LEED V4:**

- Building Product Disclosure and Optimization
- Sourcing of Raw Materials - Sourcing of Raw Materials and Extraction • **1 point**
- Sourcing of Raw Materials - Leadership Extraction Practices • **1 point**
- Material Ingredient Reporting - Material Ingredient Reporting • **1 point**
- Material Ingredient Reporting - Material Ingredient Optimization • **1 point**
- Environmental Product Declaration • **1 point**

**TECHNICAL ADVANTAGES**

**CLASSIC**

Budget-friendly. Utilizes a traditional product mix of large and small aggregates that's consistent from top to bottom with colour mixed throughout.

**ClassicCoat**

Factory sealed to protect surface texture and colour

**PRODUCT DATA**

Stones & Bundling	Unit	SqFt Per			Per Bundle	Soldier LnFt Per			Sailor LnFt per			Units Per			Lbs Per		
	Thickness	Bundle	Layer	Stone	Layers	Unit	Layer	Bundle	Unit	Layer	Bundle	SqFt	Section	Bundle	Layer	Section	Bundle
<b>Ayr Manufacturing</b>																	
Random Bundle		94.19	11.77	0.59	8	-	-	-	-	14.35	114.8	-	-	160	384.48	-	3,075.83
Large Rectangle	2 3/4" (70mm)	-	-	1.04	-	-	-	-	1.25	-	-	-	-	-	-	-	-
Square	2 3/4" (70mm)	-	-	0.69	-	-	-	-	0.83	-	-	-	-	-	-	-	-
Small Rectangle	2 3/4" (70mm)	-	-	0.38	-	-	-	-	0.42	-	-	-	-	-	-	-	-
Small Rectangle	2 3/4" (70mm)	94.19	11.77	0.38	8				0.83	14.35	233.33	2.97		280	384.48		3,016.91

Notes: Acceptable for driveways and walkways. Product sold in full bundles only on a refundable skid. **Important: A urethane rubber paver mat must be used to prevent scuffing.** All measurements are nominal. For more information, samples or custom options, please contact your Unilock Territory Manager or call 1-800-UNILOCK.

**APPLICATIONS**







Pedestrian



Residential Vehicular



\*Wall pairing suggestion- Lineo™ Dimensional Stone\*

RECOMMENDED SANDS			RECOMMENDED SEALER																				
 <p><b>Romex: Rompox® Fugensand</b> Pedestrian, Vehicular and Heavy Duty Vehicular Applications</p> <ul style="list-style-type: none"> <li>Manufactured from natural, raw materials</li> <li>Quick application</li> <li>Self-repairing properties</li> <li>Suitable for all load classes</li> <li>No cement haze/residue due to natural polymer binder</li> <li>Three colours: Natural, Stone Grey and Basalt</li> </ul> <p>Coverage:</p> <table border="1"> <tr><th>Colour</th><th>3mm Joints</th></tr> <tr><td>Neutral, Stone Grey, Basalt 1 L / 5 gal</td><td>110 sqft / 55 lb bag 750 sqft / 5 gal drum</td></tr> </table>	Colour	3mm Joints	Neutral, Stone Grey, Basalt 1 L / 5 gal	110 sqft / 55 lb bag 750 sqft / 5 gal drum	 <p><b>Romex: Rompox® D7000 Joint Strengthener &amp; Surface Sealer</b> Pedestrian, Vehicular and Heavy Duty Vehicular Applications</p> <ul style="list-style-type: none"> <li>All-in-one strengthener &amp; sealer</li> <li>Eco-Friendly</li> <li>Protects against dirt, oil, corrosion from climate exposure, de-icing salts</li> <li>Protects against weed growth and wash outs</li> </ul> <p>Coverage:</p> <table border="1"> <tr><th>Colour</th><th>3mm Joints</th></tr> <tr><td>Neutral, Stone Grey, Basalt 55 lb bag / 1 kg can</td><td>110 sqft / 55 lb bag 750 sqft / 5 gal drum</td></tr> </table>	Colour	3mm Joints	Neutral, Stone Grey, Basalt 55 lb bag / 1 kg can	110 sqft / 55 lb bag 750 sqft / 5 gal drum	 <p><b>Alliance Gator G2 Super Sand</b></p> <ul style="list-style-type: none"> <li>Rain safe after 1 hour (no concrete overlays)</li> <li>Sets above 32° F / 0° C - may vary depending on weather, drainage, bedding materials and installation</li> <li>Can be used for joints up to a max of 2"</li> <li>Dust free and haze free</li> <li>Requires only one watering</li> <li>Two colours: Beige, Slate Grey</li> </ul> <p>Coverage:</p> <table border="1"> <tr><th>Colour</th><th>Narrow Joints</th><th>Wide Joints</th></tr> <tr><td>Beige, Slate Grey 50 lb bag</td><td>65-85 sqft</td><td>22-42 sqft</td></tr> </table>	Colour	Narrow Joints	Wide Joints	Beige, Slate Grey 50 lb bag	65-85 sqft	22-42 sqft	 <p><b>Alliance Gator Hybrid Low Gloss + Colour Enhancer</b></p> <ul style="list-style-type: none"> <li>Water-based</li> <li>Low gloss finish</li> <li>Vibrant Colour Enhancer</li> <li>Rain safe after 24 hours</li> </ul> <p>Coverage:</p> <table border="1"> <tr><th>Size</th><th>Area</th></tr> <tr><td>3.78 L / 1 U.S. gal.</td><td>200 sqft</td></tr> <tr><td>18.9 L / 5.28 U.S. gal.</td><td>1,000 sqft</td></tr> </table>	Size	Area	3.78 L / 1 U.S. gal.	200 sqft	18.9 L / 5.28 U.S. gal.	1,000 sqft
Colour	3mm Joints																						
Neutral, Stone Grey, Basalt 1 L / 5 gal	110 sqft / 55 lb bag 750 sqft / 5 gal drum																						
Colour	3mm Joints																						
Neutral, Stone Grey, Basalt 55 lb bag / 1 kg can	110 sqft / 55 lb bag 750 sqft / 5 gal drum																						
Colour	Narrow Joints	Wide Joints																					
Beige, Slate Grey 50 lb bag	65-85 sqft	22-42 sqft																					
Size	Area																						
3.78 L / 1 U.S. gal.	200 sqft																						
18.9 L / 5.28 U.S. gal.	1,000 sqft																						

\*Please refer to Sands & Sealers on pages 190-202 for more detailed information.

Unsured of bonded vs. unbonded product recommendations? Please contact your Unilock Territory Manager for more information.

ENDURACOLOR™ | WESTPORT™ SMOOTH

PAVERS

# WINDERMERE® FLAGSTONE

## CLASSIC



CLIFFSIDE GREY



GRANITE BLEND



IRISH COAST

### VISUAL APPEARANCE

Gentle surface clefts and clean edges.

### FINISH

Flagstone finish.

### PRODUCT SPECIFICATIONS



#### LARGE RECTANGLE

14 $\frac{1}{16}$  x 21 $\frac{1}{4}$  x 2 $\frac{3}{4}$ "  
360 x 540 x 70mm



#### SQUARE

14 $\frac{1}{16}$  x 14 $\frac{1}{16}$  x 2 $\frac{3}{4}$ "  
360 x 360 x 70mm



#### SMALL RECTANGLE

7 $\frac{1}{8}$  x 14 $\frac{1}{16}$  x 2 $\frac{3}{4}$ "  
180 x 360 x 70mm

3 UNIT RANDOM BUNDLE

### EDGE DETAILS



WAVED EDGE

### BUNDLE CONFIGURATION

WINDERMERE  
RANDOM BUNDLE

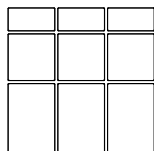

### LAYING PATTERNS

WINDERMERE A

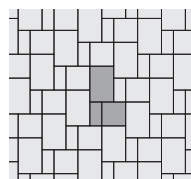

WINDERMERE B

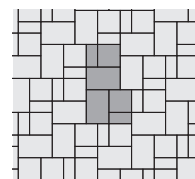

\*Colour selection should be chosen from actual samples.

**TECHNICAL INFORMATION**

**ASTM C936 Standard Specifications for Solid Concrete Interlocking Paving Units**

Conforms to:

- C140 for Absorption 5% avg - 7% max
- Compressive Strength > 7,200 PSI avg.
- C67 for Freeze-thaw Durability
- C418 for Abrasion Durability
- Dimensional Accuracy **+/- 3mm**

*Test results available upon request*

**Meets the U.S. Architectural & Transportation Barrier Compliance Board Slip-Resistance Surfaces Advisory Guidelines**

**LEED INFORMATION**

**Materials & Resources: LEED V4:**

- Building Product Disclosure and Optimization
- Sourcing of Raw Materials - Sourcing of Raw Materials and Extraction • **1 point**
- Sourcing of Raw Materials - Leadership Extraction Practices • **1 point**
- Material Ingredient Reporting - Material Ingredient Reporting • **1 point**
- Material Ingredient Reporting - Material Ingredient Optimization • **1 point**
- Environmental Product Declaration • **1 point**

**TECHNICAL ADVANTAGES**

**CLASSIC**

Budget-friendly. Utilizes a traditional product mix of large and small aggregates that's consistent from top to bottom with colour mixed throughout

**DRIVE FRIENDLY**

Can handle vehicular loads  
*Ask about our base stabilization system*

**PRODUCT DATA**

Stones & Bundling	Unit	SqFt Per			Per	Soldier LnFt Per			Sailor LnFt per			Units Per			Lbs Per			
	Thickness	Bundle	Layer	Stone	Layers	Unit	Section	Bundle	Unit	Section	Bundle	SqFt	Section	Bundle	Layer	Section	Bundle	
<b>Ayr Manufacturing</b>																		
Random Bundle		98	12.25	1.35	8	-	-	-	1.17	-	84.00	0.74	-	72	392	-	-	3,138
Large Rectangle	2¾" (70mm)	-	-	2.09	-	-	-	-	1.77	-	42.50	0.48	-	24	-	-	-	-
Small Rectangle	2¾" (70mm)	-	-	0.70	-	-	-	-	0.59	-	14.20	1.43	-	24	-	-	-	-
Square	2¾" (70mm)	-	-	1.40	-	-	-	-	1.18	-	28.30	0.72	-	24	-	-	-	-

Notes: Acceptable for driveways and walkways. Product sold in full bundles only on a refundable skid. **Important:** A urethane rubber paver mat must be used to prevent scuffing. All measurements are nominal. For more information, samples or custom options, please contact your Unilock Territory Manager or call 1-800-UNILOCK.

**APPLICATIONS**







Pedestrian



Residential Vehicular



\*Wall pairing suggestion- Pisa Smooth™

RECOMMENDED SANDS				RECOMMENDED SEALER																							
																											
<p><b>Rombox: Romex® Fugensand</b> Pedestrian, Vehicular and Heavy Duty Vehicular Applications</p> <ul style="list-style-type: none"> <li>Manufactured from natural, raw materials</li> <li>Quick application</li> <li>Self-repairing properties</li> <li>Suitable for all load classes</li> <li>No cement haze/residue due to natural polymer binder</li> <li>Three colours: Natural, Stone Grey and Basalt</li> </ul>		<p><b>Rombox: Romex® D7000 Joint Strengtheners &amp; Surface Sealer</b> Pedestrian, Vehicular and Heavy Duty Vehicular Applications</p> <ul style="list-style-type: none"> <li>All-in-one strengthener &amp; sealer</li> <li>Eco-Friendly</li> <li>Protects against dirt, oil, corrosion from climate exposure, de-icing salts</li> <li>Protects against weed growth and wash outs</li> </ul>		<p><b>Alliance Gator G2 Super Sand</b></p> <ul style="list-style-type: none"> <li>Rain safe after 1 hour (no concrete overlays)</li> <li>Sets above 32° F/ 0° C - may vary depending on weather, drainage, bedding materials and installation</li> <li>Can be used for joints up to a max of 2"</li> <li>Dust free and haze free</li> <li>Requires only one watering</li> <li>Two colours: Beige, Slate Grey</li> </ul>		<p><b>Alliance Gator Hybrid Low Gloss + Colour Enhancer</b></p> <ul style="list-style-type: none"> <li>Water-based</li> <li>Low gloss finish</li> <li>Vibrant Colour Enhancer</li> <li>Rain safe after 24 hours</li> </ul>																					
<p><b>Coverage:</b></p> <table border="1"> <thead> <tr> <th>Colour</th> <th>5-6mm Joints</th> </tr> </thead> <tbody> <tr> <td>Neutral, Stone Grey, Basalt 1 L / 5 gal</td> <td>50-150 sqft / 55 lb bag</td> </tr> </tbody> </table>		Colour	5-6mm Joints	Neutral, Stone Grey, Basalt 1 L / 5 gal	50-150 sqft / 55 lb bag	<p><b>Coverage:</b></p> <table border="1"> <thead> <tr> <th>Colour</th> <th>3-4mm Joints</th> </tr> </thead> <tbody> <tr> <td>Neutral, Stone Grey, Basalt 55 lb bag / 1 kg can</td> <td>50-150 sqft / 55 lb mix</td> </tr> </tbody> </table>		Colour	3-4mm Joints	Neutral, Stone Grey, Basalt 55 lb bag / 1 kg can	50-150 sqft / 55 lb mix	<p><b>Coverage:</b></p> <table border="1"> <thead> <tr> <th>Colour</th> <th>Narrow Joints</th> <th>Wide Joints</th> </tr> </thead> <tbody> <tr> <td>Beige, Slate Grey 50 lb bag</td> <td>65-85 sqft</td> <td>22-42 sqft</td> </tr> </tbody> </table>		Colour	Narrow Joints	Wide Joints	Beige, Slate Grey 50 lb bag	65-85 sqft	22-42 sqft	<p><b>Coverage:</b></p> <table border="1"> <thead> <tr> <th>Size</th> <th>Area</th> </tr> </thead> <tbody> <tr> <td>3.78 L / 1 U.S. gal.</td> <td>200 sqft</td> </tr> <tr> <td>18.9 L / 5.28 U.S. gal.</td> <td>1,000 sqft</td> </tr> </tbody> </table>		Size	Area	3.78 L / 1 U.S. gal.	200 sqft	18.9 L / 5.28 U.S. gal.	1,000 sqft
Colour	5-6mm Joints																										
Neutral, Stone Grey, Basalt 1 L / 5 gal	50-150 sqft / 55 lb bag																										
Colour	3-4mm Joints																										
Neutral, Stone Grey, Basalt 55 lb bag / 1 kg can	50-150 sqft / 55 lb mix																										
Colour	Narrow Joints	Wide Joints																									
Beige, Slate Grey 50 lb bag	65-85 sqft	22-42 sqft																									
Size	Area																										
3.78 L / 1 U.S. gal.	200 sqft																										
18.9 L / 5.28 U.S. gal.	1,000 sqft																										

\*Please refer to Sands & Sealers on pages 190-202 for more detailed information.

Unsure of bonded vs. unbonded product recommendations? Please contact your Unilock Territory Manager for more information.

# WINDERMERE<sup>®</sup> SMOOTH CLASSIC



CLIFFSIDE GREY

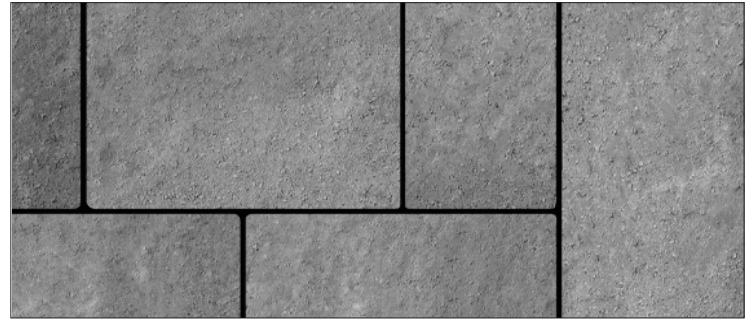

GRANITE BLEND



IRISH COAST



MIDNIGHT CHARCOAL

*Small Rectangle only*

## VISUAL APPEARANCE

Smooth with straight edge.

## FINISH

Smooth. Classic appearance.

## PRODUCT SPECIFICATIONS



**LARGE RECTANGLE**  
 $14\frac{1}{16} \times 21\frac{1}{4} \times 2\frac{3}{4}$ "  
 360 X 540 X 70mm



**SQUARE**  
 $14\frac{1}{16} \times 14\frac{1}{16} \times 2\frac{3}{4}$ "  
 360 x 360 x 70mm



**SMALL RECTANGLE**  
 $7\frac{1}{8} \times 14\frac{1}{16} \times 2\frac{3}{4}$ "  
 180 x 360 x 70mm



**SMALL RECTANGLE**  
 $7\frac{1}{8} \times 14\frac{1}{16} \times 2\frac{3}{4}$ "  
 180 x 360 x 70mm

*Only available in Midnight Charcoal*

3 UNIT RANDOM BUNDLE

## EDGE DETAILS



ROUNDED EDGE

## BUNDLE CONFIGURATION

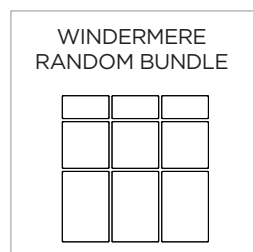

## LAYING PATTERNS

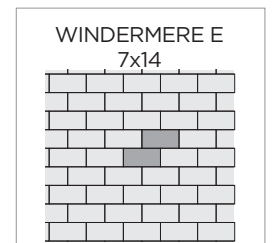
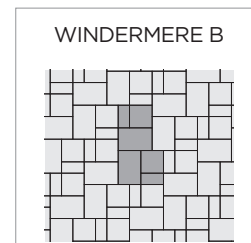
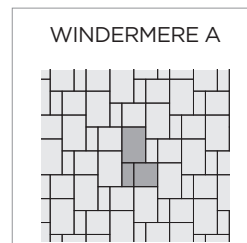

\*Colour selection should be chosen from actual samples.



**TECHNICAL INFORMATION**

**ASTM C936 Standard Specifications for Solid Concrete Interlocking Paving Units**

- Conforms to:
    - C140 for Absorption 5% avg - 7% max
    - Compressive Strength > 7,200 PSI avg.
    - C67 for Freeze-thaw Durability
    - C418 for Abrasion Durability
    - Dimensional Accuracy +/- 3mm
- Test results available upon request*

**Meets the U.S. Architectural & Transportation Barrier Compliance Board Slip-Resistance Surfaces Advisory Guidelines**

**LEED INFORMATION**

**Materials & Resources: LEED V4:**

- Building Product Disclosure and Optimization
- Sourcing of Raw Materials - Sourcing of Raw Materials and Extraction • **1 point**
- Sourcing of Raw Materials - Leadership Extraction Practices • **1 point**
- Material Ingredient Reporting - Material Ingredient Reporting • **1 point**
- Material Ingredient Reporting - Material Ingredient Optimization • **1 point**
- Environmental Product Declaration • **1 point**

**TECHNICAL ADVANTAGES**

**CLASSIC**

Budget-friendly. Utilizes a traditional product mix of large and small aggregates that's consistent from top to bottom with colour mixed throughout

**DRIVE FRIENDLY**

Can handle vehicular loads  
*Ask about our base stabilization system*

**PRODUCT DATA**

Stones & Bundling	Unit		SqFt Per			Per Bundle		Soldier LnFt Per			Sailor LnFt per			Units Per			Lbs Per		
	Thickness	Bundle	Layer	Stone	Layers	Unit	Section	Bundle	Unit	Section	Bundle	SqFt	Section	Bundle	Layer	Section	Bundle		
<b>Ayr Manufacturing</b>																			
Random Bundle		98	12.25	1.346	8	-	-	-	1.17	-	84.00	0.74	-	72	392	-	-	3,138	
Large Rectangle	2¾" (70mm)	-	-	2.093	-	-	-	-	1.77	-	42.50	0.48	-	24	-	-	-	-	
Small Rectangle	2¾" (70mm)	-	-	0.698	-	-	-	-	0.59	-	14.20	1.43	-	24	-	-	-	-	
Square	2¾" (70mm)	-	-	1.395	-	-	-	-	1.18	-	28.30	0.72	-	24	-	-	-	-	
Small Rectangle Bundle		98	12.25	-	-	0.58	-	83.90	1.18	-	168.00	1.47	-	144	392	-	-	3,138	

Notes: Acceptable for driveways and walkways. Product sold in full bundles only on a refundable skid. **Important:** A urethane rubber paver mat must be used to prevent scuffing. All measurements are nominal. For more information, samples or custom options, please contact your Unilock Territory Manager or call 1-800-UNILOCK.

**APPLICATIONS**

- Pedestrian
- Residential Vehicular
- \*Wall pairing suggestion- Pisa Smooth™

RECOMMENDED SANDS				RECOMMENDED SEALER																							
<p><b>Romex: Rompox® ECO-Fine</b> Pedestrian Applications only Vehicular when laid on a Trass Bed</p> <ul style="list-style-type: none"> <li>Ready mixed and easy to use</li> <li>Resin film free</li> <li>Resistant to ants, weeds, de-icing salts</li> <li>Made from 98% natural, recycled or renewable raw materials</li> <li>Pressure washer safe</li> <li>Ideal for joint widths from 5mm (1/4")</li> </ul> <p>Coverage:</p> <table border="1"> <tr> <th>Colour</th> <th>5-6mm Joints</th> </tr> <tr> <td>Beige, Stone Grey, Anthracite 55 lb bag / 1 kg can</td> <td>125 sqft / 55 lb mix</td> </tr> </table>		Colour	5-6mm Joints	Beige, Stone Grey, Anthracite 55 lb bag / 1 kg can	125 sqft / 55 lb mix	<p><b>Romex: Rompox® D1</b> Heavy-duty Vehicular Applications</p> <ul style="list-style-type: none"> <li>Light to medium vehicle rated</li> <li>Increased pouring capacity that is self-compacting and water emulsifiable</li> <li>Resistant to ants, weeds, de-icing salts</li> <li>Pressure washer safe</li> <li>Ideal for joint widths from 3mm (1/8")</li> <li>Ideal for driveways, parking spaces and all vehicular loading applications up to 7.5 T</li> <li>Three colours: Neutral, Stone Grey and Basalt</li> </ul> <p>Coverage:</p> <table border="1"> <tr> <th>Colour</th> <th>6mm Joints</th> </tr> <tr> <td>Neutral, Stone Grey, Basalt 2.5 L bottles to be mixed with 1 55 lb bag of Romex approved sand</td> <td>25 sqft / 55 lb mix (based on 1,000 sqft)</td> </tr> </table>		Colour	6mm Joints	Neutral, Stone Grey, Basalt 2.5 L bottles to be mixed with 1 55 lb bag of Romex approved sand	25 sqft / 55 lb mix (based on 1,000 sqft)	<p><b>Alliance Gator G2 Super Sand</b></p> <ul style="list-style-type: none"> <li>Rain safe after 1 hour (no concrete overlays)</li> <li>Sets above 32° F/ 0° C - may vary depending on weather, drainage, bedding materials and installation</li> <li>Can be used for joints up to a max of 2"</li> <li>Dust free and haze free</li> <li>Requires only one watering</li> <li>Two colours: Beige, Slate Grey</li> </ul> <p>Coverage:</p> <table border="1"> <tr> <th>Colour</th> <th>Narrow Joints</th> <th>Wide Joints</th> </tr> <tr> <td>Beige, Slate Grey 50 lb bag</td> <td>65-85 sqft</td> <td>22-42 sqft</td> </tr> </table>		Colour	Narrow Joints	Wide Joints	Beige, Slate Grey 50 lb bag	65-85 sqft	22-42 sqft	<p><b>Alliance Gator Hybrid Low Gloss + Colour Enhancer</b></p> <ul style="list-style-type: none"> <li>Water-based</li> <li>Low gloss finish</li> <li>Vibrant Colour Enhancer</li> <li>Rain safe after 24 hours</li> </ul> <p>Coverage:</p> <table border="1"> <tr> <th>Size</th> <th>Area</th> </tr> <tr> <td>3.78 L / 1 U.S. gal.</td> <td>200 sqft</td> </tr> <tr> <td>18.9 L / 5.28 U.S. gal.</td> <td>1,000 sqft</td> </tr> </table>		Size	Area	3.78 L / 1 U.S. gal.	200 sqft	18.9 L / 5.28 U.S. gal.	1,000 sqft
Colour	5-6mm Joints																										
Beige, Stone Grey, Anthracite 55 lb bag / 1 kg can	125 sqft / 55 lb mix																										
Colour	6mm Joints																										
Neutral, Stone Grey, Basalt 2.5 L bottles to be mixed with 1 55 lb bag of Romex approved sand	25 sqft / 55 lb mix (based on 1,000 sqft)																										
Colour	Narrow Joints	Wide Joints																									
Beige, Slate Grey 50 lb bag	65-85 sqft	22-42 sqft																									
Size	Area																										
3.78 L / 1 U.S. gal.	200 sqft																										
18.9 L / 5.28 U.S. gal.	1,000 sqft																										

\*Please refer to Sands & Sealers on pages 190-202 for more detailed information.

Unsured of bonded vs. unbonded product recommendations? Please contact your Unilock Territory Manager for more information.





UNILOCK® COLLECTION OF

# Slabs

For light duty patios, porch overlays and roof decks, our slab collection offers choices in natural stone, porcelain and durable concrete.

Arcana™ Slab (Modena)

# ARCANA™ SLAB

Exclusive to **UNILOCK**



## ENDURACOLOR™



AVORIO

*\*Special Order Colour*

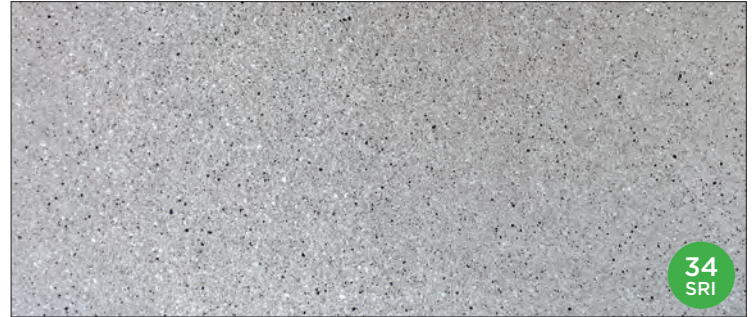

CORVARA



MODENA



VIVANTO

## VISUAL APPEARANCE

Granite, quartz and marble are exposed in the fine blasted surface of these large format slabs to deliver brilliant colour.

## FINISH

The silky, matte appearance of Arcana is further enhanced with EasyClean™ Stain Resistance for easier cleanup of spills and a non-slip surface.

## PRODUCT SPECIFICATIONS



23<sup>7</sup>/<sub>8</sub> x 23<sup>7</sup>/<sub>8</sub> x 2"  
610 x 610 x 50mm

*Special Order*



17<sup>7</sup>/<sub>8</sub> x 23<sup>7</sup>/<sub>8</sub> x 2"  
450 x 600 x 50mm

## EDGE DETAILS



MICRO BEVEL

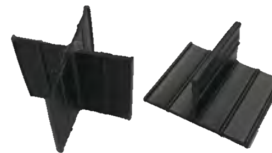

### X & T Slab Spacers

- 250 per bag
- X & T bagged separately
- T spacers 2" x 1"
- X spacers 2" x 2"

Unilock recommends using slab spacers when installing Arcana on an open grade surface. "T" spacers are needed for running bond patterns. "X" spacers are needed for stack bond patterns. Please contact your Unilock Territory Manager for more information.

\*Colour selection should be chosen from actual samples.

**TECHNICAL INFORMATION**

**ASTM C 936 Standard Specifications for Solid Concrete Interlocking Paving Units**





Conforms to:

- C140 for Absorption 5% avg - 7% max
- Compressive Strength > 7,200 PSI avg.
- C67 for Freeze-thaw Durability
- C418 for Abrasion Durability
- Dimensional Accuracy **+/- 3 mm**

*Test results available upon request*

**Meets the U.S. Architectural & Transportation Barrier Compliance Board Slip-Resistance Surfaces Advisory Guidelines**

**SOLAR REFLECTIVE INDEX (SRI) TESTING DETAILS**

Product	Solar Reflectance	SRI
Avorio <i>Special Order</i>	0.56	66 
Corvara	0.30	34 
Modena	0.46	53 
Vivanto	0.18	16 

**TECHNICAL ADVANTAGES**

**ENDURACOLOR™**

Refined surface and long-lasting colour

Enhanced surface appearance



Factory sealed for integral stain resistance

**PEDESTRIAN FRIENDLY**

Not recommended for vehicular loads

**LEED INFORMATION**

**Materials & Resources: LEED V4:**

Building Product Disclosure and Optimization

Sourcing of Raw Materials - Sourcing of Raw Materials and Extraction • **1 point**

Sourcing of Raw Materials - Leadership Extraction Practices • **1 point**

Material Ingredient Reporting - Material Ingredient Reporting • **1 point**

Material Ingredient Reporting - Material Ingredient Optimization • **1 point**

Environmental Product Declaration • **1 point**

**PRODUCT DATA**

Stones & Bundling	Unit		SqFt Per			Per Bundle		Soldier LnFt Per			Sailor LnFt per			Units Per			Lbs Per		
	Thickness	Bundle	Layer	Section	Stone	Layers	Sections	Unit	Section	Bundle	Unit	Section	Bundle	SqFt	Layer	Bundle	Layer	Section	Bundle
<b>Chicago Manufacturing / Stocked in Ayr</b>																			
23 7/8 x 23 7/8 x 2"	2" (50mm)	72	8	-	4	9	-	1.99	-	35.79	1.99	-	35.79	0.25	2	18	192	-	1,728
17 7/8 x 23 7/8 x 2"	2" (50mm)	54	6	-	3	9	-	1.49	-	26.75	1.99	-	35.79	0.33	2	18	144	-	1,296

Notes: Product sold in full bundles only on a refundable skid. All measurements are nominal. Unilock recommends that you do not use a plate tamper to compact. Dead blow or roller tamper only. For more information, samples or custom options, please contact your Unilock Territory Manager or call 1-800-UNILOCK.

**APPLICATIONS**



Pedestrian



Roof Deck



\*Wall pairing suggestion- U-CARA\*

**RECOMMENDED SANDS**

**RECOMMENDED SEALER**



**Romex: Rompox™ ECO-Fine**  
Pedestrian Applications only

- | Ready mixed and easy to use
- | Resin film free
- | Resistant to ants, weeds, de-icing salts
- | Made from 98% natural, recycled or renewable raw materials
- | Pressure washer safe
- | Ideal for joint widths from 5mm (1/4")

Coverage:

Colour	5-6mm Joints
Beige, Stone Grey, Anthracite 55 lb bag / 1 kg can	125 sqft / 55 lb mix



**Alliance Gator G2 MAXX Sand**

- | Rain safe after 15 minutes (24hr no rain if concrete overlay)
- | Sets above 32° F/ 0° C - may vary depending on weather, drainage, bedding materials and installation
- | Dust free and haze free
- | Requires only one watering
- | Four colours: Beige, Grey, Black and Ivory

Coverage:

Colour	Narrow Joints	Wide Joints
Beige, Grey, Ivory 50 lb bag	65-85 sqft	22-42 sqft
Black 50 lb bag	58-76 sqft	20-38 sqft



**Alliance Gator Hybrid Low Gloss + Colour Enhancer**

- | Water-based
- | Low gloss finish
- | Vibrant Colour Enhancer
- | Rain safe after 24 hours

Coverage:

Size	Area
3.78 L / 1 U.S. gal.	200 sqft
18.9 L / 5.28 U.S. gal.	1,000 sqft

\*Please refer to Sands & Sealers on pages 190-202 for more detailed information.

Unsure of bonded vs. unbonded product recommendations? Please contact your Unilock Territory Manager for more information.

# BEACON HILL™ SMOOTH SLAB

ENDURACOLOR™



FOSSIL



GRANITE MIST

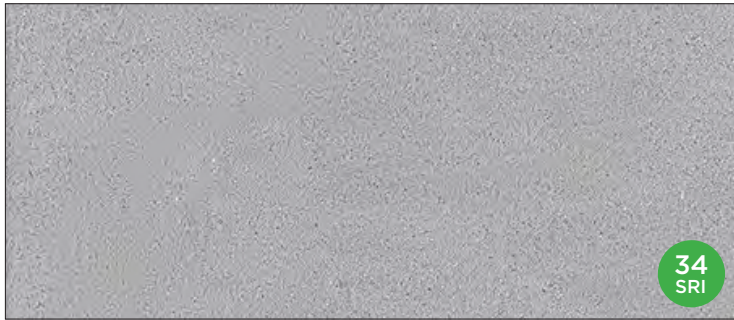

OPAL BLEND

## VISUAL APPEARANCE

Beacon Hill™ Smooth offers a smooth surface texture for a sleek, modern look with a contemporary colour palette.

## FINISH

Smooth with EnduraColor finish.

## PRODUCT SPECIFICATIONS

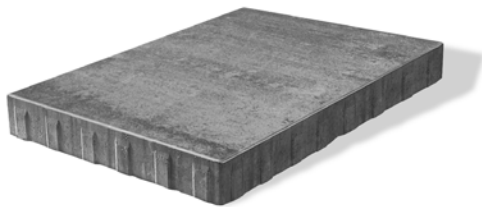

### SLAB

22<sup>7</sup>/<sub>16</sub> x 37<sup>3</sup>/<sub>8</sub> x 2<sup>3</sup>/<sub>8</sub>"  
570 x 950 x 60mm

## EDGE DETAILS

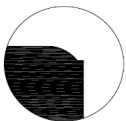

ROUNDED EDGE

\*Colour selection should be chosen from actual samples.

**TECHNICAL INFORMATION**

**ASTM C 936 Standard Specifications for Solid Concrete Interlocking Paving Units**

Conforms to:

- C140 for Absorption 4% avg - 5% max
- Compressive Strength > 8,000 PSI avg.
- C1645 for Freeze-thaw Durability
- C418 for Abrasion Durability
- Dimensional Accuracy **+/- 3mm**

Test results available upon request

**Meets the U.S. Architectural & Transportation Barrier Compliance Board Slip-Resistance Surfaces Advisory Guidelines**

**SOLAR REFLECTIVE INDEX (SRI) TESTING DETAILS**

Product	Solar Reflectance	SRI
Opal Blend	0.32	34 

**LEED INFORMATION**

**Materials & Resources: LEED V4:**

- Building Product Disclosure and Optimization
- Sourcing of Raw Materials - Sourcing of Raw Materials and Extraction • **1 point**
- Sourcing of Raw Materials - Leadership Extraction Practices • **1 point**
- Material Ingredient Reporting - Material Ingredient Reporting • **1 point**
- Material Ingredient Reporting - Material Ingredient Optimization • **1 point**
- Environmental Product Declaration • **1 point**

**TECHNICAL ADVANTAGES**

**ENDURACOLOR**

Refined surface and long-lasting colour

**PEDESTRIAN FRIENDLY**

Not recommended for vehicular

**PRODUCT DATA**

Stones & Bundling	Unit		SqFt Per				Per Bundle		Soldier LnFt Per			Sailor LnFt per			Units Per			Lbs Per		
	Thickness	Bundle	Layer	Section	Stone	Layers	Sections	Unit	Section	Bundle	Unit	Section	Bundle	SqFt	Section	Bundle	Layer	Section	Bundle	
<b>Ayr Manufacturing</b>																				
Slab (Smooth Only)	2 1/2" (60mm)	69.94	11.66	-	5.83	6	-	1.87	-	22.44	3.12	-	37.38	0.17	-	12	319.80	-	1,918.80	

Notes: Sold in full bundles only on a refundable skid. **Beacon Hill 60mm is not intended for vehicular applications.** All measurements are nominal. **Important: A urethane rubber paver mat must be used to prevent scuffing.** For more information, samples or custom options, please contact your Unilock Territory Manager or call 1-800-UNILOCK.

**APPLICATIONS**





Pedestrian



Roof Deck



\*Wall pairing suggestion- U-CARA® - matching colour and finish

RECOMMENDED SANDS		RECOMMENDED SEALER														
 <p><b>Romex: Rompox® ECO-Fine</b> Pedestrian Applications only</p> <ul style="list-style-type: none"> <li>  Ready mixed and easy to use</li> <li>  Resin film free</li> <li>  Resistant to ants, weeds, de-icing salts</li> <li>  Made from 98% natural, recycled or renewable raw materials</li> <li>  Pressure washer safe</li> <li>  Ideal for joint widths from 5mm (1/4")</li> </ul> <p>Coverage:</p> <table border="1"> <thead> <tr> <th>Colour</th> <th>5-6mm Joints</th> </tr> </thead> <tbody> <tr> <td>Beige, Stone Grey, Anthracite 55 lb bag / 1 kg can</td> <td>125 sqft / 55 lb mix</td> </tr> </tbody> </table>		Colour	5-6mm Joints	Beige, Stone Grey, Anthracite 55 lb bag / 1 kg can	125 sqft / 55 lb mix	 <p><b>Alliance Gator G2 MAXX Sand</b></p> <ul style="list-style-type: none"> <li>  Rain safe after 15 minutes (24hr no rain if concrete overlay)</li> <li>  Sets above 32° F/ 0° C - may vary depending on weather, drainage, bedding materials and installation</li> <li>  Dust free and haze free</li> <li>  Requires only one watering</li> <li>  Four colours: Beige, Grey, Black and Ivory</li> </ul> <p>Coverage:</p> <table border="1"> <thead> <tr> <th>Colour</th> <th>Narrow Joints</th> <th>Wide Joints</th> </tr> </thead> <tbody> <tr> <td>Beige, Grey, Ivory 50 lb bag</td> <td>65-85 sqft</td> <td>22-42 sqft</td> </tr> <tr> <td>Black 50 lb bag</td> <td>58-76 sqft</td> <td>20-38 sqft</td> </tr> </tbody> </table>		Colour	Narrow Joints	Wide Joints	Beige, Grey, Ivory 50 lb bag	65-85 sqft	22-42 sqft	Black 50 lb bag	58-76 sqft	20-38 sqft
Colour	5-6mm Joints															
Beige, Stone Grey, Anthracite 55 lb bag / 1 kg can	125 sqft / 55 lb mix															
Colour	Narrow Joints	Wide Joints														
Beige, Grey, Ivory 50 lb bag	65-85 sqft	22-42 sqft														
Black 50 lb bag	58-76 sqft	20-38 sqft														
		 <p><b>Alliance Gator Natural Look Sealer</b></p> <ul style="list-style-type: none"> <li>  Water-based</li> <li>  Zero gloss finish</li> <li>  Multi purpose</li> <li>  Rain safe after 24 hours</li> </ul> <p>Coverage:</p> <table border="1"> <thead> <tr> <th>Size</th> <th>Area</th> </tr> </thead> <tbody> <tr> <td>3.78 L / 1 U.S. gal.</td> <td>175 sqft</td> </tr> <tr> <td>18.9 L / 5.28 U.S. gal.</td> <td>875 sqft</td> </tr> </tbody> </table>		Size	Area	3.78 L / 1 U.S. gal.	175 sqft	18.9 L / 5.28 U.S. gal.	875 sqft							
Size	Area															
3.78 L / 1 U.S. gal.	175 sqft															
18.9 L / 5.28 U.S. gal.	875 sqft															

\*Please refer to Sands & Sealers on pages 190-202 for more detailed information.

Unsured of bonded vs. unbonded product recommendations? Please contact your Unilock Territory Manager for more information.

# METRO SLAB™

## CLASSIC



DUSK **NEW**



MIDNIGHT CHARCOAL



SAFARI **NEW**

### VISUAL APPEARANCE

A budget-friendly option for patios, walkways and pool decks where a large size slab is preferred. Available in grey, black and tan tones, this 15" x 30" unit creates a clean, modern look.

### FINISH

Smooth, classic finish.

### PRODUCT SPECIFICATIONS

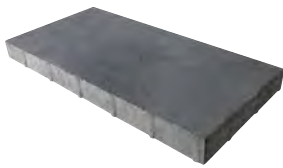

15 x 30 x 2 $\frac{3}{8}$ "  
380 x 760 x 60mm

### EDGE DETAILS



ROUNDED EDGE

\*Colour selection should be chosen from actual samples.



**TECHNICAL INFORMATION**

**ASTM C 936 Standard Specifications for Solid Concrete Interlocking Paving Units**

- Conforms to:
- C140 for Absorption 5% avg - 7% max
  - Compressive Strength > 7,200 PSI avg.
  - C67 for Freeze-thaw Durability
  - C418 for Abrasion Durability
  - Dimensional Accuracy **+/- 3mm**
- Test results available upon request*

**Meets the U.S. Architectural & Transportation Barrier Compliance Board Slip-Resistance Surfaces Advisory Guidelines**

**LEED INFORMATION**

**Materials & Resources: LEED V4:**

- Building Product Disclosure and Optimization
- Sourcing of Raw Materials - Sourcing of Raw Materials and Extraction • **1 point**
- Sourcing of Raw Materials - Leadership Extraction Practices • **1 point**
- Material Ingredient Reporting - Material Ingredient Reporting • **1 point**
- Material Ingredient Reporting - Material Ingredient Optimization • **1 point**
- Environmental Product Declaration • **1 point**

**TECHNICAL ADVANTAGES**

**CLASSIC**

These products utilize a traditional product mix of large and small aggregates that's consistent from top to bottom with colour mixed throughout

**ClassicCoat**

Factory sealed to protect surface texture and colour

**PEDESTRIAN FRIENDLY**

Not recommended for vehicular loads

**PRODUCT DATA**

Stones & Bundling	Unit Thickness	SqFt Per				Per Bundle		Soldier LnFt Per			Sailor LnFt per			Units Per			Lbs Per		
		Bundle	Layer	Section	Stone	Layers	Sections	Unit	Layer	Bundle	Unit	Layer	Bundle	SqFt	Section	Bundle	Layer	Section	Bundle
<b>Ayr Manufacturing</b>																			
15" x 30"	2 3/8" (60mm)	54.50	9.08	-	3.03	6	-	1.25	-	22.44	2.50	-	44.08	0.33	-	18	249	-	1,496

Notes: Sold in full bundles only on a refundable skid. Metro Slab 60mm is not suitable for vehicular applications. All measurements are nominal. **Important: A urethane rubber paver mat must be used to prevent scuffing.** For more information, samples or custom options, please contact your Unilock Territory Manager or call 1-800-UNILOCK.

**APPLICATIONS**







Pedestrian



Borders and Accents



\*Wall pairing suggestion- U-CARA® Wall or Lineo™ Dimensional Stone

RECOMMENDED SANDS						RECOMMENDED SEALER																					
																											
<p><b>Romex: Rompox® Fugensand</b> Pedestrian, Vehicular and Heavy Duty Vehicular Applications</p> <ul style="list-style-type: none"> <li>Manufactured from natural, raw materials</li> <li>Quick application</li> <li>Self-repairing properties</li> <li>Suitable for all load classes</li> <li>No cement haze/residue due to natural polymer binder</li> <li>Three colours: Natural, Stone Grey and Basalt</li> </ul>		<p><b>Romex: Rompox® D7000 Joint Strengthener &amp; Surface Sealer</b> Pedestrian, Vehicular and Heavy Duty Vehicular Applications</p> <ul style="list-style-type: none"> <li>All-in-one strengthener &amp; sealer</li> <li>Eco-Friendly</li> <li>Protects against dirt, oil, corrosion from climate exposure, de-icing salts</li> <li>Protects against weed growth and wash outs</li> </ul>		<p><b>Alliance Gator G2 Super Sand</b></p> <ul style="list-style-type: none"> <li>Rain safe after 1 hour (no concrete overlays)</li> <li>Sets above 32° F/ 0° C - may vary depending on weather, drainage, bedding materials and installation</li> <li>Can be used for joints up to a max of 2"</li> <li>Dust free and haze free</li> <li>Requires only one watering</li> <li>Two colours: Beige, Slate Grey</li> </ul>		<p><b>Alliance Gator Natural Look Sealer</b></p> <ul style="list-style-type: none"> <li>Water-based</li> <li>Zero gloss finish</li> <li>Multi purpose</li> <li>Rain safe after 24 hours</li> </ul>																					
<p><b>Coverage:</b></p> <table border="1"> <thead> <tr> <th>Colour</th> <th>5-6mm Joints</th> </tr> </thead> <tbody> <tr> <td>Neutral, Stone Grey, Basalt <i>1 L / 5 gal</i></td> <td>50-150 sqft / 55 lb bag</td> </tr> </tbody> </table>		Colour	5-6mm Joints	Neutral, Stone Grey, Basalt <i>1 L / 5 gal</i>	50-150 sqft / 55 lb bag	<p><b>Coverage:</b></p> <table border="1"> <thead> <tr> <th>Colour</th> <th>3-4mm Joints</th> </tr> </thead> <tbody> <tr> <td>Neutral, Stone Grey, Basalt <i>55 lb bag / 1 kg can</i></td> <td>50-150 sqft / 55 lb mix</td> </tr> </tbody> </table>		Colour	3-4mm Joints	Neutral, Stone Grey, Basalt <i>55 lb bag / 1 kg can</i>	50-150 sqft / 55 lb mix	<p><b>Coverage:</b></p> <table border="1"> <thead> <tr> <th>Colour</th> <th>Narrow Joints</th> <th>Wide Joints</th> </tr> </thead> <tbody> <tr> <td>Beige, Slate Grey <i>50 lb bag</i></td> <td>65-85 sqft</td> <td>22-42 sqft</td> </tr> </tbody> </table>		Colour	Narrow Joints	Wide Joints	Beige, Slate Grey <i>50 lb bag</i>	65-85 sqft	22-42 sqft	<p><b>Coverage:</b></p> <table border="1"> <thead> <tr> <th>Size</th> <th>Area</th> </tr> </thead> <tbody> <tr> <td>3.78 L / 1 U.S. gal.</td> <td>175 sqft</td> </tr> <tr> <td>18.9 L / 5.28 U.S. gal.</td> <td>875 sqft</td> </tr> </tbody> </table>		Size	Area	3.78 L / 1 U.S. gal.	175 sqft	18.9 L / 5.28 U.S. gal.	875 sqft
Colour	5-6mm Joints																										
Neutral, Stone Grey, Basalt <i>1 L / 5 gal</i>	50-150 sqft / 55 lb bag																										
Colour	3-4mm Joints																										
Neutral, Stone Grey, Basalt <i>55 lb bag / 1 kg can</i>	50-150 sqft / 55 lb mix																										
Colour	Narrow Joints	Wide Joints																									
Beige, Slate Grey <i>50 lb bag</i>	65-85 sqft	22-42 sqft																									
Size	Area																										
3.78 L / 1 U.S. gal.	175 sqft																										
18.9 L / 5.28 U.S. gal.	875 sqft																										

\*Please refer to Sands & Sealers on pages 190-202 for more detailed information.

Unsure of bonded vs. unbonded product recommendations? Please contact your Unilock Territory Manager for more information.

# PROMENADE™ PLANK SLAB

ENDURACOLOR™



OPAL BLEND (SMOOTH FINISH)



STEEL GREY BLEND (SMOOTH FINISH)



GRANITE BLEND (IL CAMPO® FINISH)



LIGHT GREY (IL CAMPO® FINISH)



DARK CHARCOAL (IL CAMPO® FINISH)



BLACK GRANITE (SERIES™ FINISH)

## VISUAL APPEARANCE

Long and narrow design facilitates a linear laying pattern resulting in a finished and sleek appearance to complement current architectural design trends, leaving no compromise on style for heavy-duty functionality.

## FINISH

Available in a variety of Unilock Select finishes such as Il Campo®, Series™ (Stock) and Umbriano® (Custom), to name a few.

## PRODUCT SPECIFICATIONS



8 x 24 x 4"  
200 x 600 x 100mm

## EDGE DETAILS



ROUNDED EDGE

## LAYING PATTERNS

PROMENADE PLANK  
PAVER A 8 x 24

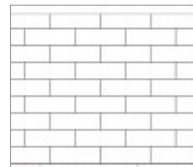

PROMENADE PLANK PAVER A 8X24  
100% 8 x 24

\*Colour selection should be chosen from actual samples.

TECHNICAL INFORMATION

ASTM C 936 Standard Specifications for Solid Concrete Interlocking Paving Units

Conforms to:

- C140 for Absorption 5% avg - 7% max
  - Compressive Strength > 7,200 PSI avg.
  - C67 for Freeze-thaw Durability
  - C418 for Abrasion Durability
  - Dimensional Accuracy +/- 3mm
- Test results available upon request

Meets the U.S. Architectural & Transportation Barrier Compliance Board Slip-Resistance Surfaces Advisory Guidelines

SOLAR REFLECTIVE INDEX (SRI) TESTING DETAILS

Product	Solar Reflectance	SRI
Opal Blend	0.32	34 

LEED INFORMATION

Materials & Resources: LEED V4:

- Building Product Disclosure and Optimization
- Sourcing of Raw Materials - Sourcing of Raw Materials and Extraction • 1 point
- Sourcing of Raw Materials - Leadership Extraction Practices • 1 point
- Material Ingredient Reporting - Material Ingredient Reporting • 1 point
- Material Ingredient Reporting - Material Ingredient Optimization • 1 point
- Environmental Product Declaration • 1 point

TECHNICAL ADVANTAGES

ENDURACOLOR™

Refined surface and long-lasting colour

DRIVE FRIENDLY

Can handle vehicular loads  
Ask about our base stabilization system

IL CAMPO FINISH

Graphically interesting etched lines

SERIES FINISH

Granite, Quartz and Marble surface materials

PRODUCT DATA

Stones & Bundling	Unit	SqFt Per				Per Bundle		Soldier LnFt Per			Sailor LnFt per			Units Per			Lbs Per		
	Thickness	Bundle	Layer	Section	Stone	Layers	Sections	Unit	Layer	Bundle	Unit	Layer	Bundle	SqFt	Section	Bundle	Layer	Section	Bundle
<b>Georgetown Manufacturing</b>																			
8" x 24"	4" (100mm)	51.67	10.33	-	1.29	5	-	0.66	-	26.20	1.97	-	78.70	0.77	-	40	478	-	2,391

Notes: Sold in full bundles only on a refundable skid. **Important:** A urethane rubber paver mat must be used to prevent scuffing. All measurements are nominal. For more information, samples or custom options, please contact your Unilock Territory Manager or call 1-800-UNILOCK.

APPLICATIONS



Pedestrian



Residential Vehicular



Borders and Accents



\*Wall pairing suggestion- U-CARA® Wall or Lineo™ Dimensional Stone

RECOMMENDED SANDS

RECOMMENDED SEALER



**Romex: Rompox® Fugensand**  
Pedestrian, Vehicular and Heavy Duty Vehicular Applications

- | Manufactured from natural, raw materials
- | Quick application
- | Self-repairing properties
- | Suitable for all load classes
- | No cement haze/residue due to natural polymer binder
- | Three colours: Natural, Stone Grey and Basalt

**Romex: Rompox® D7000 Joint Strengthener & Surface Sealer**  
Pedestrian, Vehicular and Heavy Duty Vehicular Applications

- | All-in-one strengthener & sealer
- | Eco-Friendly
- | Protects against dirt, oil, corrosion from climate exposure, de-icing salts
- | Protects against weed growth and wash outs

**Alliance Gator G2 MAXX Sand**

- | Rain safe after 15 minutes (24hr no rain if concrete overlay)
- | Sets above 32° F/ 0° C - may vary depending on weather, drainage, bedding materials and installation
- | Dust free and haze free
- | Requires only one watering
- | Four colours: Beige, Grey, Black and Ivory

**Alliance Gator Hybrid Low Gloss + Colour Enhancer**

- | Water-based
- | Low gloss finish
- | Vibrant Colour Enhancer
- | Rain safe after 24 hours

Coverage:

Colour	3mm Joints
Neutral, Stone Grey, Basalt 1 L / 5 gal	110 sqft / 55 lb bag 750 sqft / 5 gal drum

Coverage:

Colour	3mm Joints
Neutral, Stone Grey, Basalt 55 lb bag / 1 kg can	110 sqft / 55 lb bag 750 sqft / 5 gal drum

Coverage:

Colour	Narrow Joints	Wide Joints
Beige, Grey, Ivory 50 lb bag	65-85 sqft	22-42 sqft
Black 50 lb bag	58-76 sqft	20-38 sqft

Coverage:

Size	Area
3.78 L / 1 U.S. gal.	200 sqft
18.9 L / 5.28 U.S. gal.	1,000 sqft

\*Please refer to Sands & Sealers on pages 190-202 for more detailed information.

Unsure of bonded vs. unbonded product recommendations? Please contact your Unilock Territory Manager for more information.

# REVELA™ SLAB

ENDURACOLOR™

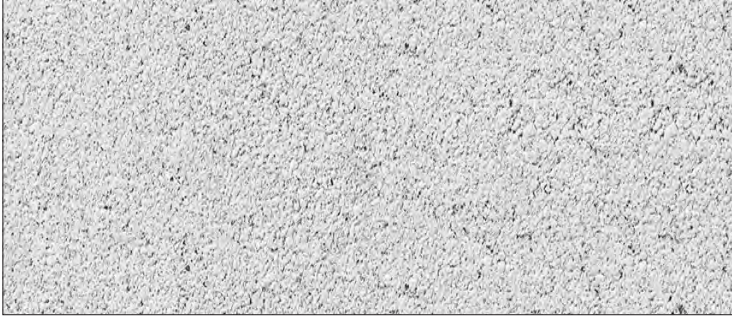

FROST **NEW**



METALLIC GREY

18  
SRI



SAVANNAH

## VISUAL APPEARANCE

Large size slab with a unique textured finish to complement current architectural design trends.

## FINISH

Shotblasted.

## PRODUCT SPECIFICATIONS



### SLAB

21 x 35 x 2 $\frac{3}{8}$ "

540 x 890 x 60mm

## EDGE DETAILS



ROUNDED EDGE

\*Colour selection should be chosen from actual samples.

**TECHNICAL INFORMATION**

**ASTM C 936 Standard Specifications for Solid Concrete Interlocking Paving Units**

- Conforms to:
- C140 for Absorption 5% avg - 7% max
  - Compressive Strength > 7,200 PSI avg.
  - C67 for Freeze-thaw Durability
  - C418 for Abrasion Durability
  - Dimensional Accuracy +/- 3mm
- Test results available upon request*

**Meets the U.S. Architectural & Transportation Barrier Compliance Board Slip-Resistance Surfaces Advisory Guidelines**

**SOLAR REFLECTIVE INDEX (SRI) TESTING DETAILS**

Product	Solar Reflectance	SRI
Metallic Grey	0.19	18 

**TECHNICAL ADVANTAGES**

**ENDURACOLOR™**

Refined surface and long-lasting colour

Enhanced surface appearance

**PEDESTRIAN FRIENDLY**

Not recommended for vehicular loads

**LEED INFORMATION**

**Materials & Resources: LEED V4:**

- Building Product Disclosure and Optimization
- Sourcing of Raw Materials - Sourcing of Raw Materials and Extraction • **1 point**
- Sourcing of Raw Materials - Leadership Extraction Practices • **1 point**
- Material Ingredient Reporting - Material Ingredient Reporting • **1 point**
- Material Ingredient Reporting - Material Ingredient Optimization • **1 point**
- Environmental Product Declaration • **1 point**

**PRODUCT DATA**

Stones & Bundling	Unit	SqFt Per				Per Bundle		Soldier LnFt Per			Sailor LnFt per			Units Per			Lbs Per		
	Thickness	Bundle	Layer	Section	Stone	Layers	Section	Unit	Section	Bundle	Unit	Section	Bundle	SqFt	Section	Bundle	Layer	Section	Bundle
<b>Georgetown Manufacturing</b>																			
21" x 35"	2 3/8" (60mm)	62.78	10.46	-	5.23	6	-	1.77	-	21.24	2.91	-	35.46	0.19	-	12	287	-	1,723

Notes: Sold in full bundles only on a refundable skid. **Important: A urethane rubber paver mat must be used to prevent scuffing.** All measurements are nominal. For more information, samples or custom options, please contact your Unilock Territory Manager or call 1-800-UNILOCK.

**APPLICATIONS**



Pedestrian



Roof Deck



\*Wall pairing suggestion- U-CARA® Wall or Lineo™ Dimensional Stone

**RECOMMENDED SANDS**

**RECOMMENDED SEALER**



**Romex: Rompox® ECO-Fine**  
Pedestrian Applications only

- | Ready mixed and easy to use
- | Resin film free
- | Resistant to ants, weeds, de-icing salts
- | Made from 98% natural, recycled or renewable raw materials
- | Pressure washer safe
- | Ideal for joint widths from 5mm (1/4")

**Coverage:**

Colour	5-6mm Joints
Beige, Stone Grey, Anthracite 55 lb bag / 1 kg can	125 sqft / 55 lb mix



**Alliance Gator G2 MAXX Sand**

- | Rain safe after 15 minutes (24hr no rain if concrete overlay)
- | Sets above 32° F/ 0° C - may vary depending on weather, drainage, bedding materials and installation
- | Dust free and haze free
- | Requires only one watering
- | Four colours: Beige, Grey, Black and Ivory

**Coverage:**

Colour	Narrow Joints	Wide Joints
Beige, Grey, Ivory 50 lb bag	65-85 sqft	22-42 sqft
Black 50 lb bag	58-76 sqft	20-38 sqft



**Alliance Gator Hybrid Low Gloss + Colour Enhancer**

- | Water-based
- | Low gloss finish
- | Vibrant Colour Enhancer
- | Rain safe after 24 hours

**Coverage:**

Size	Area
3.78 L / 1 U.S. gal.	200 sqft
18.9 L / 5.28 U.S. gal.	1,000 sqft

\*Please refer to Sands & Sealers on pages 190-202 for more detailed information.

Unsure of bonded vs. unbonded product recommendations? Please contact your Unilock Territory Manager for more information.

# SKYLINE™ SLAB

NEW FOR 2023



ENDURACOLOR™



GRENADA WHITE - UMBRIANO\*



LIGHT GREY - CLASSIC

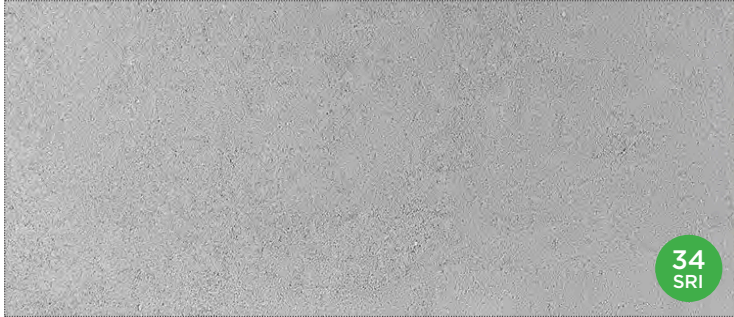

OPAL BLEND - SMOOTH FINISH

## VISUAL APPEARANCE

The sleek sizes of Skyline are ideal for roof decks, walkways, patios or pool decks to give that modern, contemporary look.

## FINISH

Skyline is available in a Classic thru-mix finish, or you can upgrade to EnduraColor for a more refined surface and long-lasting color. Skyline slabs can be further enhanced by adding EasyClean®, an integral surface protection from stains.

## PRODUCT SPECIFICATIONS



24 x 24 x 2"  
600 x 600 x 50mm



12 x 24 x 2"  
300 x 600 x 50mm

## EDGE DETAILS



ROUNDED EDGE

## BUNDLE CONFIGURATION

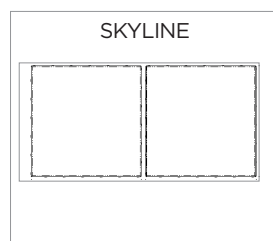

TECHNICAL INFORMATION

ASTM C 936 Standard Specifications for Solid Concrete Interlocking Paving Units



Conforms to:

- C140 for Absorption 5% avg - 7% max
- Compressive Strength > 7,200 PSI avg.
- C67 for Freeze-thaw Durability
- C418 for Abrasion Durability
- Dimensional Accuracy +/- 3mm

Test results available upon request

Meets the U.S. Architectural & Transportation Barrier Compliance Board Slip-Resistance Surfaces Advisory Guidelines

SOLAR REFLECTIVE INDEX (SRI) TESTING DETAILS

Product	Solar Reflectance	SRI
Grenada White - Umbriano Finish	0.45	52 
Opal Blend - Smooth Finish	0.32	34 

LEED INFORMATION

Materials & Resources: LEED V4:

- Building Product Disclosure and Optimization
- Sourcing of Raw Materials - Sourcing of Raw Materials and Extraction • 1 point
- Sourcing of Raw Materials - Leadership Extraction Practices • 1 point
- Material Ingredient Reporting - Material Ingredient Reporting • 1 point
- Material Ingredient Reporting - Material Ingredient Optimization • 1 point
- Environmental Product Declaration • 1 point

TECHNICAL ADVANTAGES

ENDURACOLOR™

Refined surface and long-lasting colour

CLASSIC

These products utilize a traditional product mix of large and small aggregates that's consistent from top to bottom with colour mixed throughout



Factory sealed for integral stain resistance

PRODUCT DATA

Stones & Bundling	Unit Thickness	SqFt Per				Per Bundle		Soldier LnFt Per			Sailor LnFt per			Units Per			Lbs Per		
		Bundle	Layer	Section	Stone	Layers	Section	Unit	Layer	Bundle	Unit	Layer	Bundle	SqFt	Layer	Bundle	Layer	Section	Bundle
Georgetown Manufacturing																			
12 x 24"	2" (50mm)	58.13	11.63	-	1.94	5	-	0.98	-	-	1.97	-	-	-	6	30	260.6	-	1,303
24 x 24"	2" (50mm)	38.75	7.75	-	3.88	5	-	1.97	3.94	19.7	1.97	3.94	19.7	0.26	-	10	174.80	-	874.00

Notes: Sold in full bundles only on a refundable skid. **Important: A urethane rubber paver mat must be used to prevent scuffing.** All measurements are nominal. For more information, samples or custom options, please contact your Unilock Territory Manager or call 1-800-UNILOCK.

APPLICATIONS



Pedestrian



Roof Deck



\*Wall pairing suggestion- U-CARA\*

RECOMMENDED SANDS

RECOMMENDED SEALER



Romex: Rompox® ECO-Fine  
Pedestrian Applications only

- | Ready mixed and easy to use
- | Resin film free
- | Resistant to ants, weeds, de-icing salts
- | Made from 98% natural, recycled or renewable raw materials
- | Pressure washer safe
- | Ideal for joint widths from 5mm (1/4")

Coverage:

Colour	5-6mm Joints
Beige, Stone Grey, Anthracite 55 lb bag / 1 kg can	125 sqft / 55 lb mix



Alliance Gator G2 MAXX Sand

- | Rain safe after 15 minutes (24hr no rain if concrete overlay)
- | Sets above 32° F/ 0° C - may vary depending on weather, drainage, bedding materials and installation
- | Dust free and haze free
- | Requires only one watering
- | Four colours: Beige, Grey, Black and Ivory

Coverage:

Colour	Narrow Joints	Wide Joints
Beige, Grey, Ivory 50 lb bag	65-85 sqft	22-42 sqft
Black 50 lb bag	58-76 sqft	20-38 sqft



Alliance Gator Hybrid Low Gloss + Colour Enhancer

- | Water-based
- | Low gloss finish
- | Vibrant Colour Enhancer
- | Rain safe after 24 hours

Coverage:

Size	Area
3.78 L / 1 U.S. gal.	200 sqft
18.9 L / 5.28 U.S. gal.	1,000 sqft

\*Please refer to Sands & Sealers on pages 190-202 for more detailed information.

Unsured of bonded vs. unbonded product recommendations? Please contact your Unilock Territory Manager for more information.

SLABS | SKYLINE™

SLABS

# SORENO™ SLAB

## ENDURACOLOR™

Exclusive to **UNILOCK**



LIGHT GRANITE



TOSCANA BEIGE

### VISUAL APPEARANCE

Smooth and elegant in appearance for a sleek and modern look.

### FINISH

Flamed-like texture made of fine-grained, natural stone grit.

### PRODUCT SPECIFICATIONS



**SLAB**  
16 x 32 x 2"  
400 x 800 x 50mm

### EDGE DETAILS



ROUNDED EDGE

\*Colour selection should be chosen from actual samples.





**TECHNICAL INFORMATION**

**ASTM C 936 Standard Specifications for Solid Concrete Interlocking Paving Units**

- Conforms to:
- C140 for Absorption 5% avg - 7% max
  - Compressive Strength > 7,200 PSI avg.
  - C67 for Freeze-thaw Durability
  - C418 for Abrasion Durability
  - Dimensional Accuracy **+/- 3mm**
- Test results available upon request*

**Meets the U.S. Architectural & Transportation Barrier Compliance Board Slip-Resistance Surfaces Advisory Guidelines**

**SOLAR REFLECTIVE INDEX (SRI) TESTING DETAILS**

Product	Solar Reflectance	SRI
Light Granite	0.44	50 
Toscana Beige	0.64	77 

**TECHNICAL ADVANTAGES**

**ENDURACOLOR™**

Refined surface and long-lasting colour



Factory sealed for integral stain resistance



Ultra-smooth surface texture

**LEED INFORMATION**

**Materials & Resources: LEED V4:**

- Building Product Disclosure and Optimization
- Sourcing of Raw Materials - Sourcing of Raw Materials and Extraction • **1 point**
- Sourcing of Raw Materials - Leadership Extraction Practices • **1 point**
- Material Ingredient Reporting - Material Ingredient Reporting • **1 point**
- Material Ingredient Reporting - Material Ingredient Optimization • **1 point**
- Environmental Product Declaration • **1 point**

**PRODUCT DATA**

Stones & Bundling	Unit	SqFt Per				Per Bundle		Soldier LnFt Per			Sailor LnFt per			Units Per			Lbs Per		
	Thickness	Bundle	Layer	Section	Stone	Layers	Section	Unit	Section	Bundle	Unit	Section	Bundle	SqFt	Layer	Bundle	Layer	Section	Bundle
<b>Chicago Manufacturing / Stocked in Ayr</b>																			
16 x 32"	2" (50mm)	64.27	3.57	-	3.57	18	-	1.34	-	24.04	2.67	-	48.13	0.28	1	18	164.78	-	2,965.95

Notes: Sold in full bundles only on a refundable skid. **Important: A urethane rubber paver mat must be used to prevent scuffing.** All measurements are nominal. For more information, samples or custom options, please contact your Unilock Territory Manager or call 1-800-UNILOCK.

**APPLICATIONS**



Pedestrian



Roof Deck



\*Wall pairing suggestion- U-CARA® Wall or Lineo™ Dimensional Stone

**RECOMMENDED SANDS**

**RECOMMENDED SEALER**



**Romex: Rompox® ECO-Fine**  
Pedestrian Applications only

- | Ready mixed and easy to use
- | Resin film free
- | Resistant to ants, weeds, de-icing salts
- | Made from 98% natural, recycled or renewable raw materials
- | Pressure washer safe
- | Ideal for joint widths from 5mm (1/4")

**Coverage:**

Colour	5-6mm Joints
Beige, Stone Grey, Anthracite 55 lb bag / 1 kg can	125 sqft / 55 lb mix



**Alliance Gator G2 MAXX Sand**

- | Rain safe after 15 minutes (24hr no rain if concrete overlay)
- | Sets above 32° F/ 0° C - may vary depending on weather, drainage, bedding materials and installation
- | Dust free and haze free
- | Requires only one watering
- | Four colours: Beige, Grey, Black and Ivory

**Coverage:**

Colour	Narrow Joints	Wide Joints
Beige, Grey, Ivory 50 lb bag	65-85 sqft	22-42 sqft
Black 50 lb bag	58-76 sqft	20-38 sqft



**Alliance Gator Hybrid Low Gloss + Colour Enhancer**

- | Water-based
- | Low gloss finish
- | Vibrant Colour Enhancer
- | Rain safe after 24 hours

**Coverage:**

Size	Area
3.78 L / 1 U.S. gal.	200 sqft
18.9 L / 5.28 U.S. gal.	1,000 sqft

\*Please refer to Sands & Sealers on pages 190-202 for more detailed information.

Unsure of bonded vs. unbonded product recommendations? Please contact your Unilock Territory Manager for more information.

# UMBRIANO<sup>®</sup> SLAB

Exclusive to **JNILOCK**



## ENDURACOLOR™



FRENCH GREY



GRENADA WHITE **NEW**  
Only available in 21 x 35 (60mm)



SUMMER WHEAT

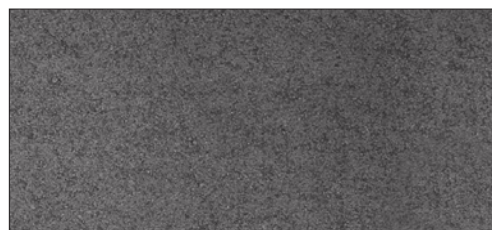

MIDNIGHT SKY  
Only available in 8x24 70mm



WINTER MARVEL

### VISUAL APPEARANCE

Granite-like surface appearance.

### FINISH

Subtly mottled colour and finish. Factory sealed to provide integral surface protection from stains.

### PRODUCT SPECIFICATIONS

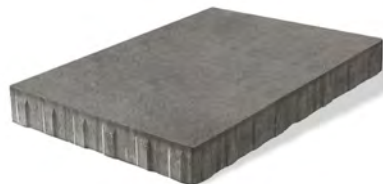

21 x 35 x 2<sup>3</sup>/<sub>8</sub>"  
540 x 890 x 60mm



8 x 24 x 2<sup>3</sup>/<sub>4</sub>"  
200 x 600 x 70mm



12 x 24 x 2<sup>3</sup>/<sub>4</sub>"  
300 x 600 x 70mm



24 x 24 x 2<sup>3</sup>/<sub>4</sub>"  
600 x 600 x 70mm

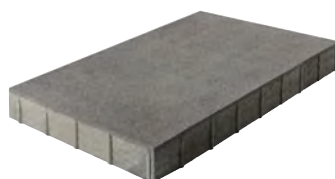

18 x 36 x 4"  
450 x 900 x 100mm

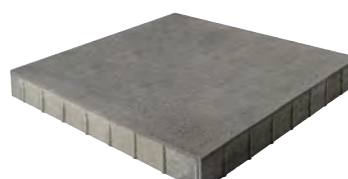

36 x 36 x 4"  
900 x 900 x 100mm

### EDGE DETAILS



ROUNDED EDGE  
100mm

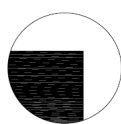

ZERO BEVEL EDGE  
60mm, 70mm &  
80mm

\*Colour selection should be chosen from actual samples.





**TECHNICAL INFORMATION**

**ASTM C936 Standard Specifications for Solid Concrete Interlocking Paving Units**

- Conforms to:
    - C140 for Absorption 5% avg - 7% max
    - Compressive Strength > 7,200 PSI avg.
    - C67 for Freeze-thaw Durability
    - C418 for Abrasion Durability
    - Dimensional Accuracy **+/- 3 mm**
- Test results available upon request*

**Meets the U.S. Architectural & Transportation Barrier Compliance Board Slip-Resistance Surfaces Advisory Guidelines**

**SOLAR REFLECTIVE INDEX (SRI) TESTING DETAILS**

Product	Solar Reflectance	SRI
Cream (custom)	0.45	52 
Grenada White	0.45	52 
Summer Wheat	0.42	48 
Winter Marvel	0.35	38 

**TECHNICAL ADVANTAGES**

**ENDURACOLOR™**

Refined surface and long-lasting colour



Factory sealed for integral stain resistance

**COLORFUSION™**

Subtly mottled colour finish

**PEDESTRIAN FRIENDLY**

Not recommended for vehicular loads

**LEED INFORMATION**

**Rainwater Management: LEED V4:**

- Up to three points can be achieved for retaining rainwater onsite based on the percentile kept
- 85% (zero lot line projects only) - 3 points, 95% - 2 points and 98% - 3 points. (All except Healthcare - subtract one point) See LEED v4 for more specific project/site details.

**Materials and Resources: LEED V4:**

- Building Product Disclosure and Optimization
- Sourcing of Raw Materials - Sourcing of Raw Materials and Extraction • **1 point**
- Sourcing of Raw Materials - Leadership Extraction Practices • **1 point**
- Material Ingredient Reporting - Material Ingredient Reporting • **1 point**
- Material Ingredient Reporting - Material Ingredient Optimization • **1 point**
- Environmental Product Declaration • **1 point**

**PRODUCT DATA**

Stones & Bundling	Unit		SqFt Per				Per Bundle		Soldier LnFt Per			Sailor LnFt per			Units Per			Lbs Per		
	Thickness		Bundle	Layer	Section	Stone	Layers	Sections	Unit	Layer	Bundle	Unit	Layer	Bundle	SqFt	Layer	Bundle	Layer	Section	Bundle
<b>Georgetown Manufacturing</b>																				
21" x 35"	2 3/8" (60mm)		62.76	10.46	-	5.23	6	-	1.77	-	21.26	2.95	-	35.43	0.19	2	12	287	-	1,722
8" x 24"	2 3/4" (70mm)		82.67	10.33	-	1.29	8	-	0.66	-	42.00	1.97	-	126.00	0.77	-	64	331	-	2,647
12" x 24"	2 3/4" (70mm)		93.00	11.63	-	1.94	8	-	0.98	-	47.20	1.97	-	94.50	0.52	-	48	393	-	3,142
24" x 24"	2 3/4" (70mm)		62.00	7.75	-	3.88	8	-	1.97	-	31.50	1.97	-	31.50	0.26	-	16	258	-	2,062
36" x 36"	4" (100mm)		43.59	8.72	-	8.72	5	-	2.95	-	14.80	2.95	-	14.80	-	1	5	398.9	-	1,994
18" x 36"	4" (100mm)		43.59	8.72	-	4.36	5	-	1.48	-	14.80	2.95	-	29.50	-	2	10	398.9	-	1,994

Notes: **24" and 60mm Random products are not intended for vehicular applications.** All measurements are nominal. **Sold in full bundles only** on a refundable skid. **Important: A urethane rubber paver mat must be used to prevent scuffing.** For more information, samples or custom options, please contact your Unilock Territory Manager or call 1-800-UNILOCK.

**APPLICATIONS**



Pedestrian



Roof Deck



\*Wall pairing suggestion- U-CARA® - matching colour and finish

**RECOMMENDED SANDS**

**RECOMMENDED SEALER**



**Romex: Rompox® ECO-Fine**  
Pedestrian Applications only  
Vehicular when laid on a Trass Bed

- | Ready mixed and easy to use
- | Resin film free
- | Resistant to ants, weeds, de-icing salts
- | Made from 98% natural, recycled or renewable raw materials
- | Pressure washer safe
- | Ideal for joint widths from 5mm (1/4")

**Coverage:**

Colour	5-6mm Joints
Beige, Stone Grey, Anthracite <i>55 lb bag / 1 kg can</i>	125 sqft / 55 lb mix



**Alliance Gator G2 MAXX Sand**

- | Rain safe after 15 minutes (24hr no rain if concrete overlay)
- | Sets above 32° F/ 0° C - may vary depending on weather, drainage, bedding materials and installation
- | Dust free and haze free
- | Requires only one watering
- | Four colours: Beige, Grey, Black and Ivory

**Coverage:**

Colour	Narrow Joints	Wide Joints
Beige, Grey, Ivory <i>50 lb bag</i>	65-85 sqft	22-42 sqft
Black <i>50 lb bag</i>	58-76 sqft	20-38 sqft



**Alliance Gator Hybrid Low Gloss + Colour Enhancer**

- | Water-based
- | Low gloss finish
- | Vibrant Colour Enhancer
- | Rain safe after 24 hours

**Coverage:**

Size	Area
3.78 L / 1 U.S. gal.	200 sqft
18.9 L / 5.28 U.S. gal.	1,000 sqft

*\*Please refer to Sands & Sealers on pages 190-202 for more detailed information.*

*Unsure of bonded vs. unbonded product recommendations? Please contact your Unilock Territory Manager for more information.*





INDIANA BUFF



STERLING

## VISUAL APPEARANCE

Large format slabs that pair well with many coping and U-Cara panel options to create a trendsetting, monochromatic design.

## FINISH

Smooth EnduraColor finish - subtly mottled colour and finish.

## PRODUCT SPECIFICATIONS



18 x 24 x 2 $\frac{3}{8}$ "  
450 x 600 x 60mm



18 x 36 x 2 $\frac{3}{8}$ "  
450 x 900 x 60mm



**BULLNOSE**  
19 x 36 x 2 $\frac{3}{8}$ "  
485 x 900 x 60mm

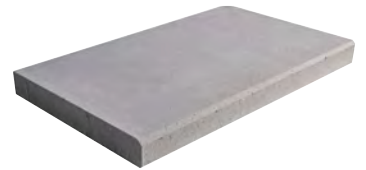

**CHAMFERED**  
19 x 36 x 2 $\frac{3}{8}$ "  
485 x 900 x 60mm

*Please see Steps, Treads and Coping section, page 170 for more details.*

## EDGE DETAILS



MICRO-BEVEL  
2mm

## BUNDLE CONFIGURATION

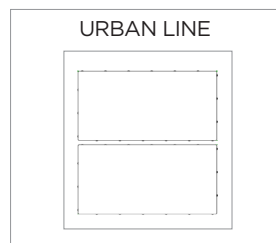

**TECHNICAL INFORMATION**

**ASTM C936 Standard Specifications for Solid Concrete Interlocking Paving Units**

Conforms to:

- C140 for Absorption 5% avg - 7% max
- Compressive Strength > 7,200 PSI avg.
- C67 for Freeze-thaw Durability
- C418 for Abrasion Durability
- Dimensional Accuracy +/- 3 mm

Test results available upon request

**Meets the U.S. Architectural & Transportation Barrier Compliance Board Slip-Resistance Surfaces Advisory Guidelines**

**LEED INFORMATION**

**Rainwater Management: LEED V4:**

- Up to three points can be achieved for retaining rainwater onsite based on the percentile kept
- 85% (zero lot line projects only) - 3 points, 95% - 2 points and 98% - 3 points. (All except Healthcare - subtract one point) See LEED v4 for more specific project/site details.

**Materials and Resources: LEED V4:**

Building Product Disclosure and Optimization

Sourcing of Raw Materials - Sourcing of Raw Materials and Extraction • 1 point

Sourcing of Raw Materials - Leadership Extraction Practices • 1 point

Material Ingredient Reporting - Material Ingredient Reporting • 1 point

Material Ingredient Reporting - Material Ingredient Optimization • 1 point

Environmental Product Declaration • 1 point

**TECHNICAL ADVANTAGES**

**ENDURACOLOR™**

Refined surface and long-lasting colour

**PRODUCT DATA**

Stones & Bundling	Unit	SqFt Per			Per Bundle	Soldier LnFt Per			Sailor LnFt per			Units Per			Lbs Per		
	Thickness	Bundle	Layer	Stone	Layers	Unit	Layer	Bundle	Unit	Layer	Bundle	SqFt	Section	Bundle	Layer	Section	Bundle
<b>Ayr Manufacturing</b>																	
18 x 24"	2 3/8" (60mm)	96.00	11.625	2.91	8	1.4765	5.906	35.44	0.68	7.874	47.244	0.68	-	32	319.05	-	2,552.41
18 x 36"	2 3/8" (60mm)	52.314	8.719	4.36	6	2.953	5.906	35.44	1.35	11.811	70.866	0.23	-	12	239.29	-	1,435.76

Notes: Product sold in full bundles only on a refundable skid. **Important: A urethane rubber paver mat must be used to prevent scuffing.** All measurements are nominal. For more information, samples or custom options, please contact your Unilock Territory Manager or call 1-800-UNILOCK.

**APPLICATIONS**



Pedestrian



Roof Deck



\*Wall pairing suggestion- U-CARA\*

**RECOMMENDED SANDS**

**RECOMMENDED SEALER**



**Romex: Rompox® ECO-Fine**

Pedestrian Applications only  
Vehicular when laid on a Trass Bed

- | Ready mixed and easy to use
- | Resin film free
- | Resistant to ants, weeds, de-icing salts
- | Made from 98% natural, recycled or renewable raw materials
- | Pressure washer safe
- | Ideal for joint widths from 5mm (1/4")

Coverage:

Colour	5-6mm Joints
Beige, Stone Grey, Anthracite 55 lb bag / 1 kg can	125 sqft / 55 lb mix



**Alliance Gator G2 MAXX Sand**

- | Rain safe after 15 minutes (24hr no rain if concrete overlay)
- | Sets above 32° F/ 0° C - may vary depending on weather, drainage, bedding materials and installation
- | Dust free and haze free
- | Requires only one watering
- | Four colours: Beige, Grey, Black and Ivory

Coverage:

Colour	Narrow Joints	Wide Joints
Beige, Grey, Ivory 50 lb bag	65-85 sqft	22-42 sqft
Black 50 lb bag	58-76 sqft	20-38 sqft



**Alliance Gator Hybrid Low Gloss + Colour Enhancer**

- | Water-based
- | Low gloss finish
- | Vibrant Colour Enhancer
- | Rain safe after 24 hours

Coverage:

Size	Area
3.78 L / 1 U.S. gal.	200 sqft
18.9 L / 5.28 U.S. gal.	1,000 sqft

\*Please refer to Sands & Sealers on pages 190-202 for more detailed information.

Unsured of bonded vs. unbonded product recommendations? Please contact your Unilock Territory Manager for more information.

# NATURAL STONE

TUSCAN BUCINE BLUESTONE - SANDSTONE

AVAILABLE WHILE QUANTITIES LAST



Exclusive to **JNILOCK**

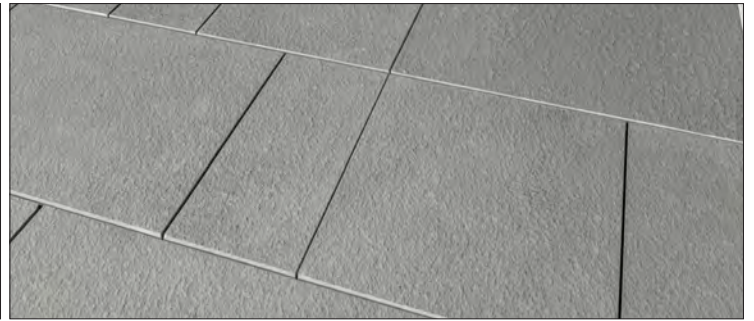
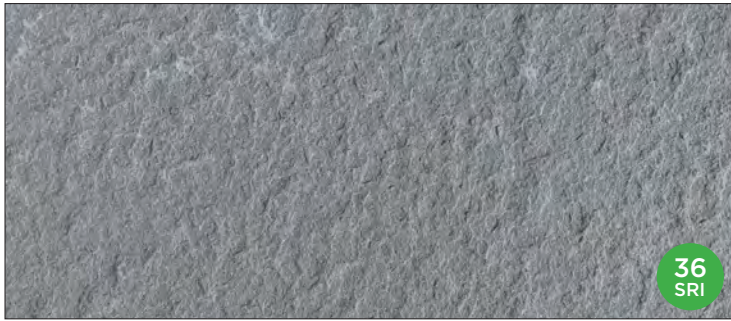

FLAMED SANDSTONE

Stone Type	Fine Grained Sedimentary Sandstone
Visual Appearance	Uniform Grey colour sandstone, flamed finish
Origin	Tuscany, Italy
Generic Stone Name	Pietra Extra Dura del Bucine
Age	Paleozoic (Carboniferous) 300 million years old
Finish	Sawn 6 sides, Flamed

## PRODUCT SPECIFICATIONS

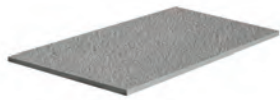

12 x 24 x 1½"  
300 x 600 x 38mm

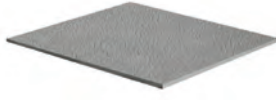

24 x 24 x 1½"  
600 x 600 x 38mm



24 x 36 x 1½"  
600 x 900 x 38mm



14 x 48 x 2"  
356 x 1200 x 50mm  
*See Steps, Treads & Coping section page 173 for more details*



24 x 24 x 2"  
600 x 600 x 50mm  
*See Steps, Treads & Coping section page 173 for more details*



**STEPS**  
24 x 48 x 6"  
600 x 1200 x 150mm  
*See Steps, Treads & Coping section page 180 for more details*



**U-CARA 6" FASCIA PANEL**  
6 x 9¼ x 2¾"  
150 x 233 x 60mm  
*See Retaining Walls & Vertical Features section page 154 for more details*

\*Colour selection should be chosen from actual samples.

LEED TESTING DETAILS

Testing Details	Mean
Water Absorbancy	1.09%
Apparent Density	2660 Kg/m <sup>3</sup>
Compressive Strength	133 Mpa
Modulus of Rupture	19.5 Mpa (17.3%)
Slip Resistance (When Wet)	69 SRV

SOLAR REFLECTIVE INDEX (SRI) TESTING DETAILS

Product	Solar Reflectance	SRI	Thermal Emittance
Bucine Bluestone	0.35	36 <span style="border: 1px solid green; border-radius: 50%; padding: 2px;">36 SRI</span>	0.87

TECHNICAL ADVANTAGES

PEDESTRIAN FRIENDLY

Not recommended for vehicular loads

PRODUCT DATA

Stones & Bundling	Unit Thickness	SqFt/ Crate	SqFt/ Stone	Units/ SqFt	Units/ Crates	Lbs/ Unit	Lbs/ Crate
12" x 24" (300 x 600mm)	1 1/2" (38mm)	168.00	2	0.50	84	24	2,016
24" x 24" (600 x 600mm)	1 1/2" (38mm)	176.00	4	0.25	44	48	2,112
24" x 36" (600 x 900mm)	1 1/2" (38mm)	168.00	6	0.17	28	72	2,016

For more information, samples or custom options, please contact your Unilock Territory Manager or call 1-800-UNILOCK.

*\*All Natural Stone is being stocked at our Barrie location.*

APPLICATIONS



Pedestrian



Roof Deck

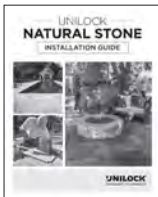

\*Contact your Unilock Territory Manager for installation best practices or visit [commercial.unilock.com](http://commercial.unilock.com) and refer to Natural Stone- Installation Guidelines.

[commercial.unilock.com/download/documents/technical-guides/](http://commercial.unilock.com/download/documents/technical-guides/)

RECOMMENDED SANDS



**Romex: Rompox<sup>®</sup> ECO-Fine**  
 Pedestrian Applications only  
 Vehicular when laid on a Trass Bed

- Ready mixed and easy to use
- Resin film free
- Resistant to ants, weeds, de-icing salts
- Made from 98% natural, recycled or renewable raw materials
- Pressure washer safe
- Ideal for joint widths from 5mm (1/4")

Coverage:

Colour	5-6mm Joints
Beige, Stone Grey, Anthracite 55 lb bag / 1 kg can	125 sqft / 55 lb mix



**Alliance Gator G2 MAXX Sand**

- Rain safe after 15 minutes (24hr no rain if concrete overlay)
- Sets above 32° F/ 0° C - may vary depending on weather, drainage, bedding materials and installation
- Dust free and haze free
- Requires only one watering
- Four colours: Beige, Grey, Black and Ivory

Coverage:

Colour	Narrow Joints	Wide Joints
Beige, Grey, Ivory 50 lb bag	65-85 sqft	22-42 sqft
Black 50 lb bag	58-76 sqft	20-38 sqft

RECOMMENDED GROUTS



**Ardex X32 Microtec (Thick bed mortar)**

- Mix with water only- easy to mix & apply
- Fast setting-grout tiles in 3 hours
- Ideal for moisture-sensitive stone
- Excellent sag resistance
- Coverage 40-80 sqft per bag, depending on size of trowel



**Ardex X90 Microtec (Thin bed mortar)**

- Highest levels
- Fast setting-grout tiles in 3 hours
- Ideal for moisture-sensitive stone
- Excellent sag resistance
- Coverage 40-80 sqft per bag, depending on size of trowel

RECOMMENDED SEALERS



**Unicare Natural Stone Matte Sealer**

- For porous stones, natural stone only
- No change of colour
- No surface coating, sheen or shine at all
- Riven Sandstone & Smooth Sandstone
- Coverage 6 m<sup>2</sup>/L depending on dilution



**Unicare Natural Stone Colour Enhancer Sealer**

- Colour enhancement for porous stones, natural stone only
- Breathable and easy to apply
- No surface coating, sheen or shine at all
- Riven Sandstone & Smooth Sandstone
- Coverage 6 m<sup>2</sup>/L depending on dilution

\*Please refer to Sands & Sealers on pages 190-202 for more detailed information.

Unsure of bonded vs. unbonded product recommendations? Please contact your Unilock Territory Manager for more information.

# NATURAL STONE

## BLACK RIVER - LIMESTONE

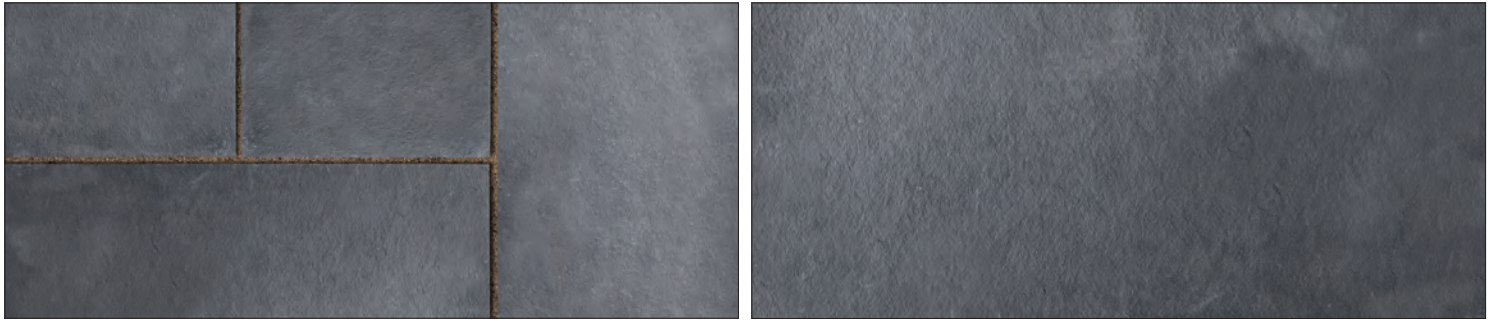

BLACK RIVER - LIMESTONE

Stone Type	Very Fine Grained Sedimentary Limestone
Visual Appearance	Predominantly charcoal grey to black
Origin	Kurnool, India
Generic Stone Name	Kadapha Black
Age	Neoproterozoic (Precambrian) 550 million years old
Finish	Naturally split, edge dressed & calibrated

### PRODUCT SPECIFICATIONS



12 x 24 x 7/8"  
300 x 600 x 22mm

24 x 24 x 7/8"  
600 x 600 x 22mm

24 x 36 x 7/8"  
600 x 900 x 22mm

See Steps, Treads & Coping section page 171 for Coping options and page 178 for Step options

### LEED TESTING DETAILS

Testing Details	Mean
Water Absorbancy	0.1%
Apparent Density	2699.27 kg/m <sup>3</sup>
Flexural Strength (when dry)	45.23 MPa
Flexural Strength (when wet)	46.47 MPa
Abrasion resistance	TBA
Slip Resistance (When Wet)	65

### SOLAR REFLECTIVE INDEX (SRI) TESTING DETAILS

Product	Solar Reflectance	Solar Absorptance	Thermal Emittance
Black River	0.08	0.92	0.90

\*Colour selection should be chosen from actual samples.



**TECHNICAL ADVANTAGES**

**PEDESTRIAN FRIENDLY**

Not recommended for vehicular loads

**PRODUCT DATA**

**Sandstone and Limestone Slab**

Stones & Bundling	Unit Thickness	SqFt/ Crate	SqFt/ Stone	Units/ SqFt	Units/ Crates	Lbs/ Unit	Lbs/ Crate
12" x 24" (300 x 600mm)	0.87" (22mm)	180	2	0.50	90	23.88	2,149.20
24" x 24" (600 x 600mm)	0.87" (22mm)	160	4	0.25	40	47.76	1,910.40
24" x 36" (600 x 900mm)	0.87" (22mm)	180	6	0.16667	30	71.64	2,149.20

For more information, samples or custom options, please contact your Unilock Territory Manager or call 1-800-UNILOCK.

*\*All Natural Stone is being stocked at our Barrie location.*

**APPLICATIONS**



Pedestrian





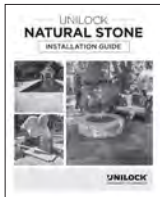



Roof Deck



\*Contact your Unilock Territory Manager for installation best practices or visit [commercial.unilock.com](http://commercial.unilock.com) and refer to Natural Stone- Installation Guidelines.

[commercial.unilock.com/download/documents/technical-guides/](http://commercial.unilock.com/download/documents/technical-guides/)

RECOMMENDED SANDS		RECOMMENDED GROUTS		RECOMMENDED SEALERS												
 <p><b>Romex: Rompox<sup>®</sup> ECO-Fine</b> Pedestrian Applications only Vehicular when laid on a Trass Bed</p> <ul style="list-style-type: none"> <li>Ready mixed and easy to use</li> <li>Resin film free</li> <li>Resistant to ants, weeds, de-icing salts</li> <li>Made from 98% natural, recycled or renewable raw materials</li> <li>Pressure washer safe</li> <li>Ideal for joint widths from 5mm (1/4")</li> </ul> <p>Coverage:</p> <table border="1"> <thead> <tr> <th>Colour</th> <th>5-6mm Joints</th> </tr> </thead> <tbody> <tr> <td>Beige, Stone Grey, Anthracite 55 lb bag / 1 kg can</td> <td>125 sqft / 55 lb mix</td> </tr> </tbody> </table>	Colour	5-6mm Joints	Beige, Stone Grey, Anthracite 55 lb bag / 1 kg can	125 sqft / 55 lb mix	 <p><b>Alliance Gator G2 MAXX Sand</b></p> <ul style="list-style-type: none"> <li>Rain safe after 15 minutes (24hr no rain if concrete overlay)</li> <li>Sets above 32° F/ 0° C - may vary depending on weather, drainage, bedding materials and installation</li> <li>Dust free and haze free</li> <li>Requires only one watering</li> <li>Four colours: Beige, Grey, Black and Ivory</li> </ul> <p>Coverage:</p> <table border="1"> <thead> <tr> <th>Colour</th> <th>Narrow Joints</th> <th>Wide Joints</th> </tr> </thead> <tbody> <tr> <td>Beige, Grey, Ivory 50 lb bag</td> <td>65-85 sqft</td> <td>22-42 sqft</td> </tr> <tr> <td>Black 50 lb bag</td> <td>58-76 sqft</td> <td>20-38 sqft</td> </tr> </tbody> </table>	Colour	Narrow Joints	Wide Joints	Beige, Grey, Ivory 50 lb bag	65-85 sqft	22-42 sqft	Black 50 lb bag	58-76 sqft	20-38 sqft	 <p><b>Ardex X32 Microtec</b> (Thick bed mortar)</p> <ul style="list-style-type: none"> <li>Mix with water only- easy to mix &amp; apply</li> <li>Fast setting-grout tiles in 3 hours</li> <li>Ideal for moisture-sensitive stone</li> <li>Excellent sag resistance</li> <li>Coverage 40-80 sqft per bag, depending on size of trowel</li> </ul>  <p><b>Ardex X90 Microtec</b> (Thin bed mortar)</p> <ul style="list-style-type: none"> <li>Highest levels</li> <li>Fast setting-grout tiles in 3 hours</li> <li>Ideal for moisture-sensitive stone</li> <li>Excellent sag resistance</li> <li>Coverage 40-80 sqft per bag, depending on size of trowel</li> </ul>	 <p><b>Unicare Natural Stone Matte Sealer</b></p> <ul style="list-style-type: none"> <li>For porous stones, natural stone only</li> <li>No change of colour</li> <li>No surface coating, sheen or shine at all</li> <li>Riven Sandstone &amp; Smooth Sandstone</li> <li>Coverage 6 m<sup>2</sup>/L depending on dilution</li> </ul>  <p><b>Unicare Natural Stone Colour Enhancer Sealer</b></p> <ul style="list-style-type: none"> <li>Colour enhancement for porous stones, natural stone only</li> <li>Breathable and easy to apply</li> <li>No surface coating, sheen or shine at all</li> <li>Riven Sandstone &amp; Smooth Sandstone</li> <li>Coverage 6 m<sup>2</sup>/L depending on dilution</li> </ul>
Colour	5-6mm Joints															
Beige, Stone Grey, Anthracite 55 lb bag / 1 kg can	125 sqft / 55 lb mix															
Colour	Narrow Joints	Wide Joints														
Beige, Grey, Ivory 50 lb bag	65-85 sqft	22-42 sqft														
Black 50 lb bag	58-76 sqft	20-38 sqft														

\*Please refer to Sands & Sealers on pages 190-202 for more detailed information.

Unsure of bonded vs. unbonded product recommendations? Please contact your Unilock Territory Manager for more information.

# NATURAL STONE

## GREYFIELD - SANDSTONE



GREYFIELD - SANDSTONE

<b>Stone Type</b>	<b>Fine Grained Sedimentary Sandstone</b>
Visual Appearance	Soft grey with gentle veining
Origin	Rajasthan, India
Generic Stone Name	Hemnivas
Age	Neoproterozoic (Precambrian) 550 million years old
Finish	Sawn Six sides, Flamed & Diamond brushed

### PRODUCT SPECIFICATIONS



12 x 24 x 7/8"  
300 x 600 x 22mm



24 x 24 x 7/8"  
600 x 600 x 22mm



24 x 36 x 7/8"  
600 x 900 x 22mm

See Steps, Treads & Coping section page 172 for Coping options and page 179 for Step options

*18" x 24" x 7/8" (22mm) is available while quantities last.*

### LEED TESTING DETAILS

Testing Details	Mean
Water Absorbancy	1.4%
Apparent Density	2600 kg/m <sup>3</sup>
Flexural Strength (when dry)	35.92 MPa
Flexural Strength (when wet)	27.10 MPa
Abrasion resistance	101.1%
Slip Resistance (When Wet)	0.75

### SOLAR REFLECTIVE INDEX (SRI) TESTING DETAILS

Product	Solar Reflectance	Solar Absorptance	Thermal Emittance
Greyfield	0.32	0.68	0.90

\*Colour selection should be chosen from actual samples.

**TECHNICAL ADVANTAGES**

**PEDESTRIAN FRIENDLY**

Not recommended for vehicular loads

**PRODUCT DATA**

**Sandstone Slab**

Stones & Bundling	Unit Thickness	SqFt/ Crate	SqFt/ Stone	Units/ SqFt	Units/ Crates	Lbs/ Unit	Lbs/ Crate
12 x 24" (300 x 600mm)	0.87" (22mm)	180	2	0.50	90	23.88	2,149
24 x 24" (600 x 600mm)	0.87" (22mm)	160	4	0.25	40	47.76	1,910.40
24 x 36" (600 x 900mm)	0.87" (22mm)	180	6	0.17	30	71.64	2,149.20

For more information, samples or custom options, please contact your Unilock Territory Manager or call 1-800-UNILOCK.

*\*All Natural Stone is being stocked at our Barrie location.*

**APPLICATIONS**



Pedestrian





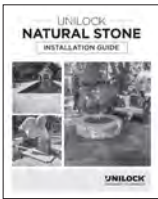



Roof Deck



\*Contact your Unilock Territory Manager for installation best practices or visit [commercial.unilock.com](http://commercial.unilock.com) and refer to Natural Stone- Installation Guidelines.

[commercial.unilock.com/download/documents/technical-guides/](http://commercial.unilock.com/download/documents/technical-guides/)

RECOMMENDED SANDS		RECOMMENDED GROUTS		RECOMMENDED SEALERS												
 <p><b>Romex: Rompox<sup>®</sup> ECO-Fine</b> Pedestrian Applications only Vehicular when laid on a Trass Bed</p> <ul style="list-style-type: none"> <li>Ready mixed and easy to use</li> <li>Resin film free</li> <li>Resistant to ants, weeds, de-icing salts</li> <li>Made from 98% natural, recycled or renewable raw materials</li> <li>Pressure washer safe</li> <li>Ideal for joint widths from 5mm (1/4")</li> </ul> <p>Coverage:</p> <table border="1"> <thead> <tr> <th>Colour</th> <th>5-6mm Joints</th> </tr> </thead> <tbody> <tr> <td>Beige, Stone Grey, Anthracite 55 lb bag / 1 kg can</td> <td>125 sqft / 55 lb mix</td> </tr> </tbody> </table>	Colour	5-6mm Joints	Beige, Stone Grey, Anthracite 55 lb bag / 1 kg can	125 sqft / 55 lb mix	 <p><b>Alliance Gator G2 MAXX Sand</b></p> <ul style="list-style-type: none"> <li>Rain safe after 15 minutes (24hr no rain if concrete overlay)</li> <li>Sets above 32° F/ 0° C - may vary depending on weather, drainage, bedding materials and installation</li> <li>Dust free and haze free</li> <li>Requires only one watering</li> <li>Four colours: Beige, Grey, Black and Ivory</li> </ul> <p>Coverage:</p> <table border="1"> <thead> <tr> <th>Colour</th> <th>Narrow Joints</th> <th>Wide Joints</th> </tr> </thead> <tbody> <tr> <td>Beige, Grey, Ivory 50 lb bag</td> <td>65-85 sqft</td> <td>22-42 sqft</td> </tr> <tr> <td>Black 50 lb bag</td> <td>58-76 sqft</td> <td>20-38 sqft</td> </tr> </tbody> </table>	Colour	Narrow Joints	Wide Joints	Beige, Grey, Ivory 50 lb bag	65-85 sqft	22-42 sqft	Black 50 lb bag	58-76 sqft	20-38 sqft	 <p><b>Ardex X32 Microtec (Thick bed mortar)</b></p> <ul style="list-style-type: none"> <li>Mix with water only- easy to mix &amp; apply</li> <li>Fast setting-grout tiles in 3 hours</li> <li>Ideal for moisture-sensitive stone</li> <li>Excellent sag resistance</li> <li>Coverage 40-80 sqft per bag, depending on size of trowel</li> </ul>  <p><b>Ardex X90 Microtec (Thin bed mortar)</b></p> <ul style="list-style-type: none"> <li>Highest levels</li> <li>Fast setting-grout tiles in 3 hours</li> <li>Ideal for moisture-sensitive stone</li> <li>Excellent sag resistance</li> <li>Coverage 40-80 sqft per bag, depending on size of trowel</li> </ul>	 <p><b>Unicare Natural Stone Matte Sealer</b></p> <ul style="list-style-type: none"> <li>For porous stones, natural stone only</li> <li>No change of colour</li> <li>No surface coating, sheen or shine at all</li> <li>Riven Sandstone &amp; Smooth Sandstone</li> <li>Coverage 6 m<sup>2</sup>/L depending on dilution</li> </ul>  <p><b>Unicare Natural Stone Colour Enhancer Sealer</b></p> <ul style="list-style-type: none"> <li>Colour enhancement for porous stones, natural stone only</li> <li>Breathable and easy to apply</li> <li>No surface coating, sheen or shine at all</li> <li>Riven Sandstone &amp; Smooth Sandstone</li> <li>Coverage 6 m<sup>2</sup>/L depending on dilution</li> </ul>
Colour	5-6mm Joints															
Beige, Stone Grey, Anthracite 55 lb bag / 1 kg can	125 sqft / 55 lb mix															
Colour	Narrow Joints	Wide Joints														
Beige, Grey, Ivory 50 lb bag	65-85 sqft	22-42 sqft														
Black 50 lb bag	58-76 sqft	20-38 sqft														

\*Please refer to Sands & Sealers on pages 190-202 for more detailed information.

Unsure of bonded vs. unbonded product recommendations? Please contact your Unilock Territory Manager for more information.

# NATURAL STONE

## INDIAN COAST - SANDSTONE

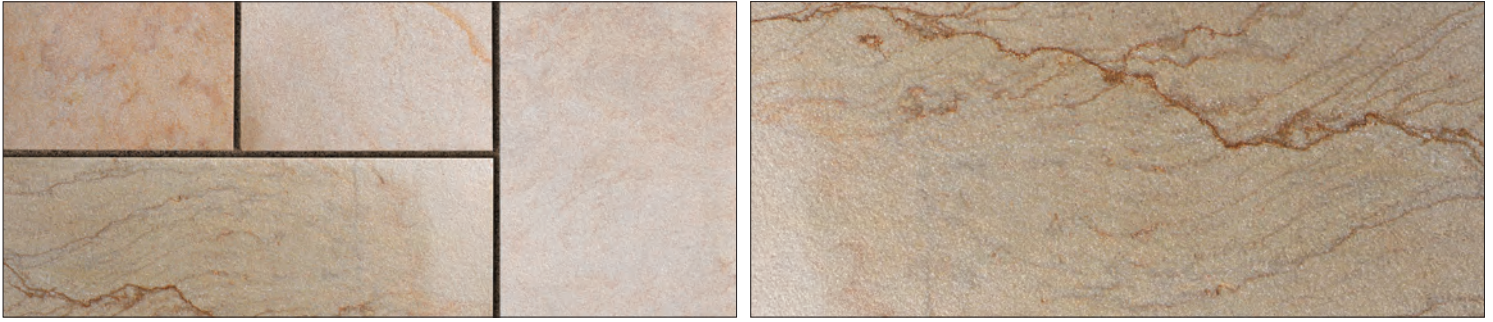

### INDIAN COAST - SANDSTONE

Stone Type	Fine Grained Sedimentary Sandstone
Visual Appearance	White & cream to light pink. Light brown veining with very faint, slightly wavy bedding lines
Origin	Rajasthan, India
Generic Stone Name	Boondi White
Age	Neoproterozoic (Precambrian) 550 million years old
Finish	Sawn Six sides, Shot Blasted & Brushed

### PRODUCT SPECIFICATIONS



12 x 24 x 7/8"  
300 x 600 x 22mm

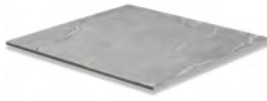

24 x 24 x 7/8"  
600 x 600 x 22mm



24 x 36 x 7/8"  
600 x 900 x 22mm

See Steps, Treads & Coping section page 172 for Coping options and page 179 for Step options

18" x 24" x 7/8" (22mm) is available while quantities last.

### LEED TESTING DETAILS

Testing Details	Mean
Water Absorbancy	1.2%
Apparent Density	2550 kg/m <sup>3</sup>
Flexural Strength (when dry)	30.96 MPa
Flexural Strength (when wet)	24.13 MPa
Abrasion resistance	116.4%
Slip Resistance (When Wet)	80

### SOLAR REFLECTIVE INDEX (SRI) TESTING DETAILS

Product	Solar Reflectance	Solar Absorptance	Thermal Emittance
Indian Coast	0.48	0.52	0.90

\*Colour selection should be chosen from actual samples.

**TECHNICAL ADVANTAGES**

**PEDESTRIAN FRIENDLY**

Not recommended for vehicular loads

**PRODUCT DATA**

**Sandstone and Limestone Slab**

Stones & Bundling	Unit Thickness	SqFt/ Crate	SqFt/ Stone	Units/ SqFt	Units/ Crates	Lbs/ Unit	Lbs/ Crate
12" x 24" (300 x 600mm)	0.87" (22mm)	180	2	0.50	90	23.88	2,149.20
24" x 24" (600 x 600mm)	0.87" (22mm)	160	4	0.25	40	47.76	1,910.40
24" x 36" (600 x 900mm)	0.87" (22mm)	180	6	0.17	30	71.64	2,149.20

For more information, samples or custom options, please contact your Unilock Territory Manager or call 1-800-UNILOCK.

*\*All Natural Stone is being stocked at our Barrie location.*

**APPLICATIONS**



Pedestrian





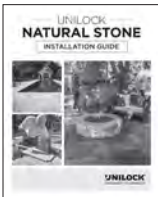



Roof Deck



\*Contact your Unilock Territory Manager for installation best practices or visit [commercial.unilock.com](http://commercial.unilock.com) and refer to Natural Stone- Installation Guidelines.

[commercial.unilock.com/download/documents/technical-guides/](http://commercial.unilock.com/download/documents/technical-guides/)

RECOMMENDED SANDS		RECOMMENDED GROUTS		RECOMMENDED SEALERS												
 <p><b>Romex: Rompox<sup>®</sup> ECO-Fine</b> Pedestrian Applications only Vehicular when laid on a Trass Bed</p> <ul style="list-style-type: none"> <li>Ready mixed and easy to use</li> <li>Resin film free</li> <li>Resistant to ants, weeds, de-icing salts</li> <li>Made from 98% natural, recycled or renewable raw materials</li> <li>Pressure washer safe</li> <li>Ideal for joint widths from 5mm (1/4")</li> </ul> <p>Coverage:</p> <table border="1"> <thead> <tr> <th>Colour</th> <th>5-6mm Joints</th> </tr> </thead> <tbody> <tr> <td>Beige, Stone Grey, Anthracite 55 lb bag / 1 kg can</td> <td>125 sqft / 55 lb mix</td> </tr> </tbody> </table>	Colour	5-6mm Joints	Beige, Stone Grey, Anthracite 55 lb bag / 1 kg can	125 sqft / 55 lb mix	 <p><b>Alliance Gator G2 MAXX Sand</b></p> <ul style="list-style-type: none"> <li>Rain safe after 15 minutes (24hr no rain if concrete overlay)</li> <li>Sets above 32° F/ 0° C - may vary depending on weather, drainage, bedding materials and installation</li> <li>Dust free and haze free</li> <li>Requires only one watering</li> <li>Four colours: Beige, Grey, Black and Ivory</li> </ul> <p>Coverage:</p> <table border="1"> <thead> <tr> <th>Colour</th> <th>Narrow Joints</th> <th>Wide Joints</th> </tr> </thead> <tbody> <tr> <td>Beige, Grey, Ivory 50 lb bag</td> <td>65-85 sqft</td> <td>22-42 sqft</td> </tr> <tr> <td>Black 50 lb bag</td> <td>58-76 sqft</td> <td>20-38 sqft</td> </tr> </tbody> </table>	Colour	Narrow Joints	Wide Joints	Beige, Grey, Ivory 50 lb bag	65-85 sqft	22-42 sqft	Black 50 lb bag	58-76 sqft	20-38 sqft	 <p><b>Ardex X32 Microtec (Thick bed mortar)</b></p> <ul style="list-style-type: none"> <li>Mix with water only- easy to mix &amp; apply</li> <li>Fast setting-grout tiles in 3 hours</li> <li>Ideal for moisture-sensitive stone</li> <li>Excellent sag resistance</li> <li>Coverage 40-80 sqft per bag, depending on size of trowel</li> </ul>  <p><b>Ardex X90 Microtec (Thin bed mortar)</b></p> <ul style="list-style-type: none"> <li>Highest levels</li> <li>Fast setting-grout tiles in 3 hours</li> <li>Ideal for moisture-sensitive stone</li> <li>Excellent sag resistance</li> <li>Coverage 40-80 sqft per bag, depending on size of trowel</li> </ul>	 <p><b>Unicare Natural Stone Matte Sealer</b></p> <ul style="list-style-type: none"> <li>For porous stones, natural stone only</li> <li>No change of colour</li> <li>No surface coating, sheen or shine at all</li> <li>Riven Sandstone &amp; Smooth Sandstone</li> <li>Coverage 6 m<sup>2</sup>/L depending on dilution</li> </ul>  <p><b>Unicare Natural Stone Colour Enhancer Sealer</b></p> <ul style="list-style-type: none"> <li>Colour enhancement for porous stones, natural stone only</li> <li>Breathable and easy to apply</li> <li>No surface coating, sheen or shine at all</li> <li>Riven Sandstone &amp; Smooth Sandstone</li> <li>Coverage 6 m<sup>2</sup>/L depending on dilution</li> </ul>
Colour	5-6mm Joints															
Beige, Stone Grey, Anthracite 55 lb bag / 1 kg can	125 sqft / 55 lb mix															
Colour	Narrow Joints	Wide Joints														
Beige, Grey, Ivory 50 lb bag	65-85 sqft	22-42 sqft														
Black 50 lb bag	58-76 sqft	20-38 sqft														

\*Please refer to Sands & Sealers on pages 190-202 for more detailed information.

Unsure of bonded vs. unbonded product recommendations? Please contact your Unilock Territory Manager for more information.

# NATURAL STONE

## IVORY SAND - SANDSTONE

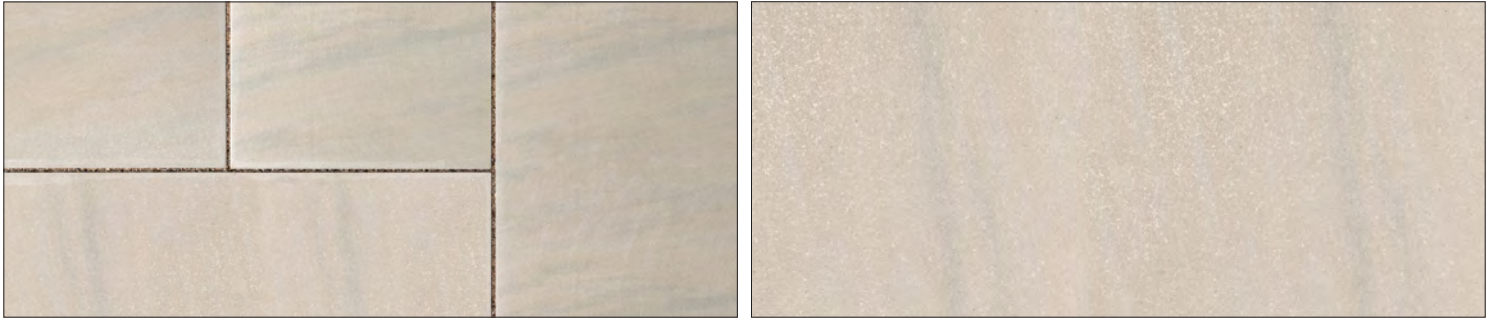

IVORY SAND - SANDSTONE

Stone Type	Fine Grained Sedimentary Sandstone
Visual Appearance	White & cream. Greyish veining with very faint, slightly wavy bedding lines
Origin	Rajasthan, India
Age	Neoproterozoic (Precambrian) 550 million years old
Finish	Sawn Six sides, Shot Blasted & Brushed

### PRODUCT SPECIFICATIONS



12 x 24 x 7/8"  
300 x 600 x 22mm

24 x 24 x 7/8"  
600 x 600 x 22mm

24 x 36 x 7/8"  
600 x 900 x 22mm

See Steps, Treads & Coping section page 172 for Coping options and page 179 for Step options

### LEED TESTING DETAILS

Testing Details	Mean
Water Absorbancy	1.2%
Apparent Density	2550 kg/m <sup>3</sup>
Flextural Strength (when dry)	30.96 MPa
Flextural Strength (when wet)	24.13 MPa
Abrasion resistance	116.4%
Slip Resistance (When Wet)	80

### SOLAR REFLECTIVE INDEX (SRI) TESTING DETAILS

Product	Solar Reflectance	Solar Absorptance	Thermal Emittance
Ivory Sand	0.48	0.52	0.90

\*Colour selection should be chosen from actual samples.

**TECHNICAL ADVANTAGES**

**PEDESTRIAN FRIENDLY**

Not recommended for vehicular loads

**PRODUCT DATA**

**Sandstone and Limestone Slab**

Stones & Bundling	Unit Thickness	SqFt/ Crate	SqFt/ Stone	Units/ SqFt	Units/ Crates	Lbs/ Unit	Lbs/ Crate
12" x 24" (300 x 600mm)	0.87" (22mm)	180	2	0.50	90	23.88	2,149.20
24" x 24" (600 x 600mm)	0.87" (22mm)	160	4	0.25	40	47.76	1,910.40
24" x 36" (600 x 900mm)	0.87" (22mm)	180	6	0.17	30	71.64	2,149.20

For more information, samples or custom options, please contact your Unilock Territory Manager or call 1-800-UNILOCK.

*\*All Natural Stone is being stocked at our Barrie location.*

**APPLICATIONS**



Pedestrian





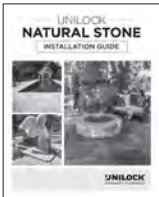



Roof Deck



\*Contact your Unilock Territory Manager for installation best practices or visit [commercial.unilock.com](http://commercial.unilock.com) and refer to Natural Stone- Installation Guidelines.

[commercial.unilock.com/download/documents/technical-guides/](http://commercial.unilock.com/download/documents/technical-guides/)

RECOMMENDED SANDS		RECOMMENDED GROUTS		RECOMMENDED SEALERS												
 <p><b>Romex: Rompox<sup>®</sup> ECO-Fine</b> Pedestrian Applications only Vehicular when laid on a Trass Bed</p> <ul style="list-style-type: none"> <li>Ready mixed and easy to use</li> <li>Resin film free</li> <li>Resistant to ants, weeds, de-icing salts</li> <li>Made from 98% natural, recycled or renewable raw materials</li> <li>Pressure washer safe</li> <li>Ideal for joint widths from 5mm (1/4")</li> </ul> <p>Coverage:</p> <table border="1"> <thead> <tr> <th>Colour</th> <th>5-6mm Joints</th> </tr> </thead> <tbody> <tr> <td>Beige, Stone Grey, Anthracite <i>55 lb bag / 1 kg can</i></td> <td>125 sqft / 55 lb mix</td> </tr> </tbody> </table>	Colour	5-6mm Joints	Beige, Stone Grey, Anthracite <i>55 lb bag / 1 kg can</i>	125 sqft / 55 lb mix	 <p><b>Alliance Gator G2 MAXX Sand</b></p> <ul style="list-style-type: none"> <li>Rain safe after 15 minutes (24hr no rain if concrete overlay)</li> <li>Sets above 32° F/ 0° C - may vary depending on weather, drainage, bedding materials and installation</li> <li>Dust free and haze free</li> <li>Requires only one watering</li> <li>Four colours: Beige, Grey, Black and Ivory</li> </ul> <p>Coverage:</p> <table border="1"> <thead> <tr> <th>Colour</th> <th>Narrow Joints</th> <th>Wide Joints</th> </tr> </thead> <tbody> <tr> <td>Beige, Grey, Ivory <i>50 lb bag</i></td> <td>65-85 sqft</td> <td>22-42 sqft</td> </tr> <tr> <td>Black <i>50 lb bag</i></td> <td>58-76 sqft</td> <td>20-38 sqft</td> </tr> </tbody> </table>	Colour	Narrow Joints	Wide Joints	Beige, Grey, Ivory <i>50 lb bag</i>	65-85 sqft	22-42 sqft	Black <i>50 lb bag</i>	58-76 sqft	20-38 sqft	 <p><b>Ardex X32 Microtec</b> (<i>Thick bed mortar</i>)</p> <ul style="list-style-type: none"> <li>Mix with water only- easy to mix &amp; apply</li> <li>Fast setting-grout tiles in 3 hours</li> <li>Ideal for moisture-sensitive stone</li> <li>Excellent sag resistance</li> <li>Coverage 40-80 sqft per bag, depending on size of trowel</li> </ul>  <p><b>Ardex X90 Microtec</b> (<i>Thin bed mortar</i>)</p> <ul style="list-style-type: none"> <li>Highest levels</li> <li>Fast setting-grout tiles in 3 hours</li> <li>Ideal for moisture-sensitive stone</li> <li>Excellent sag resistance</li> <li>Coverage 40-80 sqft per bag, depending on size of trowel</li> </ul>	 <p><b>Unicare Natural Stone Matte Sealer</b></p> <ul style="list-style-type: none"> <li>For porous stones, natural stone only</li> <li>No change of colour</li> <li>No surface coating, sheen or shine at all</li> <li>Riven Sandstone &amp; Smooth Sandstone</li> <li>Coverage 6 m<sup>2</sup>/L depending on dilution</li> </ul>  <p><b>Unicare Natural Stone Colour Enhancer Sealer</b></p> <ul style="list-style-type: none"> <li>Colour enhancement for porous stones, natural stone only</li> <li>Breathable and easy to apply</li> <li>No surface coating, sheen or shine at all</li> <li>Riven Sandstone &amp; Smooth Sandstone</li> <li>Coverage 6 m<sup>2</sup>/L depending on dilution</li> </ul>
Colour	5-6mm Joints															
Beige, Stone Grey, Anthracite <i>55 lb bag / 1 kg can</i>	125 sqft / 55 lb mix															
Colour	Narrow Joints	Wide Joints														
Beige, Grey, Ivory <i>50 lb bag</i>	65-85 sqft	22-42 sqft														
Black <i>50 lb bag</i>	58-76 sqft	20-38 sqft														

\*Please refer to Sands & Sealers on pages 190-202 for more detailed information.

Unsured of bonded vs. unbonded product recommendations? Please contact your Unilock Territory Manager for more information.

# NATURAL STONE

## STONE CLIFF GREY - SANDSTONE



STONE CLIFF GREY - SANDSTONE

Stone Type	Fine Grained Sedimentary Sandstone
Visual Appearance	White & grey. Dark grey veining with very faint, slightly wavy bedding lines
Origin	Rajasthan, India
Generic Stone Name	Hemnivas
Age	Neoproterozoic (Precambrian) 550 million years old
Finish	Naturally split, edge dressed & calibrated

### PRODUCT SPECIFICATIONS



12 x 24 x 7/8"  
300 x 600 x 22mm

24 x 24 x 7/8"  
600 x 600 x 22mm

24 x 36 x 7/8"  
600 x 900 x 22mm

See Steps, Treads & Coping section page 172 for Coping options and page 179 for Step options

*18" x 24" x 7/8" (22mm) is available while quantities last.*

### LEED TESTING DETAILS

Testing Details	Mean
Water Absorbancy	1.4%
Apparent Density	2600 kg/m <sup>3</sup>
Flexural Strength (when dry)	35.92 MPa
Flexural Strength (when wet)	25.10 MPa
Abrasion resistance	101.1%
Slip Resistance (When Wet)	0.75

### SOLAR REFLECTIVE INDEX (SRI) TESTING DETAILS

Product	Solar Reflectance	Solar Absorptance	Thermal Emittance
Stone Cliff Grey	0.27	0.73	0.91

\*Colour selection should be chosen from actual samples.



**TECHNICAL ADVANTAGES**

**PEDESTRIAN FRIENDLY**

Not recommended for vehicular loads

**PRODUCT DATA**

**Sandstone and Limestone Slab**

Stones & Bundling	Unit Thickness	SqFt/ Crate	SqFt/ Stone	Units/ SqFt	Units/ Crates	Lbs/ Unit	Lbs/ Crate
12" x 24" (300 x 600mm)	0.87" (22mm)	180	2	0.50	90	23.88	2,149.20
24" x 24" (600 x 600mm)	0.87" (22mm)	160	4	0.25	40	47.76	1,910.40
24" x 36" (600 x 900mm)	0.87" (22mm)	180	6	0.17	30	71.64	2,149.20

For more information, samples or custom options, please contact your Unilock Territory Manager or call 1-800-UNILOCK.

*\*All Natural Stone is being stocked at our Barrie location.*

**APPLICATIONS**



Pedestrian





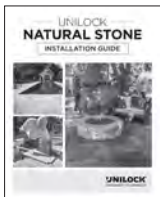



Roof Deck



\*Contact your Unilock Territory Manager for installation best practices or visit [commercial.unilock.com](http://commercial.unilock.com) and refer to Natural Stone- Installation Guidelines.

[commercial.unilock.com/download/documents/technical-guides/](http://commercial.unilock.com/download/documents/technical-guides/)

RECOMMENDED SANDS		RECOMMENDED GROUTS		RECOMMENDED SEALERS												
 <p><b>Romex: Rompox<sup>®</sup> ECO-Fine</b> Pedestrian Applications only Vehicular when laid on a Trass Bed</p> <ul style="list-style-type: none"> <li>Ready mixed and easy to use</li> <li>Resin film free</li> <li>Resistant to ants, weeds, de-icing salts</li> <li>Made from 98% natural, recycled or renewable raw materials</li> <li>Pressure washer safe</li> <li>Ideal for joint widths from 5mm (1/4")</li> </ul> <p><b>Coverage:</b></p> <table border="1"> <thead> <tr> <th>Colour</th> <th>5-6mm Joints</th> </tr> </thead> <tbody> <tr> <td>Beige, Stone Grey, Anthracite 55 lb bag / 1 kg can</td> <td>125 sqft / 55 lb mix</td> </tr> </tbody> </table>	Colour	5-6mm Joints	Beige, Stone Grey, Anthracite 55 lb bag / 1 kg can	125 sqft / 55 lb mix	 <p><b>Alliance Gator G2 MAXX Sand</b></p> <ul style="list-style-type: none"> <li>Rain safe after 15 minutes (24hr no rain if concrete overlay)</li> <li>Sets above 32° F/ 0° C - may vary depending on weather, drainage, bedding materials and installation</li> <li>Dust free and haze free</li> <li>Requires only one watering</li> <li>Four colours: Beige, Grey, Black and Ivory</li> </ul> <p><b>Coverage:</b></p> <table border="1"> <thead> <tr> <th>Colour</th> <th>Narrow Joints</th> <th>Wide Joints</th> </tr> </thead> <tbody> <tr> <td>Beige, Grey, Ivory 50 lb bag</td> <td>65-85 sqft</td> <td>22-42 sqft</td> </tr> <tr> <td>Black 50 lb bag</td> <td>58-76 sqft</td> <td>20-38 sqft</td> </tr> </tbody> </table>	Colour	Narrow Joints	Wide Joints	Beige, Grey, Ivory 50 lb bag	65-85 sqft	22-42 sqft	Black 50 lb bag	58-76 sqft	20-38 sqft	 <p><b>Ardex X32 Microtec</b> (Thick bed mortar)</p> <ul style="list-style-type: none"> <li>Mix with water only- easy to mix &amp; apply</li> <li>Fast setting-grout tiles in 3 hours</li> <li>Ideal for moisture-sensitive stone</li> <li>Excellent sag resistance</li> <li>Coverage 40-80 sqft per bag, depending on size of trowel</li> </ul>  <p><b>Ardex X90 Microtec</b> (Thin bed mortar)</p> <ul style="list-style-type: none"> <li>Highest levels</li> <li>Fast setting-grout tiles in 3 hours</li> <li>Ideal for moisture-sensitive stone</li> <li>Excellent sag resistance</li> <li>Coverage 40-80 sqft per bag, depending on size of trowel</li> </ul>	 <p><b>Unicare Natural Stone Matte Sealer</b></p> <ul style="list-style-type: none"> <li>For porous stones, natural stone only</li> <li>No change of colour</li> <li>No surface coating, sheen or shine at all</li> <li>Riven Sandstone &amp; Smooth Sandstone</li> <li>Coverage 6 m<sup>2</sup>/L depending on dilution</li> </ul>  <p><b>Unicare Natural Stone Colour Enhancer Sealer</b></p> <ul style="list-style-type: none"> <li>Colour enhancement for porous stones, natural stone only</li> <li>Breathable and easy to apply</li> <li>No surface coating, sheen or shine at all</li> <li>Riven Sandstone &amp; Smooth Sandstone</li> <li>Coverage 6 m<sup>2</sup>/L depending on dilution</li> </ul>
Colour	5-6mm Joints															
Beige, Stone Grey, Anthracite 55 lb bag / 1 kg can	125 sqft / 55 lb mix															
Colour	Narrow Joints	Wide Joints														
Beige, Grey, Ivory 50 lb bag	65-85 sqft	22-42 sqft														
Black 50 lb bag	58-76 sqft	20-38 sqft														

\*Please refer to Sands & Sealers on pages 190-202 for more detailed information.

Unsure of bonded vs. unbonded product recommendations? Please contact your Unilock Territory Manager for more information.

# PORCELAIN TILE SLABS



CERAMICHE  
**CAESAR**  
 LA CULTURA DELLA MATERIA



GOTHAM GREY *DELCONCA USA*



TRAVSTONE BEIGE *DELCONCA USA*



GRAUSTEIN *CAESAR*

## VISUAL APPEARANCE

Beautiful, premium Porcelain tile from Europe.

## FINISH

Smooth stone Finish, wood grain finish.

## PRODUCT SPECIFICATIONS



24 x 24 x 3/4"  
 600 x 600 x 20mm

## SOLAR REFLECTIVE INDEX (SRI) TESTING DETAILS

Product	Solar Reflectance	SRI
Travstone Beige	0.53	62 

\*Colour selection should be chosen from actual samples.

**TECHNICAL ADVANTAGES**

**PEDESTRIAN FRIENDLY**

Not recommended for vehicular loads

**PRODUCT DATA**

Stones & Bundling	Unit Thickness	SqFt Per			Boxes /Crate	Units Per		Lbs Per		
		Unit	Box	Crate		Box	Crate	Unit	Box	Crate
<b>Stocked in Ayr</b>										
Gotham 24" x 24" (600 x 600mm)	.79" (20mm)	3.88	7.75	255.75	33	2	66	36.1	-	2,382.6
Travestone 24" x 24" (600 x 600mm)	.79" (20mm)	3.88	7.75	255.75	33	2	66	36.1	-	2,382.6
Graustein 24" x 24" (600 x 600mm)	.79" (20mm)	3.88	7.75	232.80	30	2	60	36.3	72.60	2,178

Notes: Refer to metric measurements; all imperial measurements are nominal. Product is sold in full boxes only. For more information, samples or custom options, please contact your Unilock Territory Manager or call 1-800-UNILOCK.Territory Manager or call 1-800-UNILOCK.or call 1-800-UNILOCK for further information.\*For custom options, please contact your Unilock Territory Manager.

*\*All Natural Stone is being stocked at our Barrie location.*

**APPLICATIONS**



Pedestrian



Roof Deck



\*Contact your Unilock Territory Manager for installation best practices or visit [commercial.unilock.com](http://commercial.unilock.com) and refer to Porcelain Landscape Tile- Installation Guidelines.

[commercial.unilock.com/download/documents/technical-guides/](http://commercial.unilock.com/download/documents/technical-guides/)

RECOMMENDED SANDS		RECOMMENDED GROUTS															
 <p><b>Romex: Rompox<sup>®</sup> ECO-Fine</b>                      Pedestrian Applications only                      Vehicular when laid on a Trass Bed</p> <ul style="list-style-type: none"> <li>Ready mixed and easy to use</li> <li>Resin film free</li> <li>Resistant to ants, weeds, de-icing salts</li> <li>Made from 98% natural, recycled or renewable raw materials</li> <li>Pressure washer safe</li> <li>Ideal for joint widths from 5mm (1/4")</li> </ul> <p>Coverage:</p> <table border="1"> <thead> <tr> <th>Colour</th> <th>5-6mm Joints</th> </tr> </thead> <tbody> <tr> <td>Beige, Stone Grey, Anthracite</td> <td>125 sqft / 55 lb mix</td> </tr> <tr> <td>55 lb bag / 1 kg can</td> <td></td> </tr> </tbody> </table>		Colour	5-6mm Joints	Beige, Stone Grey, Anthracite	125 sqft / 55 lb mix	55 lb bag / 1 kg can		 <p><b>Alliance Gator Nitro Joint Sand</b>                      Pedestrian Applications only</p> <ul style="list-style-type: none"> <li>Ready mixed and easy to use</li> <li>Permeable</li> <li>Apply Rain or shine</li> <li>Hardens from top to bottom up to 2 3/8" (60mm)</li> <li>Must be installed above 37°F (3°C)</li> <li>Avoid power washing for 28 days after application</li> <li>Ideal for joint widths from 3mm (1/8")</li> </ul> <p>Coverage:</p> <table border="1"> <thead> <tr> <th>Colour</th> <th>3 mm Joints</th> </tr> </thead> <tbody> <tr> <td>Beige, Silver, 40 lb bag / 18.1 kg</td> <td>84 sqft / 40lb bag</td> </tr> <tr> <td>Black</td> <td>74 sqft</td> </tr> <tr> <td>Grey</td> <td>79 sqft</td> </tr> </tbody> </table>		Colour	3 mm Joints	Beige, Silver, 40 lb bag / 18.1 kg	84 sqft / 40lb bag	Black	74 sqft	Grey	79 sqft
Colour	5-6mm Joints																
Beige, Stone Grey, Anthracite	125 sqft / 55 lb mix																
55 lb bag / 1 kg can																	
Colour	3 mm Joints																
Beige, Silver, 40 lb bag / 18.1 kg	84 sqft / 40lb bag																
Black	74 sqft																
Grey	79 sqft																
		 <p><b>Ardex X32 Microtec (Thick bed mortar)</b></p> <ul style="list-style-type: none"> <li>Mix with water only- easy to mix &amp; apply</li> <li>Fast setting-grout tiles in 3 hours</li> <li>Ideal for moisture-sensitive stone</li> <li>Excellent sag resistance</li> <li>Coverage 40-80 sqft per bag, depending on size of trowel</li> </ul>															
		 <p><b>Ardex X90 Microtec (Thin bed mortar)</b></p> <ul style="list-style-type: none"> <li>Highest levels</li> <li>Fast setting-grout tiles in 3 hours</li> <li>Ideal for moisture-sensitive stone</li> <li>Excellent sag resistance</li> <li>Coverage 40-80 sqft per bag, depending on size of trowel</li> </ul>															

\*Please refer to Sands & Sealers on pages 190-202 for more detailed information.

Unsure of bonded vs. unbonded product recommendations? Please contact your Unilock Territory Manager for more information.

# PORCELAIN TILE SLABS

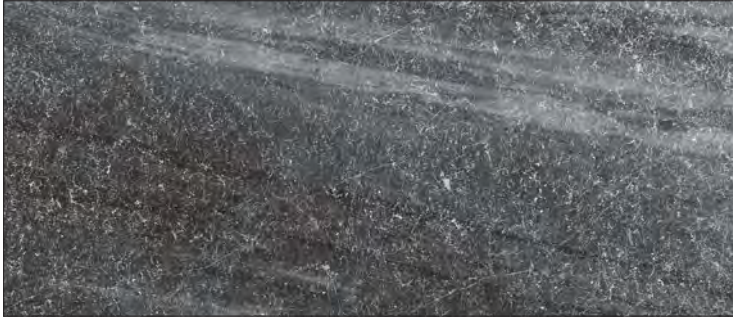

UNILOCK COSMIC GREY



UNILOCK DOVE GREY TRAVERTINE

---

## VISUAL APPEARANCE

Beautiful, premium Porcelain tile from Europe

## FINISH

Smooth stone finish

---

## PRODUCT SPECIFICATIONS



16 x 32 x 3/4"  
400 x 800 x 20mm

\*Colour selection should be chosen from actual samples.

**TECHNICAL ADVANTAGES**

**PEDESTRIAN FRIENDLY**

Not recommended for vehicular loads

**PRODUCT DATA**

Stones & Bundling	Unit Thickness	SqFt Per			Boxes /Crate	Units Per		Lbs Per		
		Unit	Box	Crate		Box	Crate	SqFt	Box	Crate
<b>Stocked in Ayr</b>										
Cosmic Grey 16" x 32" (400 x	.79 (20mm)	3.875	7.75	232.5	30	2	60	9.28	72.6	2,178
Dove Grey 16" x 32" (400 x 800mm)	.79 (20mm)	3.875	7.75	232.5	30	2	60	9.28	72.6	2,178

Notes: Refer to metric measurements; all imperial measurements are nominal. Product is sold in full boxes only. For more information, samples or custom options, please contact your Unilock Territory Manager or call 1-800-UNILOCK..

*\*All Natural Stone is being stocked at our Barrie location.*

**APPLICATIONS**



Pedestrian



Roof Deck



\*Contact your Unilock Territory Manager for installation best practices or visit [commercial.unilock.com](http://commercial.unilock.com) and refer to Porcelain Landscape Tile- Installation Guidelines.

[commercial.unilock.com/download/documents/technical-guides/](http://commercial.unilock.com/download/documents/technical-guides/)

RECOMMENDED SANDS		RECOMMENDED GROUTS															
 <p><b>Romex: Rompox® ECO-Fine</b> Pedestrian Applications only Vehicular when laid on a Trass Bed</p> <ul style="list-style-type: none"> <li>Ready mixed and easy to use</li> <li>Resin film free</li> <li>Resistant to ants, weeds, de-icing salts</li> <li>Made from 98% natural, recycled or renewable raw materials</li> <li>Pressure washer safe</li> <li>Ideal for joint widths from 5mm (1/4")</li> </ul> <p>Coverage:</p> <table border="1"> <thead> <tr> <th>Colour</th> <th>5-6mm Joints</th> </tr> </thead> <tbody> <tr> <td>Beige, Stone Grey, Anthracite</td> <td>125 sqft / 55 lb mix</td> </tr> <tr> <td></td> <td>55 lb bag / 1 kg can</td> </tr> </tbody> </table>		Colour	5-6mm Joints	Beige, Stone Grey, Anthracite	125 sqft / 55 lb mix		55 lb bag / 1 kg can	 <p><b>Alliance Gator Nitro Joint Sand</b> Pedestrian Applications only</p> <ul style="list-style-type: none"> <li>Ready mixed and easy to use</li> <li>Permeable</li> <li>Apply Rain or shine</li> <li>Hardens from top to bottom up to 2 3/8" (60mm)</li> <li>Must be installed above 37°F (3°C)</li> <li>Avoid power washing for 28 days after application</li> <li>Ideal for joint widths from 3mm (1/8")</li> </ul> <p>Coverage:</p> <table border="1"> <thead> <tr> <th>Colour</th> <th>3 mm Joints</th> </tr> </thead> <tbody> <tr> <td>Beige, Silver, Black, Grey</td> <td>84 sqft / 40lb bag</td> </tr> <tr> <td></td> <td>74 sqft</td> </tr> <tr> <td></td> <td>79 sqft</td> </tr> </tbody> </table>		Colour	3 mm Joints	Beige, Silver, Black, Grey	84 sqft / 40lb bag		74 sqft		79 sqft
Colour	5-6mm Joints																
Beige, Stone Grey, Anthracite	125 sqft / 55 lb mix																
	55 lb bag / 1 kg can																
Colour	3 mm Joints																
Beige, Silver, Black, Grey	84 sqft / 40lb bag																
	74 sqft																
	79 sqft																
		 <p><b>Ardex X32 Microtec (Thick bed mortar)</b></p> <ul style="list-style-type: none"> <li>Mix with water only- easy to mix &amp; apply</li> <li>Fast setting-grout tiles in 3 hours</li> <li>Ideal for moisture-sensitive stone</li> <li>Excellent sag resistance</li> <li>Coverage 40-80 sqft per bag, depending on size of trowel</li> </ul>															
		 <p><b>Ardex X90 Microtec (Thin bed mortar)</b></p> <ul style="list-style-type: none"> <li>Highest levels</li> <li>Fast setting-grout tiles in 3 hours</li> <li>Ideal for moisture-sensitive stone</li> <li>Excellent sag resistance</li> <li>Coverage 40-80 sqft per bag, depending on size of trowel</li> </ul>															

\*Please refer to Sands & Sealers on pages 190-202 for more detailed information.

Unsure of bonded vs. unbonded product recommendations? Please contact your Unilock Territory Manager for more information.

# PORCELAIN TILE SLABS



*\*Special Order only. Minimum qty's apply\**

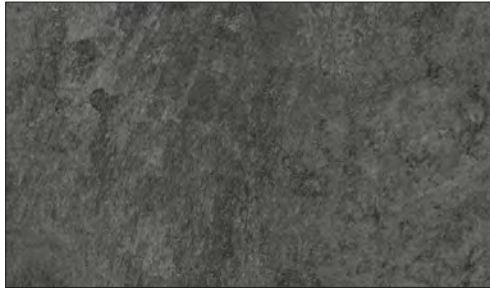

ANTRACITE



BEIGE



BIANCO



GRIGIO

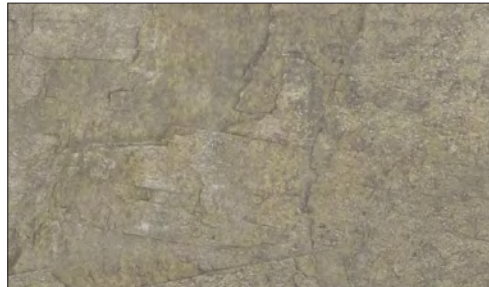

NATURALE

## VISUAL APPEARANCE

Beautiful, premium Porcelain tile from Europe

## FINISH

Smooth stone finish

## PRODUCT SPECIFICATIONS



48 x 48 x  $\frac{3}{4}$ "  
120 x 120 x 20mm



24 x 36 x  $\frac{3}{4}$ "  
600 x 900 x 20mm



24 x 24 x  $\frac{3}{4}$ "  
600 x 600 x 20mm

## SOLAR REFLECTIVE INDEX (SRI) TESTING DETAILS

Product	SRI
Beige	51
Bianco	73

## FEATURES & BENEFITS

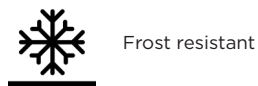
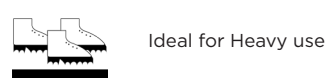
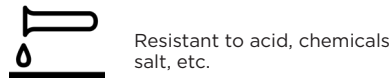
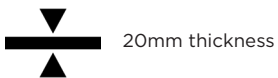

\*Colour selection should be chosen from actual samples.

**TECHNICAL ADVANTAGES**

**PEDESTRIAN FRIENDLY**

Not recommended for vehicular loads

**PRODUCT DATA**

Stones & Bundling	Unit Thickness	SqFt Per			Boxes /Crate	Units Per		Lbs Per		
		Unit	Box	Crate		Box	Crate	SqFt	Box	Crate
<b>Stocked in Ayr</b>										
48 x 48 x 3/4" 120 x 120 x 20mm	.79" (20mm)	15.50	15.50	279	18	1	18	9.72	150.6	2,756
24 x 36 x 3/4" 600 x 900 x 20mm	.79" (20mm)	5.81	5.81	290.50	50	1	50	9.10	52.91	2,690
24 x 24 x 3/4" 600 x 600 x 20mm	.79 (20mm)	7.75	15.50	256	32	2	64	4.55	70.55	2,315

Notes: Refer to metric measurements; all imperial measurements are nominal. Product is sold in full boxes only. For more information, samples or custom options, please contact your Unilock Territory Manager or call 1-800-UNILOCK.

**APPLICATIONS**



Pedestrian



Roof Deck



\*Contact your Unilock Territory Manager for installation best practices or visit [commercial.unilock.com](http://commercial.unilock.com) and refer to Porcelain Landscape Tile- Installation Guidelines.

[commercial.unilock.com/download/documents/technical-guides/](http://commercial.unilock.com/download/documents/technical-guides/)

RECOMMENDED SANDS		RECOMMENDED GROUTS													
 <p><b>Romex: Rompox<sup>®</sup> ECO-Fine</b> Pedestrian Applications only Vehicular when laid on a Trass Bed</p> <ul style="list-style-type: none"> <li>Ready mixed and easy to use</li> <li>Resin film free</li> <li>Resistant to ants, weeds, de-icing salts</li> <li>Made from 98% natural, recycled or renewable raw materials</li> <li>Pressure washer safe</li> <li>Ideal for joint widths from 5mm (1/4")</li> </ul> <p><b>Coverage:</b></p> <table border="1"> <thead> <tr> <th>Colour</th> <th>5-6mm Joints</th> </tr> </thead> <tbody> <tr> <td>Beige, Stone Grey, Anthracite 55 lb bag / 1 kg can</td> <td>125 sqft / 55 lb mix</td> </tr> </tbody> </table>	Colour	5-6mm Joints	Beige, Stone Grey, Anthracite 55 lb bag / 1 kg can	125 sqft / 55 lb mix	 <p><b>Alliance Gator Nitro Joint Sand</b> Pedestrian Applications only</p> <ul style="list-style-type: none"> <li>Ready mixed and easy to use</li> <li>Permeable</li> <li>Apply Rain or shine</li> <li>Hardens from top to bottom up to 2 3/8" (60mm)</li> <li>Must be installed above 37°F (3°C)</li> <li>Avoid power washing for 28 days after application</li> <li>Ideal for joint widths from 3mm (1/8")</li> </ul> <p><b>Coverage:</b></p> <table border="1"> <thead> <tr> <th>Colour</th> <th>3 mm Joints</th> </tr> </thead> <tbody> <tr> <td>Beige, Silver, 40 lb bag / 18.1 kg</td> <td>84 sqft / 40lb bag</td> </tr> <tr> <td>Black</td> <td>74 sqft</td> </tr> <tr> <td>Grey</td> <td>79 sqft</td> </tr> </tbody> </table>	Colour	3 mm Joints	Beige, Silver, 40 lb bag / 18.1 kg	84 sqft / 40lb bag	Black	74 sqft	Grey	79 sqft	 <p><b>ArDEX X32 Microtec</b> (Thick bed mortar)</p> <ul style="list-style-type: none"> <li>Mix with water only- easy to mix &amp; apply</li> <li>Fast setting-grout tiles in 3 hours</li> <li>Ideal for moisture-sensitive stone</li> <li>Excellent sag resistance</li> <li>Coverage 40-80 sqft per bag, depending on size of trowel</li> </ul>	 <p><b>ArDEX X90 Microtec</b> (Thin bed mortar)</p> <ul style="list-style-type: none"> <li>Highest levels</li> <li>Fast setting-grout tiles in 3 hours</li> <li>Ideal for moisture-sensitive stone</li> <li>Excellent sag resistance</li> <li>Coverage 40-80 sqft per bag, depending on size of trowel</li> </ul>
Colour	5-6mm Joints														
Beige, Stone Grey, Anthracite 55 lb bag / 1 kg can	125 sqft / 55 lb mix														
Colour	3 mm Joints														
Beige, Silver, 40 lb bag / 18.1 kg	84 sqft / 40lb bag														
Black	74 sqft														
Grey	79 sqft														

\*Please refer to Sands & Sealers on pages 190-202 for more detailed information.

Unsured of bonded vs. unbonded product recommendations? Please contact your Unilock Territory Manager for more information.

# GRANITE

## BLACK OYSTER

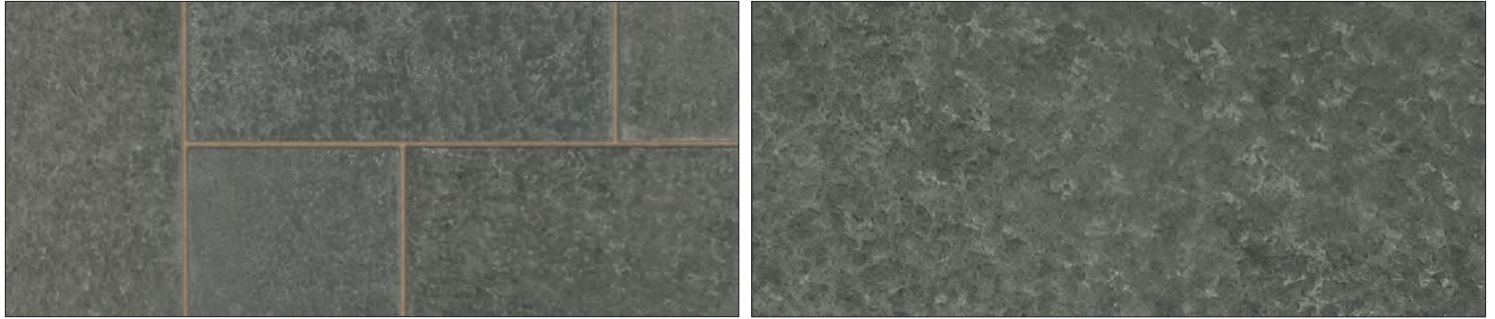

Stone Type	Coarse Grained Granite
Visual Appearance	Charcoal Grey to black with white and black crystals
Origin	Fujian, China
Generic Stone Name	G684 Fuding Black
Age	Jurassic Period (170 million years)
Finish	Sawn 6 sides & Flamed

### PRODUCT SPECIFICATIONS



12 x 24 x 1 or 2"  
300 x 600 x 25 or 50mm



12 x 36 x 2"  
300 x 900 x 50mm



24 x 24 x 1 or 2"  
600 x 600 x 25 or 50mm

### LEED TESTING DETAILS

Testing Details	Mean
Water Absorbancy	0.07%
Apparent Density	2973 kg/m <sup>3</sup>
Flextural Strength	18.8 MPa
Abrasion resistance	14.5 mm
Slip Resistance (When Wet)	66

### SOLAR REFLECTIVE INDEX (SRI) TESTING DETAILS

Product	Solar Reflectance	Solar Absorptance	Thermal Emittance
Black Oyster	0.13	0.87	0.89

\*Colour selection should be chosen from actual samples.



**TECHNICAL ADVANTAGES**

**PEDESTRIAN FRIENDLY**

Not recommended for vehicular loads

**PRODUCT DATA**

**Granite Slab - 25mm**

Stones & Bundling	Unit Thickness	SqFt/ Crate	SqFt/ Stone	Units/ SqFt	Units/ Crates	Lbs/ Unit	Lbs/ Crate
12" x 24" (300 x 600mm)	1" (25mm)	200	2	0.5	100	27	2,700
24" x 24" (600 x 600mm)	1" (25mm)	200	4	0.25	50	54.60	2,730

For more information, samples or custom options, please contact your Unilock Territory Manager or call 1-800-UNILOCK.

*\*All Natural Stone is being stocked at our Barrie location.*

**Granite Slab - 50mm**

Stones & Bundling	Unit Thickness	SqFt/ Crate	SqFt/ Stone	Units/ SqFt	Units/ Crates	Lbs/ Unit	Lbs/ Crate
12" x 24" (300 x 600mm)	2" (50mm)	80	2	0.50	40	58	2,336
24" x 24" (600 x 600mm)	2" (50mm)	80	4	0.25	20	110	2,204
12" x 36" (300 x 900mm)	2" (50mm)	78	3.25	0.31	24	97.37	2,337

For more information, samples or custom options, please contact your Unilock Territory Manager or call 1-800-UNILOCK.

*\*All Natural Stone is being stocked at our Barrie location.*

**APPLICATIONS**



Pedestrian









Roof Deck



\*Contact your Unilock Territory Manager for installation best practices or visit [commercial.unilock.com](http://commercial.unilock.com) and refer to Natural Stone- Installation Guidelines.

[commercial.unilock.com/download/documents/technical-guides/](http://commercial.unilock.com/download/documents/technical-guides/)

RECOMMENDED SANDS		RECOMMENDED GROUTS		RECOMMENDED SEALERS											
 <p><b>Romex: Rompox<sup>®</sup> ECO-Fine</b> Pedestrian Applications only Vehicular when laid on a Trass Bed</p> <ul style="list-style-type: none"> <li>Ready mixed and easy to use</li> <li>Resin film free</li> <li>Resistant to ants, weeds, de-icing salts</li> <li>Made from 98% natural, recycled or renewable raw materials</li> <li>Pressure washer safe</li> <li>Ideal for joint widths from 5mm (1/4")</li> </ul> <p>Coverage:</p> <table border="1"> <thead> <tr> <th>Colour</th> <th>5-6mm Joints</th> </tr> </thead> <tbody> <tr> <td>Beige, Stone Grey, Anthracite 55 lb bag / 1 kg can</td> <td>125 sqft / 55 lb mix</td> </tr> </tbody> </table>	Colour	5-6mm Joints	Beige, Stone Grey, Anthracite 55 lb bag / 1 kg can	125 sqft / 55 lb mix	 <p><b>Alliance Gator Nitro Joint Sand</b> Pedestrian Applications only</p> <ul style="list-style-type: none"> <li>Ready mixed and easy to use</li> <li>Permeable</li> <li>Apply Rain or shine</li> <li>Hardens from top to bottom up to 2 3/8" (60mm)</li> <li>Must be installed above 37°F (3°C)</li> <li>Avoid power washing for 28 days after application</li> <li>Ideal for joint widths from 3mm (1/8")</li> </ul> <p>Coverage:</p> <table border="1"> <thead> <tr> <th>Colour</th> <th>3 mm Joints</th> </tr> </thead> <tbody> <tr> <td>Beige, Silver, 40 lb bag / 18.1 kg</td> <td>84 sqft / 40lb bag</td> </tr> <tr> <td>Black</td> <td>74 sqft</td> </tr> <tr> <td>Grey</td> <td>79 sqft</td> </tr> </tbody> </table>	Colour	3 mm Joints	Beige, Silver, 40 lb bag / 18.1 kg	84 sqft / 40lb bag	Black	74 sqft	Grey	79 sqft	 <p><b>Ardez X32 Microtec</b> (Thick bed mortar)</p> <ul style="list-style-type: none"> <li>Mix with water only- easy to mix &amp; apply</li> <li>Fast setting-grout tiles in 3 hours</li> <li>Ideal for moisture-sensitive stone</li> <li>Excellent sag resistance</li> <li>Coverage 40-80 sqft per bag, depending on size of trowel</li> </ul>  <p><b>Ardez X90 Microtec</b> (Thin bed mortar)</p> <ul style="list-style-type: none"> <li>Highest levels</li> <li>Fast setting-grout tiles in 3 hours</li> <li>Ideal for moisture-sensitive stone</li> <li>Excellent sag resistance</li> <li>Coverage 40-80 sqft per bag, depending on size of trowel</li> </ul>	 <p><b>Unicare Natural Stone Matte Sealer</b></p> <ul style="list-style-type: none"> <li>For porous stones, natural stone only</li> <li>No change of colour</li> <li>No surface coating, sheen or shine at all</li> <li>Riven Sandstone &amp; Smooth Sandstone</li> <li>Coverage 6 m<sup>2</sup>/L depending on dilution</li> </ul>  <p><b>Unicare Natural Stone Colour Enhancer Sealer</b></p> <ul style="list-style-type: none"> <li>Colour enhancement for porous stones, natural stone only</li> <li>Breathable and easy to apply</li> <li>No surface coating, sheen or shine at all</li> <li>Riven Sandstone &amp; Smooth Sandstone</li> <li>Coverage 6 m<sup>2</sup>/L depending on dilution</li> </ul>
Colour	5-6mm Joints														
Beige, Stone Grey, Anthracite 55 lb bag / 1 kg can	125 sqft / 55 lb mix														
Colour	3 mm Joints														
Beige, Silver, 40 lb bag / 18.1 kg	84 sqft / 40lb bag														
Black	74 sqft														
Grey	79 sqft														

\*Please refer to Sands & Sealers on pages 190-202 for more detailed information.

Unsure of bonded vs. unbonded product recommendations? Please contact your Unilock Territory Manager for more information.

# GRANITE

## CASTLE GREY



Stone Type	Coarse Grained Granite
Visual Appearance	Mid Grey with white and black crystals
Origin	Fujian, China
Generic Stone Name	G654
Age	Jurassic Period (170 million years)
Finish	Sawn 6 sides & Flamed

### PRODUCT SPECIFICATIONS



12 x 24 x 1 or 2"  
300 x 600 x 25 or 50mm



12 x 36 x 2"  
300 x 900 x 50mm



24 x 24 x 1 or 2"  
600 x 600 x 25 or 50mm

### LEED TESTING DETAILS

Testing Details	Mean
Water Absorbancy	0.30%
Apparent Density	2779 kg/m <sup>3</sup>
Flexural Strength	14.4 MPa
Abrasion resistance	13 mm
Slip Resistance (When Wet)	76

### SOLAR AND THERMAL OPTICAL PROPERTIES

Product	Solar Reflectance	Solar Absorptance	Thermal Emittance
Castle Grey	0.25	0.75	0.90

\*Colour selection should be chosen from actual samples.

**TECHNICAL ADVANTAGES**

**PEDESTRIAN FRIENDLY**

Not recommended for vehicular loads

**PRODUCT DATA**

**Granite Slab - 25mm**

Stones & Bundling	Unit Thickness	SqFt/ Crate	SqFt/ Stone	Units/ SqFt	Units/ Crates	Lbs/ Unit	Lbs/ Crate
12" x 24" (300 x 600mm)	1" (25mm)	200	2	0.50	100	27	2,700
24" x 24" (600 x 600mm)	1" (25mm)	200	4	0.25	50	54.60	2,730

For more information, samples or custom options, please contact your Unilock Territory Manager or call 1-800-UNILOCK.

*\*All Natural Stone is being stocked at our Barrie location.*

**Granite Slab - 50mm**

Stones & Bundling	Unit Thickness	SqFt/ Crate	SqFt/ Stone	Units/ SqFt	Units/ Crates	Lbs/ Unit	Lbs/ Crate
12" x 24" (300 x 600mm)	2" (50mm)	80	2	0.50	40	58	2,336
24" x 24" (600 x 600mm)	2" (50mm)	80	4	0.25	20	110	2,204
12" x 36" (300 x 900mm)	2" (50mm)	78	3.25	0.31	24	97.37	2,337

For more information, samples or custom options, please contact your Unilock Territory Manager or call 1-800-UNILOCK.

*\*All Natural Stone is being stocked at our Barrie location.*

**APPLICATIONS**



Pedestrian





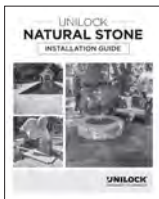



Roof Deck



\*Contact your Unilock Territory Manager for installation best practices or visit [commercial.unilock.com](http://commercial.unilock.com) and refer to Natural Stone- Installation Guidelines.

[commercial.unilock.com/download/documents/technical-guides/](http://commercial.unilock.com/download/documents/technical-guides/)

RECOMMENDED SANDS		RECOMMENDED GROUTS		RECOMMENDED SEALERS							
 <p><b>Romox: Rompox<sup>®</sup> ECO-Fine</b> Pedestrian Applications only Vehicular when laid on a Trass Bed</p> <ul style="list-style-type: none"> <li>Ready mixed and easy to use</li> <li>Resin film free</li> <li>Resistant to ants, weeds, de-icing salts</li> <li>Made from 98% natural, recycled or renewable raw materials</li> <li>Pressure washer safe</li> <li>Ideal for joint widths from 5mm (1/4")</li> </ul> <p>Coverage:</p> <table border="1"> <tr> <th>Colour</th> <th>5-6mm Joints</th> </tr> <tr> <td>Beige, Stone Grey, Anthracite 55 lb bag / 1 kg can</td> <td>125 sqft / 55 lb mix</td> </tr> </table>	Colour	5-6mm Joints	Beige, Stone Grey, Anthracite 55 lb bag / 1 kg can	125 sqft / 55 lb mix	 <p><b>Alliance Gator Nitro Joint Sand</b> Pedestrian Applications only</p> <ul style="list-style-type: none"> <li>Ready mixed and easy to use</li> <li>Permeable</li> <li>Apply Rain or shine</li> <li>Hardens from top to bottom up to 2 3/4" (60mm)</li> <li>Must be installed above 37°F (3°C)</li> <li>Avoid power washing for 28 days after application</li> <li>Ideal for joint widths from 3mm (1/8")</li> </ul> <p>Coverage:</p> <table border="1"> <tr> <th>Colour</th> <th>3 mm Joints</th> </tr> <tr> <td>Beige, Silver, 40 lb bag / 18.1 kg Black Grey</td> <td>84 sqft / 40lb bag 74 sqft 79 sqft</td> </tr> </table>	Colour	3 mm Joints	Beige, Silver, 40 lb bag / 18.1 kg Black Grey	84 sqft / 40lb bag 74 sqft 79 sqft	 <p><b>Ardex X32 Microtec (Thick bed mortar)</b></p> <ul style="list-style-type: none"> <li>Mix with water only- easy to mix &amp; apply</li> <li>Fast setting-grout tiles in 3 hours</li> <li>Ideal for moisture-sensitive stone</li> <li>Excellent sag resistance</li> <li>Coverage 40-80 sqft per bag, depending on size of trowel</li> </ul>  <p><b>Ardex X90 Microtec (Thin bed mortar)</b></p> <ul style="list-style-type: none"> <li>Highest levels</li> <li>Fast setting-grout tiles in 3 hours</li> <li>Ideal for moisture-sensitive stone</li> <li>Excellent sag resistance</li> <li>Coverage 40-80 sqft per bag, depending on size of trowel</li> </ul>	 <p><b>Unicare Natural Stone Matte Sealer</b></p> <ul style="list-style-type: none"> <li>For porous stones, natural stone only</li> <li>No change of colour</li> <li>No surface coating, sheen or shine at all</li> <li>Riven Sandstone &amp; Smooth Sandstone</li> <li>Coverage 6 m<sup>2</sup>/L depending on dilution</li> </ul>  <p><b>Unicare Natural Stone Colour Enhancer Sealer</b></p> <ul style="list-style-type: none"> <li>Colour enhancement for porous stones, natural stone only</li> <li>Breathable and easy to apply</li> <li>No surface coating, sheen or shine at all</li> <li>Riven Sandstone &amp; Smooth Sandstone</li> <li>Coverage 6 m<sup>2</sup>/L depending on dilution</li> </ul>
Colour	5-6mm Joints										
Beige, Stone Grey, Anthracite 55 lb bag / 1 kg can	125 sqft / 55 lb mix										
Colour	3 mm Joints										
Beige, Silver, 40 lb bag / 18.1 kg Black Grey	84 sqft / 40lb bag 74 sqft 79 sqft										

\*Please refer to Sands & Sealers on pages 190-202 for more detailed information.

Unsure of bonded vs. unbonded product recommendations? Please contact your Unilock Territory Manager for more information.

# GRANITE

## GALAXY FROST



Stone Type	Coarse Grained Granite
Visual Appearance	Pale grey to off-white with white and black crystals
Origin	Fujian, China
Generic Stone Name	G603-4
Age	Jurassic Period (170 million years)
Finish	Sawn 6 sides & Flamed

### PRODUCT SPECIFICATIONS



12 x 24 x 1 or 2"  
300 x 600 x 25 or 50mm



12 x 36 x 2"  
300 x 900 x 50mm



24 x 24 x 1 or 2"  
600 x 600 x 25 or 50mm

### LEED TESTING DETAILS

Testing Details	Mean
Water Absorbancy	0.30%
Apparent Density	2634 kg/m <sup>3</sup>
Flexural Strength	14.4 MPa
Abrasion resistance	15 mm
Slip Resistance (When Wet)	68

### SOLAR AND THERMAL OPTICAL PROPERTIES

Product	Solar Reflectance	Solar Absorptance	Thermal Emittance
Galaxy Frost	0.53	0.47	0.90

### SOLAR REFLECTIVE INDEX (SRI) TESTING DETAILS

Product	Solar Reflectance	SRI
Galaxy Frost	0.53	62 

\*Colour selection should be chosen from actual samples.

**TECHNICAL ADVANTAGES**

**PEDESTRIAN FRIENDLY**

Not recommended for vehicular loads

**PRODUCT DATA**

**Granite Slab - 25mm**

Stones & Bundling	Unit Thickness	SqFt/ Crate	SqFt/ Stone	Units/ SqFt	Units/ Crates	Lbs/ Unit	Lbs/ Crate
12" x 24" (300 x 600mm)	1" (25mm)	200	2	0.50	100	27	2,700
24" x 24" (600 x 600mm)	1" (25mm)	200	4	0.25	50	54.60	2,730

For more information, samples or custom options, please contact your Unilock Territory Manager or call 1-800-UNILOCK.

*\*All Natural Stone is being stocked at our Barrie location.*

**Granite Slab - 50mm**

Stones & Bundling	Unit Thickness	SqFt/ Crate	SqFt/ Stone	Units/ SqFt	Units/ Crates	Lbs/ Unit	Lbs/ Crate
12" x 24" (300 x 600mm)	2" (50mm)	80	2	0.50	40	58	2,336
24" x 24" (600 x 600mm)	2" (50mm)	80	4	0.25	20	110	2,204
12" x 36" (300 x 900mm)	2" (50mm)	78	3.25	0.31	24	97.37	2,337

For more information, samples or custom options, please contact your Unilock Territory Manager or call 1-800-UNILOCK.

*\*All Natural Stone is being stocked at our Barrie location.*







**APPLICATIONS**



Pedestrian



Roof Deck

RECOMMENDED SANDS		RECOMMENDED GROUTS		RECOMMENDED SEALERS													
 <p><b>Romex: Rompox<sup>®</sup> ECO-Fine</b>  <i>Pedestrian Applications only</i>  <b>Vehicular when laid on a Trass Bed</b></p> <ul style="list-style-type: none"> <li>Ready mixed and easy to use</li> <li>Resin film free</li> <li>Resistant to ants, weeds, de-icing salts</li> <li>Made from 98% natural, recycled or renewable raw materials</li> <li>Pressure washer safe</li> <li>Ideal for joint widths from 5mm (1/4")</li> </ul> <p>Coverage:</p> <table border="1"> <thead> <tr> <th>Colour</th> <th>5-6mm Joints</th> </tr> </thead> <tbody> <tr> <td>Beige, Stone Grey, Anthracite</td> <td>125 sqft / 55 lb mix</td> </tr> <tr> <td></td> <td>55 lb bag / 1 kg can</td> </tr> </tbody> </table>	Colour	5-6mm Joints	Beige, Stone Grey, Anthracite	125 sqft / 55 lb mix		55 lb bag / 1 kg can	 <p><b>Alliance Gator Nitro Joint Sand</b>  <i>Pedestrian Applications only</i></p> <ul style="list-style-type: none"> <li>Ready mixed and easy to use</li> <li>Permeable</li> <li>Apply Rain or shine</li> <li>Hardens from top to bottom up to 2 3/8" (60mm)</li> <li>Must be installed above 37°F (3°C)</li> <li>Avoid power washing for 28 days after application</li> <li>Ideal for joint widths from 3mm (1/8")</li> </ul> <p>Coverage:</p> <table border="1"> <thead> <tr> <th>Colour</th> <th>3 mm Joints</th> </tr> </thead> <tbody> <tr> <td>Beige, Silver, 40 lb bag / 18.1 kg</td> <td>84 sqft / 40lb bag</td> </tr> <tr> <td>Black</td> <td>74 sqft</td> </tr> <tr> <td>Grey</td> <td>79 sqft</td> </tr> </tbody> </table>	Colour	3 mm Joints	Beige, Silver, 40 lb bag / 18.1 kg	84 sqft / 40lb bag	Black	74 sqft	Grey	79 sqft	 <p><b>Ardex X32 Microtec</b> (<i>Thick bed mortar</i>)</p> <ul style="list-style-type: none"> <li>Mix with water only- easy to mix &amp; apply</li> <li>Fast setting-grout tiles in 3 hours</li> <li>Ideal for moisture-sensitive stone</li> <li>Excellent sag resistance</li> <li>Coverage 40-80 sqft per bag, depending on size of trowel</li> </ul>  <p><b>Ardex X90 Microtec</b> (<i>Thin bed mortar</i>)</p> <ul style="list-style-type: none"> <li>Highest levels</li> <li>Fast setting-grout tiles in 3 hours</li> <li>Ideal for moisture-sensitive stone</li> <li>Excellent sag resistance</li> <li>Coverage 40-80 sqft per bag, depending on size of trowel</li> </ul>	 <p><b>Unicare Natural Stone Matte Sealer</b></p> <ul style="list-style-type: none"> <li>For porous stones, natural stone only</li> <li>No change of colour</li> <li>No surface coating, sheen or shine at all</li> <li>Riven Sandstone &amp; Smooth Sandstone</li> <li>Coverage 6 m<sup>2</sup>/L depending on dilution</li> </ul>  <p><b>Unicare Natural Stone Colour Enhancer Sealer</b></p> <ul style="list-style-type: none"> <li>Colour enhancement for porous stones, natural stone only</li> <li>Breathable and easy to apply</li> <li>No surface coating, sheen or shine at all</li> <li>Riven Sandstone &amp; Smooth Sandstone</li> <li>Coverage 6 m<sup>2</sup>/L depending on dilution</li> </ul>
Colour	5-6mm Joints																
Beige, Stone Grey, Anthracite	125 sqft / 55 lb mix																
	55 lb bag / 1 kg can																
Colour	3 mm Joints																
Beige, Silver, 40 lb bag / 18.1 kg	84 sqft / 40lb bag																
Black	74 sqft																
Grey	79 sqft																

*\*Please refer to Sands & Sealers on pages 190-202 for more detailed information.*

*Unsure of bonded vs. unbonded product recommendations? Please contact your Unilock Territory Manager for more information.*





UNILOCK® COLLECTION OF

# Retaining Walls & Vertical Features

Unlimited creative possibilities exist for retaining soil or building vertical features like grill islands and firepits. Now the durability of EnduraColor™ is available, thanks to our U-Cara® Multi-Face Wall System.

**Pavers:** Artline™ (Granite Fusion) with Mattoni™ (Dark Charcoal) accent

**Walls:** U-Cara® (Opal Blend Smooth) with Universal Coping (Light Grey)

# BRUSSELS DIMENSIONAL STONE<sup>®</sup>

## CLASSIC



COFFEE CREEK



LIMESTONE



MAHOGANY



MIDNIGHT CHARCOAL



SANDSTONE

### VISUAL APPEARANCE

The antiqued appearance of Brussels Dimensional Stone is great for gardens and seat walls.

### FINISH

Weathered, antiqued, tumbled.

### PRODUCT SPECIFICATIONS



**STANDARD**  
8 x 12 x 4"  
200 x 300 x 100mm

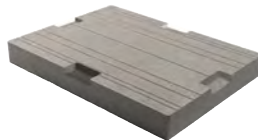

**U-GRIP™ BASE PAD**  
14 x 19 x 2"  
355 x 482 x 55mm

### GRAVITY WALL SECTION

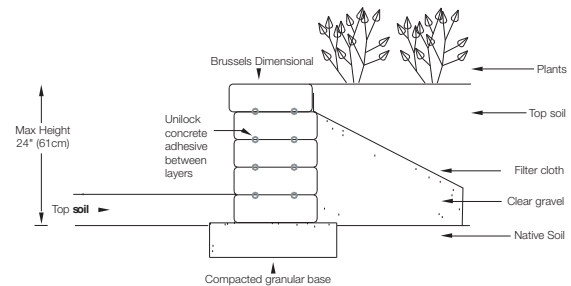

Cross sections are examples and must not be used for construction.



- Creates a revolutionary Reinforced Soil Structure (RSS) with high tensile and compressive strength to maximize the performance of pavement structures.
- Extremely permeable, long lasting, durable and environmentally friendly. Lightweight and easy to handle.
- Simple and quick installation.
- Allows for easy repairs / adjustments after installation.

See page 186-187 for more details.

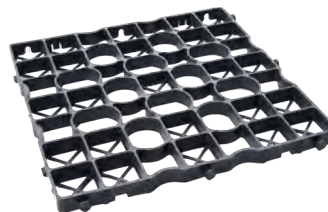

**DRIVECEL30 LIGHT DUTY**  
20 x 20 x 1.2"  
500 x 500 x 30mm

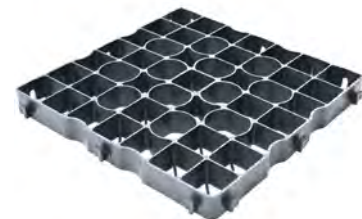

**DRIVECEL50 HEAVY DUTY**  
20 x 20 x 2"  
500 x 500 x 50mm

\*Colour selection should be chosen from actual samples.



# SUNSET FIREPIT KITS

AVAILABLE COLOURS: Coffee Creek, Mahogany Ash and Sandstone

See page 174 for more details

Round



Square



## TECHNICAL INFORMATION

### ASTM C 936 Standard Specifications for Solid Concrete Interlocking

Conforms to:

- C140 for Absorption 5% avg - 7% max
- Compressive Strength > 3,000 PSI
- C1262 for Freeze Thaw Durability < 1% mass loss
- C1372 Overall dimensional variations permissible for width, height and length +/- 3mm

### Unilock standards exceed 6,000 PSI for Brussels Dimensional Stone® products with:

- 4% absorption avg.
  - 5% absorption max.
  - Dimensional Accuracy +/- 5/64" (+/-2.00mm)
- Test results available upon request

### Meets the U.S. Architectural & Transportation Barrier Compliance Board Slip-Resistance Surfaces Advisory

## LEED INFORMATION

### Materials & Resources: LEED V4:

- Building Product Disclosure and Optimization
- Sourcing of Raw Materials - Sourcing of Raw Materials and Extraction • 1 point
- Sourcing of Raw Materials - Leadership Extraction Practices • 1 point
- Material Ingredient Reporting - Material Ingredient Reporting • 1 point
- Material Ingredient Reporting - Material Ingredient Optimization • 1 point
- Environmental Product Declaration • 1 point

## PRODUCT DATA

Stones & Bundling	Face Feet Per			Linear Feet Per		Units Per		Per Bundle		Lbs Per	
	Bundle	Layer	Unit	Bundle	Unit	Bundle	Face Feet	Layers	Sections	Unit	Bundle
<b>Ayr Manufacturing</b>											
Standard	32.00	5.33	0.33	96.00	1.00	96	-	6	4	30	2,881
U-GRIP Base Pad Gormley Manufacturing	-	-	-	85.39	1.58	54	-	9	-	46	2,500

Notes: Product is installed using Unilock Concrete Adhesive to secure corners and all rows. Maximum height is 24" including the unit in the ground (under optimum conditions). All measurements are nominal. \*Based on 12" deep wall coverage = 21.4 sqft per bundle. Based on an 8" deep wall coverage = 32 sqft per bundle. For more information, samples or custom options, please contact your Unilock Territory Manager or call 1-800-UNILOCK.

## APPLICATIONS



Garden Walls & Seat Walls



Fire Features



Water Features



Grill Islands



Pillars

Coping Options - We recommend using Ledgestone™, Natural Stone, Universal Coping, Brussels Fullnose™ or Umbriano® Coping.

### RECOMMENDED ADHESIVE



**Alliance Gator Block Bond XP**

- | VOC Compliant
- | Low odour- safe indoors or out
- | Fast curing- provides permanent overnight bond
- | Suitable for use in hot and cold environments
- | Non-shrinking- does not crack
- | Strong and versatile

**Coverage: For 1/4" Bead (approx)**

10 oz		28 oz	
m	ft.	m	ft.
-9	-31	-26	-86

## FRONT ELEVATION

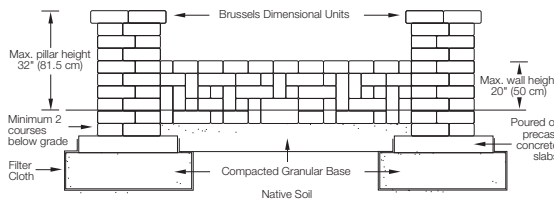

All joints must be adhered with Unilock approved Concrete Adhesive. Base preparation may vary according to soil and climate conditions. Cross sections are examples, and must not be used for construction.

WALLS | BRUSSELS DIMENSIONAL STONE®

RETAINING WALLS & VERTICAL FEATURES

# DURAHOLD®

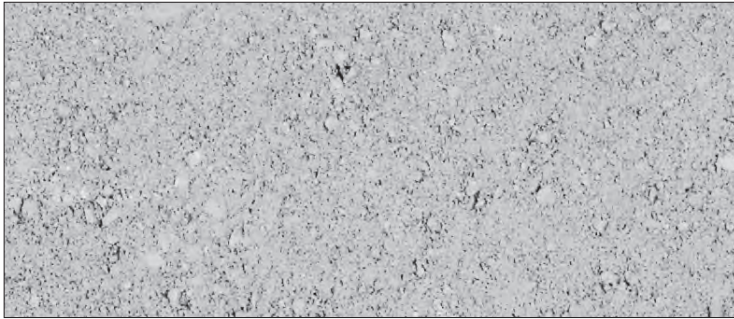

NATURAL











## VISUAL APPEARANCE

DuraHold® and DuraHold2® are similar in appearance. DuraHold is nearly twice the depth of DuraHold 2. This product gives an industrial appearance.

## FINISH

Standard.

## PRODUCT SPECIFICATIONS

			
<b>STANDARD</b> 24 x 72 x 12" 600 x 1830 x 300mm	<b>COPING</b> 24 x 72 x 12" 600 x 1830 x 300mm	<b>CLOSED-END COPING</b> 24 x 72 x 12" 600 x 1830 x 300mm	<b>TIE-BACK</b> 24 x 72 x 12" 600 x 1830 x 300mm
			
<b>1/2 STANDARD</b> 24 x 36 x 12" 600 x 95 x 300mm	<b>1/2 COPING</b> 24 x 36 x 12" 600 x 95 x 300mm	<b>CORNER 90°</b> 24 x 60 x 12" 600 x 1524 x 300mm <i>(Right Corner shown)</i>	<b>CORNER 45°</b> 24 x 60 x 12" 600 x 1524 x 300mm <i>(Right Corner shown)</i>



See page 186-187 for more details.

## CROSS SECTIONS

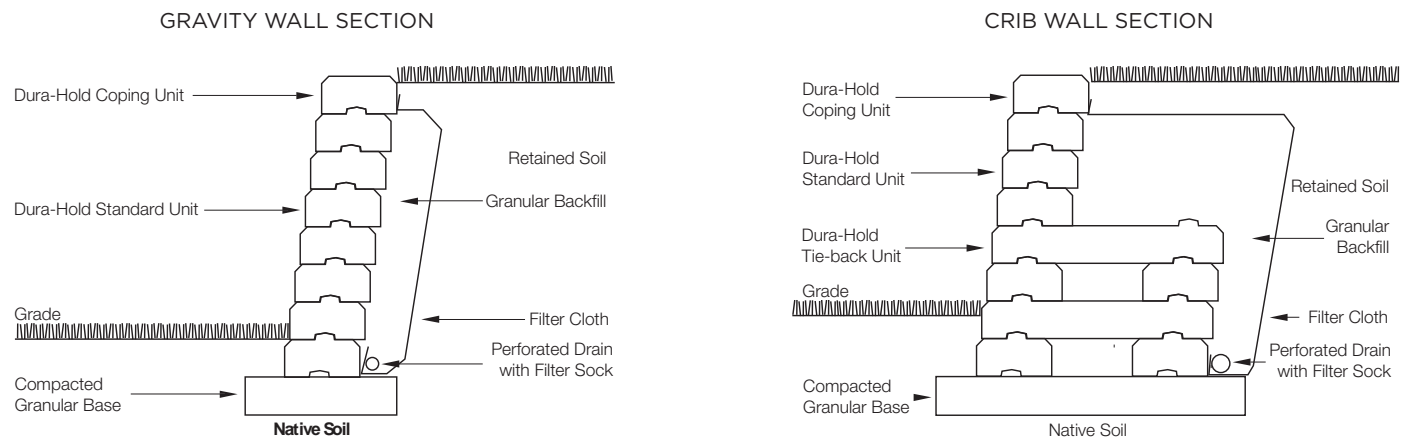

\*Colour selection should be chosen from actual samples.

Cross sections are examples, and must not be used for construction.

**TECHNICAL INFORMATION**

**ASTM C 1372 Standard Specifications for Dry-Cast Segmental Retaining Wall Units**

Conforms to:

- C140 for Absorption and Compressive Strength > 3000 PSI
- C1262 for Freeze Thaw Durability <1% mass loss
- C1372 Overall dimensional variations permissible for width, height and length +/-3 mm

**Unilock standards exceed 5,000 PSI for DuraHold® products with:**

- 4% absorption avg.
  - 5% absorption max.
  - Dimensional Accuracy +/-3 mm
- Test results available upon request*

**Meets the U.S. Architectural & Transportation Barrier Compliance Board Slip-Resistance Surfaces Advisory Guidelines**

**LEED INFORMATION**

**Materials & Resources: LEED V4:**

- Building Product Disclosure and Optimization
- Sourcing of Raw Materials - Sourcing of Raw Materials and Extraction • **1 point**
- Sourcing of Raw Materials - Leadership Extraction Practices • **1 point**
- Material Ingredient Reporting - Material Ingredient Reporting • **1 point**
- Material Ingredient Reporting - Material Ingredient Optimization • **1 point**
- Environmental Product Declaration • **1 point**

If required, summary test data shall be provided with the SRW Design and shall include:

- a) SRW Unit shear strength as per ASTM D6916
- b) SRW Unit - Geosynthetic Reinforcement connection strength as per ASTM D6638

**PRODUCT DATA**

Stones & Bundling	Face Feet Per		Linear Feet Per		Units Per		Per Bundle		Lbs Per	
	Bundle	Unit	Bundle	Unit	Bundle	Face Feet	Layers	Sections	Unit	Bundle
<b>Gormley Manufacturing</b>										
Standard	-	6.02	6.02	6.02	2	0.17	-	-	1,680	3,360
Coping	-	6.02	6.02	6.02	2	0.17	-	-	1,560	3,120
Coping Closed End	-	6.02	6.02	6.02	2	0.17	-	-	1,560	3,120
Tie-back	-	2.00	2.00	2.00	2	0.50	-	-	1,660	3,320
½ Standard	-	3.00	3.00	3.00	2	0.33	-	-	800	1,600
½ Coping	-	3.00	3.00	3.00	2	0.33	-	-	780	1,560
Corner 90° Right / Left	-	7.04	-	-	2	0.14	-	-	1,320	2,640
Corner 45° Right / Left	-	7.04	-	-	2	0.14	-	-	1,480	2,960

Notes: \*Closed-end coping units are available and are closed on both ends so that they may be used as left or right. Tie-back units are reinforced with steel. 1/2 Standard units are slightly tapered and can be used to create a 55-foot radius. Please note that 1/2 Coping units are not tapered. Refer to terms and conditions for placement rates. All measurements are nominal. Automatic setback is 1½" per row. Vertical walls may also be constructed. Engineering services are available. For more information, samples or custom options, please contact your Unilock Territory Manager or call 1-800-UNILOCK.

**APPLICATIONS**

 Retaining Walls & Engineered Retaining Walls



Refer to the DuraHold Installation Guide for more information.  
<https://www.risistone.com/installation-guides/>



Clamps available at Unilock. Please contact your Unilock Territory Manager or call 1-800-UNILOCK.

**GEOGRID WALL SECTION**

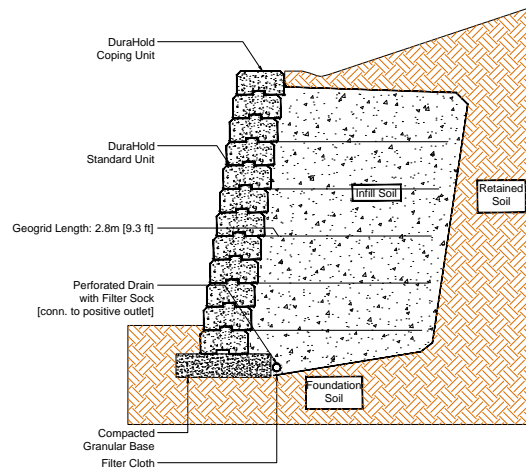

Cross sections are examples, and must not be used for construction.

**\*Things to know:**

Unilock, through **Risi Stone Systems International**, can provide preliminary site engineering for most commercial projects. Soils information, site drawings, and loading requirements are some of the information details required in order to provide this preliminary site engineering. Retaining wall engineering software is also available free of charge. Contact your local Unilock Territory Manager for details.

For more information please visit <https://www.risistone.com/product/durahold/>

WALLS | DURAHOLD®

**RETAINING WALLS & VERTICAL FEATURES**

# DURAHOLD2<sup>®</sup>

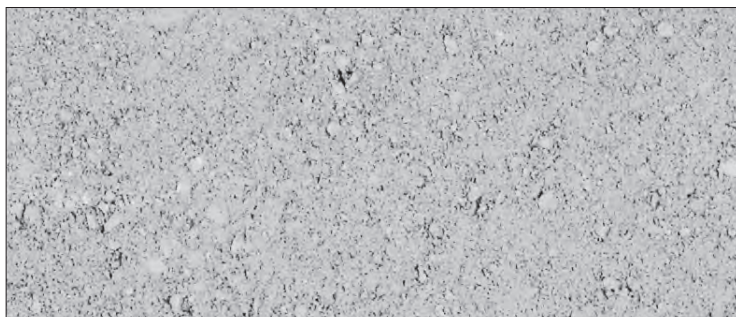

NATURAL

## VISUAL APPEARANCE

DuraHold2<sup>®</sup> is similar to DuraHold<sup>®</sup> in appearance, but is just over half the size, making it economical for low walls. Concrete tie-backs or geogrid reinforcement gives this wall various engineering options.

## FINISH

Standard.

## PRODUCT SPECIFICATIONS



**STANDARD**  
14 x 72 x 12"  
360 x 1830 x 300mm



**COPING**  
14 x 72 x 12"  
360 x 1830 x 300mm



**CLOSED-END COPING**  
14 x 72 x 12"  
360 x 1830 x 300mm



**TIE-BACK**  
14 x 72 x 12"  
360 x 1830 x 300mm

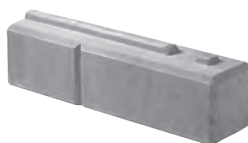

**CORNER 90°**  
14 x 36 x 12"  
360 x 900 x 300mm  
*(Right Corner shown)*



See page 186-187 for more details.

## CROSS SECTIONS

### GRAVITY WALL SECTION

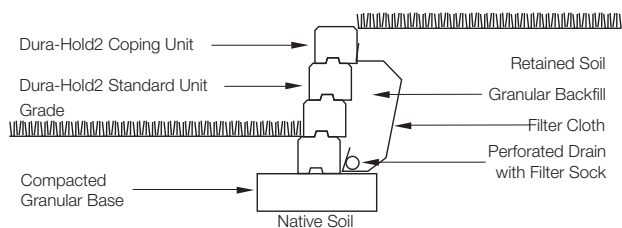

Cross sections are examples, and must not be used for construction.

### GEOGRID WALL SECTION

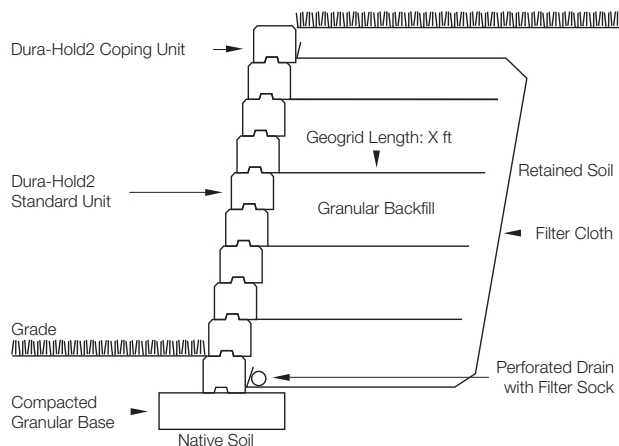

\*Colour selection should be chosen from actual samples.

**TECHNICAL INFORMATION**

**ASTM C 1372 Standard Specifications for Dry-Cast Segmental Retaining Wall Units**

Conforms to:

- C140 for Absorption and Compressive Strength > 3000 PSI
- C1262 for Freeze Thaw Durability <1% mass loss
- C1372 Overall dimensional variations permissible for width, height and length +/-3 mm

**Unilock standards exceed 5,000 PSI for DuraHold® products with:**

- 4% absorption avg.
  - 5% absorption max.
  - Dimensional Accuracy +/-3 mm
- Test results available upon request*

**Meets the U.S. Architectural & Transportation Barrier Compliance Board Slip-Resistance Surfaces Advisory Guidelines**

**LEED INFORMATION**

**Materials & Resources: LEED V4:**

- Building Product Disclosure and Optimization
- Sourcing of Raw Materials - Sourcing of Raw Materials and Extraction • **1 point**
- Sourcing of Raw Materials - Leadership Extraction Practices • **1 point**
- Material Ingredient Reporting - Material Ingredient Reporting • **1 point**
- Material Ingredient Reporting - Material Ingredient Optimization • **1 point**
- Environmental Product Declaration • **1 point**

If required, summary test data shall be provided with the SRW Design and shall include:

- a) SRW Unit shear strength as per ASTM D6916
- b) SRW Unit - Geosynthetic Reinforcement connection strength as per ASTM D6638

**PRODUCT DATA**

Stones & Bundling	Face Feet Per		Linear Feet Per		Units Per		Per Bundle		Lbs Per	
	Bundle	Unit	Bundle	Unit	Bundle	Face Feet	Layers	Sections	Unit	Bundle
<b>Gormley Manufacturing</b>										
Standard	24.10	6.02	24.10	6.02	4	0.17	-	-	938	3,752
Coping 72"	24.10	6.02	24.10	6.02	4	0.17	-	-	884	3,536
Coping Closed End 72"	24.10	6.02	24.10	6.02	4	0.17	-	-	884	3,536
Tie-back	4.68	1.17	-	-	4	0.86	-	-	938	3,752
Corner 90° Right / Left	16.67	4.17	-	-	4	0.24	-	-	460	1,840

Notes: \*Closed-end coping units are available and are closed on both ends so that they may be used as left or right. Tie-back units are reinforced with steel. Refer to terms and conditions for placement rates. All measurements are nominal. Automatic setback is 1½" per row. Engineering services are available. For more information, samples or custom options, please contact your Unilock Territory Manager or call 1-800-UNILOCK.

**APPLICATIONS**

 Retaining Walls & Engineered Retaining Walls



Refer to the DuraHold Installation Guide for more information.  
<https://www.risistone.com/installation-guides/>



Clamps available at Unilock. Please contact your Unilock Territory Manager or call 1-800-UNILOCK.

**GEOGRID WALL SECTION**

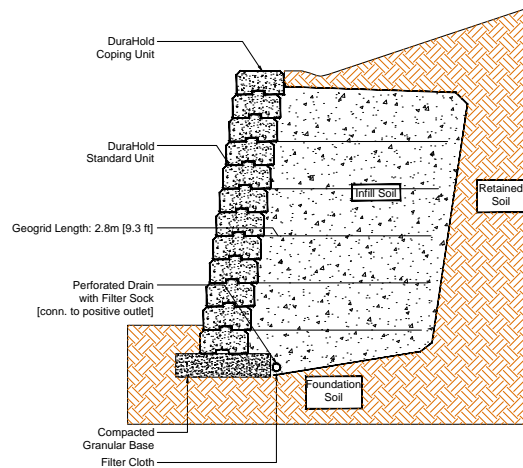

Cross sections are examples, and must not be used for construction.

**\*Things to know:**

For DuraHold® and DuraHold2®, Unilock, through **Risi Stone Systems International**, can provide preliminary site engineering for most commercial projects. Soils information, site drawings, and loading requirements are some of the information details required in order to provide this preliminary site engineering. Retaining wall engineering software is also available free of charge. Contact your local Unilock Territory Manager for details.

**For more information please visit <https://www.risistone.com/product/durahold2/>.**

WALLS | DURAHOLD2®

**RETAINING WALLS & VERTICAL FEATURES**

# LINEO™ DIMENSIONAL STONE

## CLASSIC

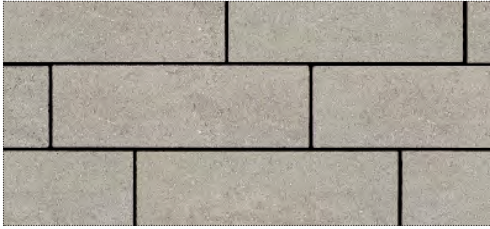
DUSK **NEW**

GRANITE BLEND



MIDNIGHT CHARCOAL

SAFARI **NEW**

### VISUAL APPEARANCE

Contemporary and sleek lines define Lineo™ Dimensional Stone with a linear multi-length plank look. Ideal for garden walls, pillars and other outdoor vertical elements, Lineo™ Dimensional Stone offers up modern design and exceptional flexibility.

### FINISH

Standard.

### PRODUCT SPECIFICATIONS

**XL RECTANGLE**

8 x 24 x 4"  
200 x 600 x 100mm

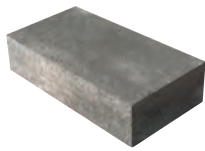
**LARGE RECTANGLE**

8 x 20 x 4"  
200 x 500 x 100mm

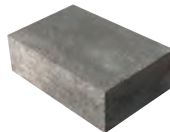
**RECTANGLE**

8 x 16 x 4"  
200 x 400 x 100mm

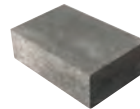
**SMALL RECTANGLE**

8 x 12 x 4"  
200 x 300 x 100mm

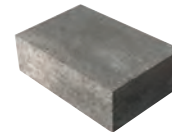
**CORNER/PILLAR UNIT**

8 x 16 x 4"  
200 x 400 x 100mm

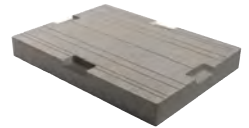
**U-GRIP™ BASE PAD**

14 x 19 x 2"  
355 x 482 x 55mm

4 UNIT RANDOM BUNDLE



- Creates a revolutionary Reinforced Soil Structure (RSS) with high tensile and compressive strength to maximize the performance of pavement structures.
- Extremely permeable, long lasting, durable and environmentally friendly. Lightweight and easy to handle.
- Simple and quick installation.
- Allows for easy repairs / adjustments after installation.

See page 186-187 for more details.

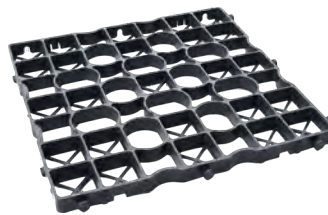

**DRIVECEL30 LIGHT DUTY**  
20 x 20 x 1.2"  
500 x 500 x 30mm

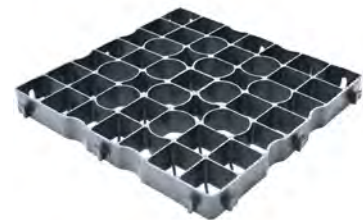

**DRIVECEL50 HEAVY DUTY**  
20 x 20 x 2"  
500 x 500 x 50mm

\*Colour selection should be chosen from actual samples.

**TECHNICAL INFORMATION**

**ASTM C 1372 Standard Specifications for Dry-Cast Segmental Retaining Wall Units**

- Conforms to:
- C140 for Absorption and Compressive Strength > 3000 PSI
  - C1262 for Freeze Thaw Durability <1% mass loss
  - C1372 Overall dimensional variations permissible for width, height and length +/- 3.2mm

**Unilock standards exceed 6,000 PSI for Lineo™ Dimensional Stone products with:**

- 4% absorption avg.
  - 5% absorption max.
  - Dimensional Accuracy +/-2.00mm
- Test results available upon request*

**Meets the U.S. Architectural & Transportation Barrier Compliance Board Slip-Resistance Surfaces Advisory Guidelines**

**LEED INFORMATION**

**Materials & Resources: LEED V4:**

- Building Product Disclosure and Optimization
- Sourcing of Raw Materials - Sourcing of Raw Materials and Extraction • **1 point**
- Sourcing of Raw Materials - Leadership Extraction Practices • **1 point**
- Material Ingredient Reporting - Material Ingredient Reporting • **1 point**
- Material Ingredient Reporting - Material Ingredient Optimization • **1 point**
- Environmental Product Declaration • **1 point**

**PRODUCT DATA**

Stones & Bundling	Face Feet Per		Linear Feet Per		Units Per		Per Bundle		Lbs Per	
	Bundle	Unit	Bundle	Unit	Bundle	Face Feet	Layers	Sections	Unit	Bundle
<b>Gormley Manufacturing / Pillars Caps - Georgetown Manufacturing; U-Grip - Gormley Manufacturing</b>										
Random Wall Bundle:	29.93	-	89.06	-	63	-	3	-	43	2,738
XL Rectangle	7.97	0.66	23.71	1.98	12	1.51	-	-	-	-
Large Rectangle	6.65	0.55	19.78	1.65	12	1.81	-	-	-	-
Rectangle	9.31	0.44	27.72	1.32	21	2.25	-	-	-	-
Small Rectangle	6.00	0.33	17.86	0.99	18	3.00	-	-	-	-
Pillar Unit	39.84	0.66	79.20	1.32	60	1.51	-	-	41	2,435
Ledgestone Pillar Cap	-	-	-	-	5	-	-	-	302	1,510
U-Grip Base Pad	-	-	85.39	1.58	54	-	9	-	46	2,500

Notes: Product sold in full bundles on a refundable skid. Maximum height – 24" (under optimum conditions). All measurements are nominal. Spacing strips are shipped with random wall bundles to create even spacing between units. Free standing wall and is limited to not exceed 24" in height. For more information, samples or custom options, please contact your Unilock Territory Manager or call 1-800-UNILOCK.

**APPLICATIONS**

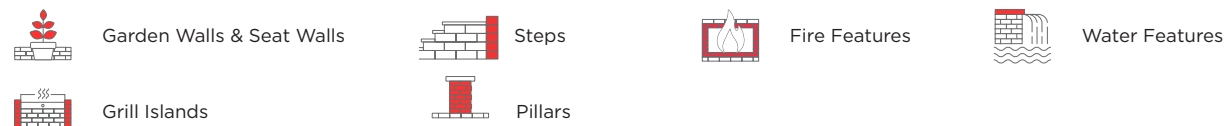

For coping options, we recommend using Ledgestone™, Natural Stone, Universal Coping or Umbriano® Coping.

**RECOMMENDED ADHESIVE**

**Alliance Gator Block Bond XP**

- | VOC Compliant
- | Low odour- safe indoors or out
- | Fast curing- provides permanent overnight bond
- | Suitable for use in hot and cold environments
- | Non-shrinking- does not crack
- | Strong and versatile

Coverage: For 1/4" Bead (approx)

10 oz		28 oz	
m	ft.	m	ft.
-9	-31	-26	-86

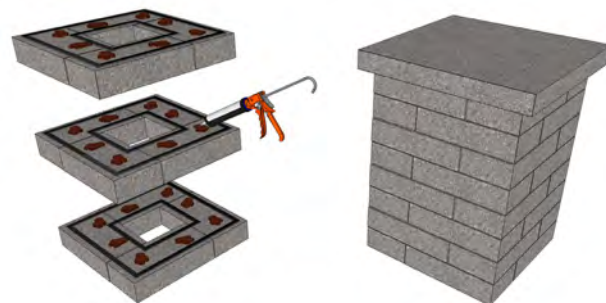

\* Spacers required

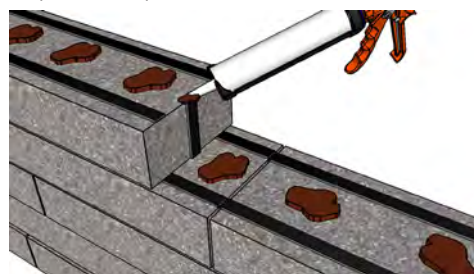

\* Spacers required

WALLS | LINEO™ DIMENSIONAL STONE

RETAINING WALLS & VERTICAL FEATURES

# PISA™ CLASSIC



GRANITE



MAHOGANY



NATURAL



SIERRA

## VISUAL APPEARANCE

The built-in setback design of PISA™ automatically forms the correct slope, ensuring a highly stable retaining wall. Utilizing the product's tapered components, you can form curved walls and steps. Classic tongue and groove for easy install.

## FINISH

Split / Rock-faced.

## PRODUCT SPECIFICATIONS



**STANDARD**  
12 x 8 x 6"  
300 x 200 x 150mm



**TAPERED**  
12 x 8 x 6"  
300 x 200 x 150mm



**CORNER**  
12 x 8 x 6"  
300 x 200 x 150mm



**PISA COPING**  
12 x 24 x 3"  
300 x 600 x 75mm  
*See Steps, Treads & Coping section  
page 166 for more details*

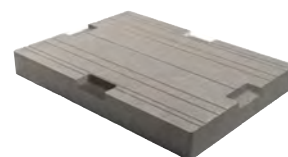

**U-GRIP™ BASE PAD**  
14 x 19 x 2"  
355 x 482 x 55mm



- Creates a revolutionary Reinforced Soil Structure (RSS) with high tensile and compressive strength to maximize the performance of pavement structures.
- Extremely permeable, long lasting, durable and environmentally friendly. Lightweight and easy to handle.
- Simple and quick installation.
- Allows for easy repairs / adjustments after installation.

See page 186-187 for more details.

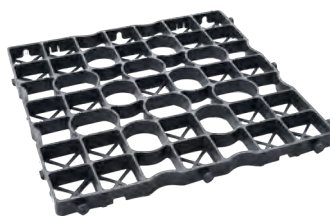

**DRIVECEL30 LIGHT DUTY**  
20 x 20 x 1.2"  
500 x 500 x 30mm

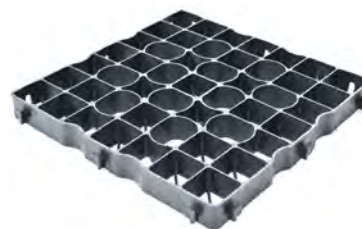

**DRIVECEL50 HEAVY DUTY**  
20 x 20 x 2"  
500 x 500 x 50mm

\*Colour selection should be chosen from actual samples.



**TECHNICAL INFORMATION**

**ASTM C 1372 Standard Specifications for Dry-Cast Segmental Retaining Wall Units**

- Conforms to:
- C140 for Absorption and Compressive Strength > 3000 PSI
  - C1262 for Freeze Thaw Durability <1% mass loss
  - C1372 Overall dimensional variations permissible for width, height and length +/-3 mm

**Unilock standards exceed 5,000 PSI for Pisa™ products with:**

- 4% absorption avg.
  - 5% absorption max.
  - Dimensional Accuracy +/-3 mm
- Test results available upon request*

**Meets the U.S. Architectural & Transportation Barrier Compliance Board Slip-Resistance Surfaces Advisory Guidelines**

**LEED INFORMATION**

**Materials & Resources: LEED V4:**

- Building Product Disclosure and Optimization  
 Sourcing of Raw Materials - Sourcing of Raw Materials and Extraction • **1 point**  
 Sourcing of Raw Materials - Leadership Extraction Practices • **1 point**  
 Material Ingredient Reporting - Material Ingredient Reporting • **1 point**  
 Material Ingredient Reporting - Material Ingredient Optimization • **1 point**  
 Environmental Product Declaration • **1 point**

If required, summary test data shall be provided with the SRW Design and shall include:

- SRW Unit shear strength as per ASTM D6916
- SRW Unit - Geosynthetic Reinforcement connection strength as per ASTM D6638

**PRODUCT DATA**

Stones & Bundling	Face Feet Per		Linear Feet Per		Units Per		Per Bundle		Lbs Per	
	Bundle	Unit	Bundle	Unit	Bundle	Face Feet	Layers	Sections	Unit	Bundle
<b>Gormley Manufacturing; U-Grip - Gormley Manufacturing</b>										
Standard - Pre Split - Single Piece	24.00	0.33	47.90	0.67	72	3.00	-	4	48	3,456
Tapered - Double Unit	20.00	0.67	40.00	1.33	30	1.50	-	2	93	2,775
Corner Unit - Double Unit	20.00	1.67	-	-	12	0.60	-	2	96	1,152
PISA Coping Unit - sold as a double unit	16.00	1.00	64.00	4.00	16	1.00	9	-	145	2,320
U-Grip Base Pad	-	-	85.39	1.58	54	-	9	-	46	2,500

Notes: Sold in full bundles or sections only. Maximum height - 36" (under optimum conditions) but can be engineered for walls that are required to be higher. Higher walls can be achieved using geogrid reinforcement. Tapered units will allow for a minimum 5ft. outside radius. Automatic setback is 3/4" per row. Engineering services are available. For more information, samples or custom options, please contact your Unilock Territory Manager or call 1-800-UNILOCK.

**APPLICATIONS**



Garden Walls & Seat Walls



Retaining Walls



Steps

For coping options, we recommend using Natural Stone, Universal Coping or Pisa2™ Coping.

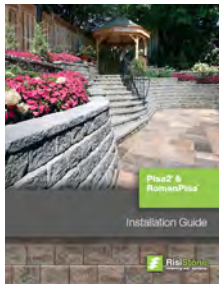

Refer to the Pisa™ Installation Guide for more information.

<https://www.risistone.com/installation-guides/>

**RECOMMENDED ADHESIVE**



**Alliance Gator Block Bond XP**

- | VOC Compliant
- | Low odour- safe indoors or out
- | Fast curing- provides permanent overnight bond
- | Suitable for use in hot and cold environments
- | Non-shrinking- does not crack
- | Strong and versatile

Coverage: For 1/4" Bead (approx)

10 oz		28 oz	
m	ft.	m	ft.
-9	-31	-26	-86

**GRAVITY WALL SECTION**

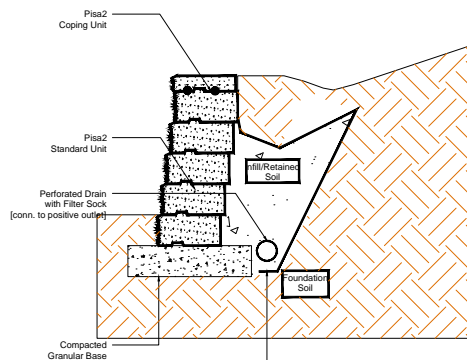

Cross sections are examples, and must not be used for construction.

**GEOGRID WALL SECTION**

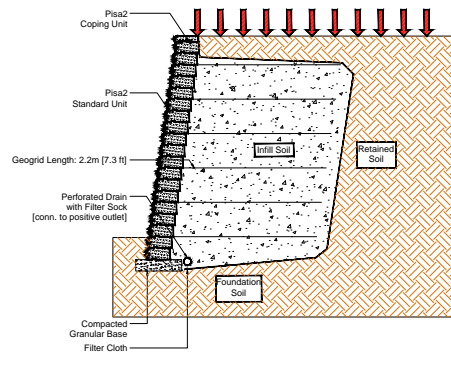

Cross sections are examples, and must not be used for construction.

WALLS | PISA2™

**RETAINING WALLS & VERTICAL FEATURES**

# PISA SMOOTH™

## CLASSIC



CLIFFSIDE GREY



GRANITE BLEND



IRISH COAST

### VISUAL APPEARANCE

A sleek, linear aesthetic with clean lines and subtle edge details that blend well with both modern and traditional design.

### FINISH

Smooth, linear appearance.

### PRODUCT SPECIFICATIONS



**STANDARD**  
 $10\frac{7}{8} \times 21\frac{3}{4} \times 3\frac{3}{8}$ "  
 275 x 550 x 85mm



**COPING**  
 $13\frac{7}{8} \times 21\frac{3}{4} \times 3\frac{3}{8}$ "  
 350 x 550 x 85mm  
*See Steps, Treads & Coping section  
 page 167 for more details*



**CORNER/PILLAR UNIT**  
 $10\frac{7}{8} \times 21\frac{3}{4} \times 3\frac{3}{8}$ "  
 275 x 550 x 85mm

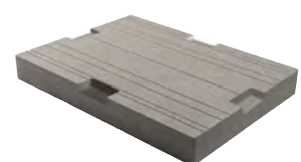

**U-GRIP™ BASE PAD**  
 14 x 19 x 2"  
 355 x 482 x 55mm



- Creates a revolutionary Reinforced Soil Structure (RSS) with high tensile and compressive strength to maximize the performance of pavement structures.
- Extremely permeable, long lasting, durable and environmentally friendly. Lightweight and easy to handle.
- Simple and quick installation.
- Allows for easy repairs / adjustments after installation.

See page 186-187 for more details.

\*Colour selection should be chosen from actual samples.

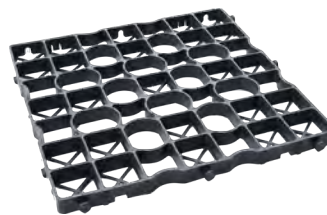

**DRIVECEL30 LIGHT DUTY**  
 20 x 20 x 1.2"  
 500 x 500 x 30mm

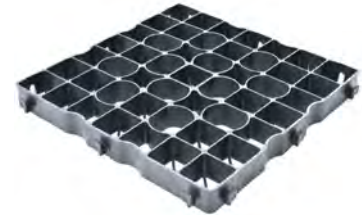

**DRIVECEL50 HEAVY DUTY**  
 20 x 20 x 2"  
 500 x 500 x 50mm

**TECHNICAL INFORMATION**

**ASTM C 1372 Standard Specifications for Dry-Cast Segmental Retaining Wall Units**

- Conforms to:
- C140 for Absorption and Compressive Strength > 3000 PSI
  - C1262 for Freeze Thaw Durability <1% mass loss
  - C1372 Overall dimensional variations permissible for width, height and length +/- 1/8" (+/-3 mm)

**Unilock standards exceed 5,000 PSI for Pisa<sup>2</sup> Smooth products with:**

- 4% absorption avg.
  - 5% absorption max.
  - Dimensional Accuracy +/- 1/8" (+/-3 mm)
- Test results available upon request*

**Meets the U.S. Architectural & Transportation Barrier Compliance Board Slip-Resistance Surfaces Advisory Guidelines**

**LEED INFORMATION**

**Materials & Resources: LEED V4:**

- Building Product Disclosure and Optimization  
 Sourcing of Raw Materials - Sourcing of Raw Materials and Extraction • **1 point**  
 Sourcing of Raw Materials - Leadership Extraction Practices • **1 point**  
 Material Ingredient Reporting - Material Ingredient Reporting • **1 point**  
 Material Ingredient Reporting - Material Ingredient Optimization • **1 point**  
 Environmental Product Declaration • **1 point**

If required, summary test data shall be provided with the SRW Design and shall include:

- SRW Unit shear strength as per ASTM D6916
- SRW Unit - Geosynthetic Reinforcement connection strength as per ASTM D6638

**PRODUCT DATA**

Stones & Bundling	Face Feet Per		Linear Feet Per		Units Per		Per Bundle		Lbs Per	
	Bundle	Unit	Bundle	Unit	Bundle	Layer	Layers	Sections	Unit	Bundle
<b>Gormley Manufacturing; U-Grip - Gormley Manufacturing</b>										
Standard	24.18	0.50	86.64	1.805	48	8	6	4	48.14	2,311
Corner Unit	36.24	0.76	129.9	2.71	48	8	6	2	60	2,880
Coping Unit	18.12	0.76	64.96	2.71	36	6	6	1	76.74	2,763
U-Grip Base Pad	-	-	85.39	1.58	54	-	9	-	46	2,500

Notes: Sold in full bundles only. Maximum height - 36" (under optimum conditions) but can be engineered for walls that require to be higher. Higher walls can be achieved using geogrid reinforcement. Automatic setback is 3/4" per row. Engineering services are available. For more information, samples or custom options, please contact your Unilock Territory Manager or call 1-800-UNILOCK.

**APPLICATIONS**



Garden Walls & Seat Walls



Retaining Walls



Steps

For coping options, we recommend using LedgeStone™, Natural Stone, Universal Coping or Pisa Smooth™ Coping.

**RECOMMENDED ADHESIVE**

**Alliance Gator Block Bond XP**

- VOC Compliant
- Low odour- safe indoors or out
- Fast curing- provides permanent overnight bond
- Suitable for use in hot and cold environments
- Non-shrinking- does not crack
- Strong and versatile
- Coverage: For 1/4" Bead (approx)**

10 oz		28 oz	
m	ft.	m	ft.
-9	-31	-26	-86

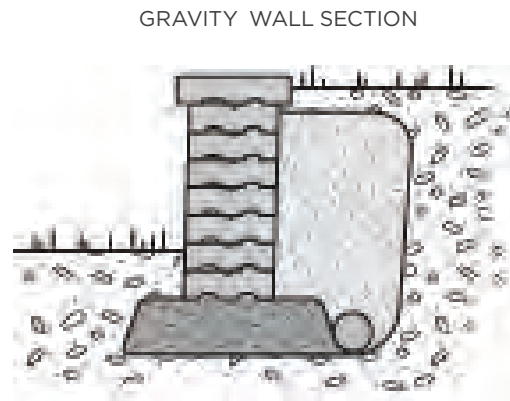
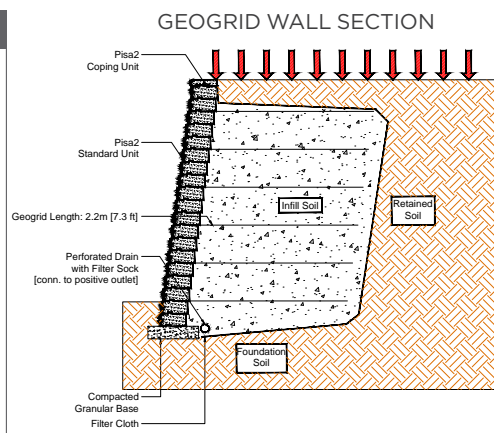

Cross sections are examples, and must not be used for construction.

WALLS | PISA SMOOTH™

**RETAINING WALLS & VERTICAL FEATURES**

# SIENASTONE™

## CLASSIC

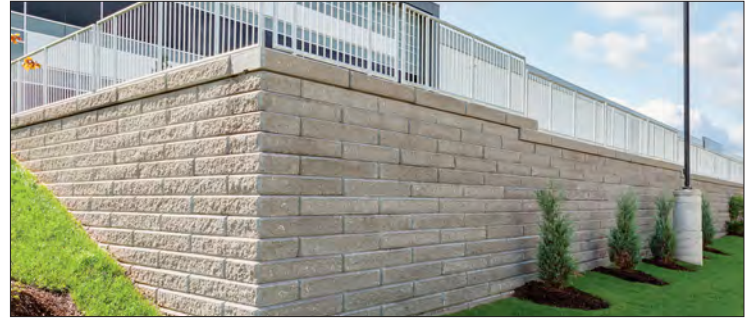

NATURAL

### VISUAL APPEARANCE

Long and linear split faced wall.

### FINISH

Split and weathered.

### PRODUCT SPECIFICATIONS



**STANDARD 925**  
37½ x 47¼ x 7¼"  
925 x 1200 x 185mm



**STANDARD 500**  
20 x 47¼ x 7¼"  
500 x 1200 x 185mm



**STANDARD 333**  
13 x 47¼ x 7¼"  
333 x 1200 x 185mm



**CORNER 45° (left & right)**  
20 x 43½ x 7¼"  
500 x 1100 x 185mm



**CORNER 90° (left & right)**  
20 x 43½ x 7¼"  
500 x 1100 x 185mm



**COPING**  
20 x 47¼ x 7¼"  
500 x 1200 x 185mm



**CLOSED- END COPING**  
20 x 47¼ x 7¼"  
500 x 1200 x 185mm



**VERTICAL 500**  
20 x 47¼ x 7¼"  
500 x 1200 x 185mm  
*Special Order only*



**VERTICAL 925**  
37½ x 47¼ x 7¼"  
925 x 1200 x 185mm  
*Special Order only*

*See Steps, Treads & Coping section page 176 for more SienaStone Steps*



See page 186-187 for more details.

### CROSS SECTIONS

#### GRAVITY WALL SECTION

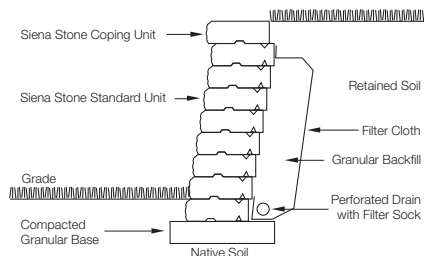

#### VERTICAL WALL SECTION

Note:  
Extra care must be taken when constructing vertical walls.  
Please contact Risi Stone Inc. for information on proper construction techniques.

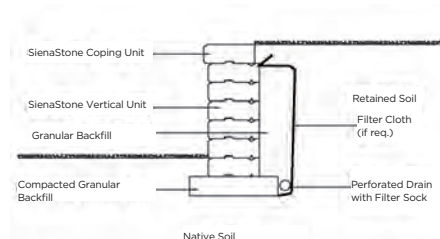

#### GRAVITY 500 AND 925 WALL SECTION

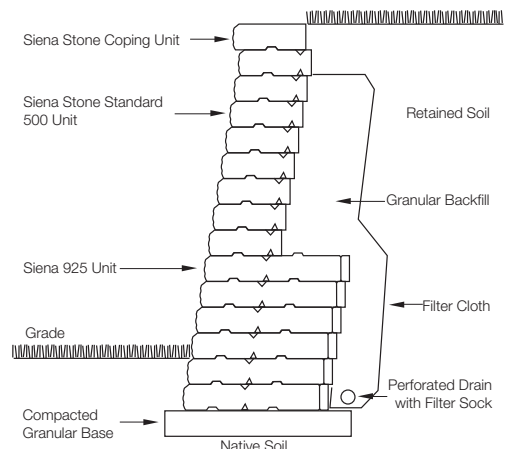

\*Colour selection should be chosen from actual samples.

**TECHNICAL INFORMATION**

**ASTM C 1372 Standard Specifications for Dry-Cast Segmental Retaining Wall Units**

- Conforms to:
- C140 for Absorption and Compressive Strength > 3000 PSI
  - C1262 for Freeze Thaw Durability <1% mass loss
  - C1372 Overall dimensional variations permissible for width, height and length +/-3 mm

**Unilock standards exceed 5,000 PSI for SienaStone™ products with:**

- 4% absorption avg.
  - 5% absorption max.
  - Dimensional Accuracy +/-3 mm
- Test results available upon request*

**Meets the U.S. Architectural & Transportation Barrier Compliance Board Slip-Resistance Surfaces Advisory Guidelines**

**LEED INFORMATION**

**Materials & Resources: LEED V4:**

- Building Product Disclosure and Optimization  
 Sourcing of Raw Materials - Sourcing of Raw Materials and Extraction • **1 point**  
 Sourcing of Raw Materials - Leadership Extraction Practices • **1 point**  
 Material Ingredient Reporting - Material Ingredient Reporting • **1 point**  
 Material Ingredient Reporting - Material Ingredient Optimization • **1 point**  
 Environmental Product Declaration • **1 point**

If required, summary test data shall be provided with the SRW Design and shall include:

- SRW Unit shear strength as per ASTM D6916
- SRW Unit - Geosynthetic Reinforcement connection strength as per ASTM D6638

**PRODUCT DATA**

Stones & Bundling	Face Feet Per		Linear Feet Per		Units Per		Per Bundle		Lbs Per	
	Bundle	Unit	Bundle	Unit	Bundle	Face Feet	Layers	Sections	Unit	Bundle
<b>Gormley Manufacturing</b>										
Standard 333	21.63	2.40	36.00	4.00	9	0.42	3	-	380	3,420
Standard 500	14.28	2.38	24.00	4.00	6	0.42	3	-	570	3,420
Standard 925	7.21	2.40	12.00	4.00	3	0.42	3	-	1,140	3,420
Coping 48"	14.42	2.40	24.00	4.00	6	0.42	3	-	570	3,420
Coping Closed End 48"	14.28	2.38	24.00	4.00	6	0.42	3	-	570	3,420
Corner 90° - Double Unit	19.11	6.37	-	-	3	0.16	3	-	1,140	3,420
Corner 45° - Double Unit	19.11	6.37	-	-	3	0.16	3	-	1,050	3,150

Notes: Only Closed-end Coping units are available in colour. Closed-end coping is available rock faced on the end upon request. An additional cost applies to rock facing units and 48 hours notice for rock facing units is required. Coloured closed-end coping units can be used to construct steps. \*SienaStone™ corners are sold as double units - one left and one right. Wall units are only stocked in Natural. Vertical units are also available. Automatic setback is 1" per row. Engineering services are available. For more information, samples or custom options, please contact your Unilock Territory Manager or call 1-800-UNILOCK.

**APPLICATIONS**



Garden Walls & Seat Walls



Retaining Walls



Steps



Refer to the SienaStone™ Installation Guide for more information.

<https://www.risistone.com/installation-guides/>



Clamps available at Unilock. Please contact your Unilock Territory Manager or call 1-800-UNILOCK.

**GEOGRID CROSS SECTION**

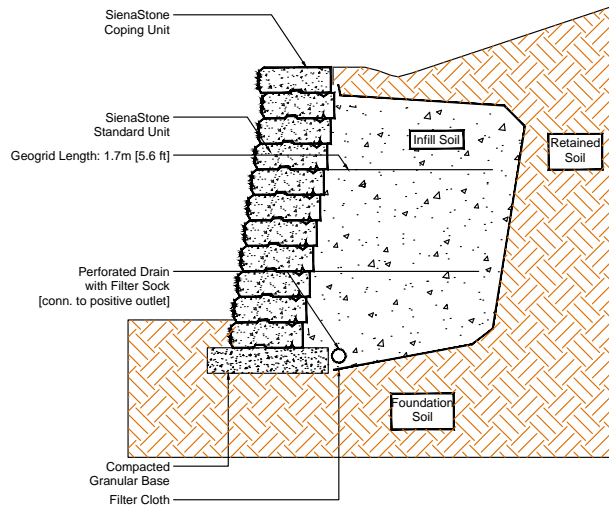

Cross sections are examples, and must not be used for construction.

WALLS | SIENASTONE™

RETAINING WALLS & VERTICAL FEATURES

**\*Things to know:**

For SienaStone™, Unilock, through **Risi Stone Systems International**, can provide preliminary site engineering for most commercial projects. Soils information, site drawings, and loading requirements are some of the information details required in order to provide this preliminary site engineering.

Retaining wall engineering software is also available free of charge. Contact your local Unilock Territory Manager for details.

**For more information please visit <https://www.risistone.com/product/sienastone/>**

# SIENASTONE™ SMOOTH

## CLASSIC



GRANITE BLEND

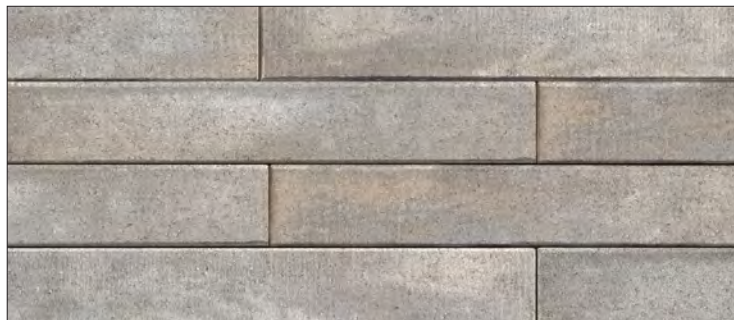

SAFARI **NEW**

### VISUAL APPEARANCE

A more modern, clean looking solution for heavy-duty walls.

### FINISH

Smooth, linear look.

### PRODUCT SPECIFICATIONS



**STANDARD 375**  
14¾ x 47¼ x 7"  
375 x 1200 x 180mm



**CORNER UNIT 375**  
14¾ x 38⅝ x 7"  
375 x 1200 x 180mm



**COPING 383**  
15 x 47¼ x 7"  
383 x 1200 x 180mm



**CLOSED END COPING LEFT/RIGHT**  
15 x 47¼ x 7"  
383 x 1200 x 180mm

*See Steps, Treads & Coping section page 177 for SienaStone Smooth Steps*



- Creates a revolutionary Reinforced Soil Structure (RSS) with high tensile and compressive strength to maximize the performance of pavement structures.
- Extremely permeable, long lasting, durable and environmentally friendly. Lightweight and easy to handle.
- Simple and quick installation.
- Allows for easy repairs / adjustments after installation.

See page 186-187 for more details.

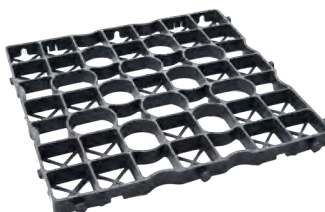

**DRIVECEL30 LIGHT DUTY**  
20 x 20 x 1.2"  
500 x 500 x 30mm

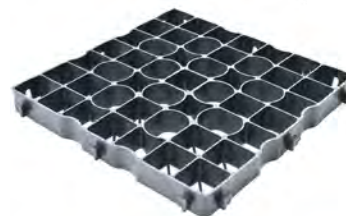

**DRIVECEL50 HEAVY DUTY**  
20 x 20 x 2"  
500 x 500 x 50mm

\*Colour selection should be chosen from actual samples.

**TECHNICAL INFORMATION**

**ASTM C 1372 Standard Specifications for Dry-Cast Segmental Retaining Wall Units**

- Conforms to:
- C140 for Absorption and Compressive Strength > 3000 PSI
  - C1262 for Freeze Thaw Durability <1% mass loss
  - C1372 Overall dimensional variations permissible for width, height and length +/-3 mm

**Unilock standards exceed 5,000 PSI for SienaStone™ Smooth**

- 4% absorption avg.
  - 5% absorption max.
  - Dimensional Accuracy +/-3 mm
- Test results available upon request*

**Meets the U.S. Architectural & Transportation Barrier Compliance Board Slip-Resistance Surfaces Advisory Guidelines**

**LEED INFORMATION**

**Materials & Resources: LEED V4:**

- Building Product Disclosure and Optimization
- Sourcing of Raw Materials - Sourcing of Raw Materials and Extraction • **1 point**
- Sourcing of Raw Materials - Leadership Extraction Practices • **1 point**
- Material Ingredient Reporting - Material Ingredient Reporting • **1 point**
- Material Ingredient Reporting - Material Ingredient Optimization • **1 point**
- Environmental Product Declaration • **1 point**

If required, summary test data shall be provided with the SRW Design and shall include:

- SRW Unit shear strength as per ASTM D6916
- SRW Unit - Geosynthetic Reinforcement connection strength as per ASTM D6638

**PRODUCT DATA**

Stones & Bundling	Face Feet Per		Linear Feet Per		Units Per		Per Bundle		Lbs Per	
	Bundle	Unit	Bundle	Unit	Bundle	Face Feet	Layers	Sections	Unit	Bundle
<b>Gormley Manufacturing</b>										
Standard 375	20.93	2.33	36.00	4.00	9	0.43	3	-	394	3,546
Coping	20.93	2.33	36.00	4.00	9	0.43	3	-	395	3,555
Corner Unit (double unit)	27.27	3.03	46.71	5.19	3	0.33	3	-	407	3,665
Closed end Coping (left & right)	20.93	2.33	36.00	4.00	9	0.43	3	-	395	3,555

Notes: SienaStone™ Smooth corners are sold together as double units, one left and one right. Engineering services are available. For more information, samples or custom options, please contact your Unilock Territory Manager or call 1-800-UNILOCK.

**APPLICATIONS**



Garden Walls & Seat Walls



Retaining Walls



Steps



Refer to the SienaStone™ Installation Guide for more information.

<https://www.risistone.com/installation-guides/>



Clamps available at Unilock. Please contact your Unilock Territory Manager or call 1-800-UNILOCK.

**GEOGRID WALL SECTION**

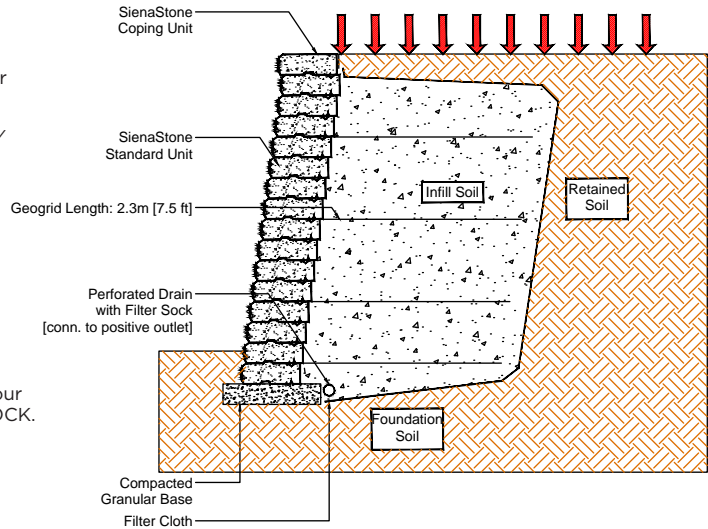

Cross sections are examples, and must not be used for construction.

WALLS | SIENASTONE™ SMOOTH

**RETAINING WALLS & VERTICAL FEATURES**

**\*Things to know:**

For SienaStone™, Unilock, through **Risi Stone Systems International**, can provide preliminary site engineering for most commercial projects. Soils information, site drawings, and loading requirements are some of the information details required in order to provide this preliminary site engineering.

Retaining wall engineering software is also available free of charge. Contact your local Unilock Territory Manager for details.

**For more information please visit <https://www.risistone.com/product/sienastone/>**

# SONOMASTONE™

## CLASSIC



Clamps available at Unilock. Please contact your Unilock Territory Manager or call 1-800-UNILOCK.

NATURAL

### VISUAL APPEARANCE

Heavy Duty Retaining Wall with the appearance of hand-placed units.

### FINISH

Split and weathered.

### PRODUCT SPECIFICATIONS



**STANDARD**  
 $14\frac{3}{4} \times 47\frac{1}{4} \times 7\frac{1}{4}$ "  
 375 x 1200 x 185mm



**COPING**  
 $14\frac{3}{4} \times 47\frac{1}{4} \times 7\frac{1}{4}$ "  
 375 x 1200 x 185mm



**TAPERED STANDARD**  
 $14\frac{3}{4} \times 23\frac{1}{4} \times 7\frac{1}{4}$ "  
 375 x 590 x 185mm



**TAPERED COPING**  
 $14\frac{3}{4} \times 23\frac{1}{4} \times 7\frac{1}{4}$ "  
 375 x 590 x 185mm



**CORNER**  
 $38\frac{3}{8} \times 14\frac{3}{4} \times 7\frac{1}{4}$ "  
 975 x 375 x 185mm



**DOUBLE**  
 $29\frac{1}{2} \times 47\frac{1}{4} \times 7\frac{1}{4}$ "  
 750 x 1200 x 185mm

### GEOGRID WALL SECTION

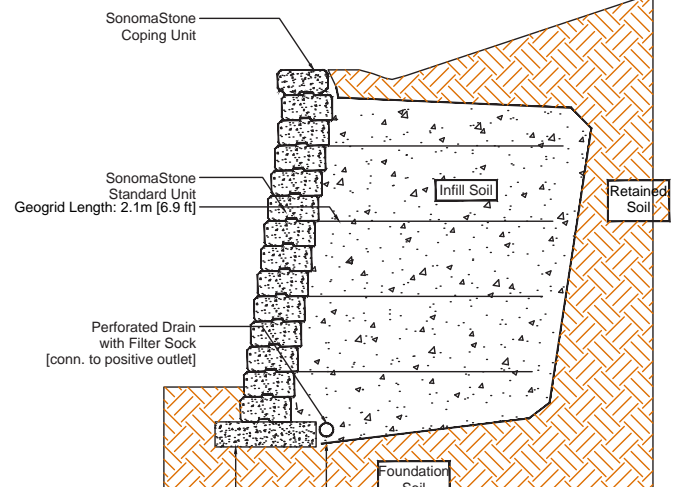

Cross sections are examples, and must not be used for construction.

### GEOGRID INSTALLATION

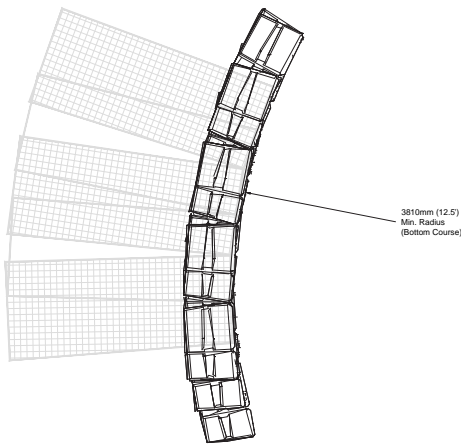

Note:  
 Due to curved orientation, gaps will occur between adjacent section of geogrid. Alternate layers should be placed so they overlap the gaps in lower layers.

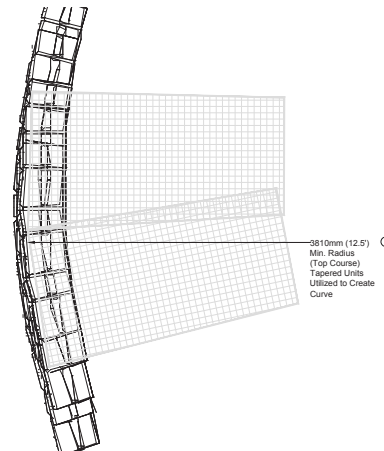

Note:  
 Geogrids will overlap and should have 75mm of compacted soil between the layers. (Geogrids should be spaced on backs so overlap does not occur until geogrid enters soil zone as shown)



See page 186-187 for more details.

\*Colour selection should be chosen from actual samples.





**TECHNICAL INFORMATION**

**ASTM C 1372 Standard Specifications for Dry-Cast Segmental Retaining Wall Units**

Conforms to:

- C140 for Absorption and Compressive Strength > 3000 PSI
- C1262 for Freeze Thaw Durability <1% mass loss
- C1372 Overall dimensional variations permissible for width, height and length +/-3.2mm

**Unilock standards exceed 6,000 PSI for Sonomastone® products with:**

- 4% absorption avg.
  - 5% absorption max.
  - Dimensional Accuracy +/-2.00mm
- Test results available upon request*

**LEED INFORMATION**

**Materials & Resources: LEED V4:**

- Building Product Disclosure and Optimization
- Sourcing of Raw Materials - Sourcing of Raw Materials and Extraction • **1 point**
- Sourcing of Raw Materials - Leadership Extraction Practices • **1 point**
- Material Ingredient Reporting - Material Ingredient Reporting • **1 point**
- Material Ingredient Reporting - Material Ingredient Optimization • **1 point**
- Environmental Product Declaration • **1 point**

**PRODUCT DATA**

Stones & Bundling	Face Feet Per		Linear Feet Per		Units Per		Per Bundle		Lbs Per	
	Bundle	Unit	Bundle	Unit	Bundle	Face Feet	Layers	Sections	Unit	Bundle
<b>Gormley Manufacturing</b>										
Standard	21.63	2.40	36.00	4.00	9	0.42	3	-	386	3,470
Tapered	21.15	1.18	34.80	1.93	18	0.85	3	-	196	3,525
Double Unit	14.42	4.81	3.00	1.00	3	0.21	3	-	1,158	3,473
Coping 48"	21.63	2.40	36.00	4.00	9	0.42	3	-	383	3,450
Coping Tapered 24"	10.50	1.17	17.40	1.93	9	0.86	2	-	180	1,620
Corner Unit (Double Unit)	15.63	5.21	-	-	3	0.19	3	-	716	2,148

Notes: Sonoma Clamp required for installation. Units can be installed three at a time for increased production. \*\*SonomaStone corners are sold as double units - one left and one right. There are 3 Standard units included on a skid of Double Units. The Coping Unit has a smooth finish with a cornice detail. Tapered units achieve a 14" radius. Automatic setback is 1½" per row. For more information, samples or custom options, please contact your Unilock Territory Manager or call 1-800-UNILOCK.

**APPLICATIONS**



TYPICAL DETAIL CORE DRILLED HANDRAIL

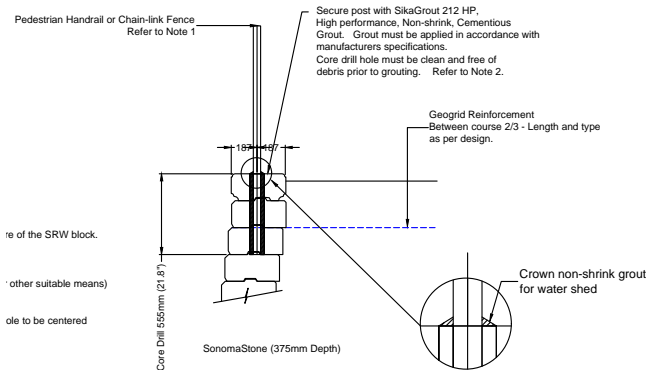

TYPICAL DETAIL PRIVACY FENCE

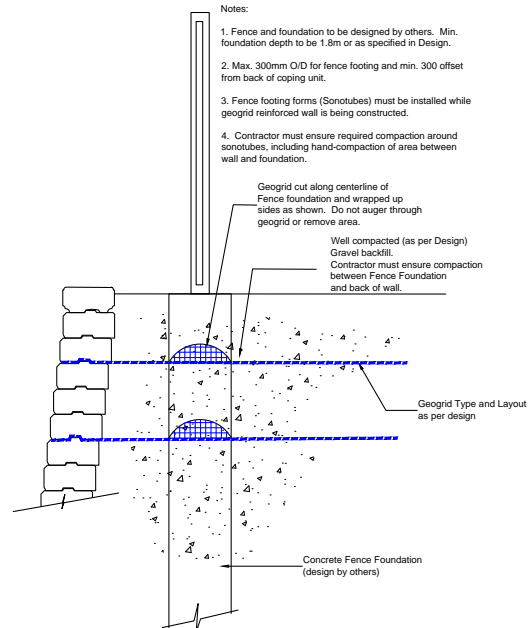

**\*Things to know:**

For SonomaStone®, Unilock, through **Risi Stone Systems International**, can provide preliminary site engineering for most commercial projects. Soils information, site drawings, and loading requirements are some of the information details required in order to provide this preliminary site engineering. Retaining wall engineering software is also available free of charge. Contact your local Unilock Territory Manager for details.

**For more information please visit <https://www.risistone.com/product/sonomastone/>**

WALLS | SONOMASTONE™

**RETAINING WALLS & VERTICAL FEATURES**

# U-CARA<sup>®</sup> MULTI-FACE WALL SYSTEM

Exclusive to **UNILOCK**



## ENDURACOLOR™

### PITCHED FINISH



ALMOND GROVE FUSION



GRANITE MIST

### SERIES™ FINISH



BLACK GRANITE *3" Panel only*

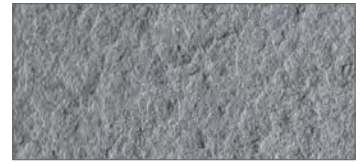

BUCINE BLUESTONE (NATURAL STONE)  
*6" Panel for standard & closed end units*

### SMOOTH FINISH



ALMOND GROVE FUSION



FOSSIL



GRANITE MIST

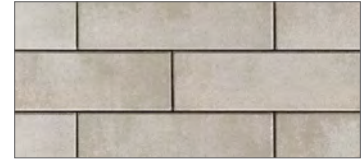

INDIANA BUFF **NEW**

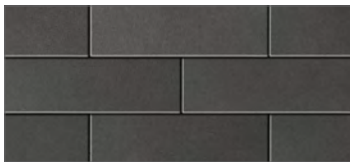

MIDNIGHT CHARCOAL **NEW**

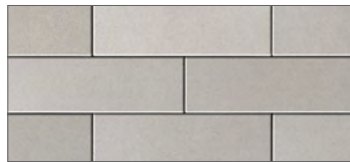

OPAL BLEND

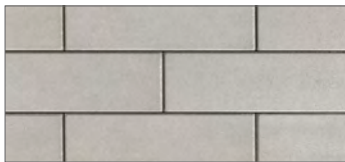

STERLING **NEW**

### UMBRIANO FINISH - SMOOTH FINISH ONLY



FRENCH GREY



MIDNIGHT SKY



SUMMER WHEAT



WINTER MARVEL

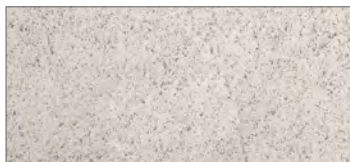

GRENADA WHITE **NEW**

## LAYING PATTERNS



1/2 Running Bond



1/2 Running Bond with Linear Accents



1/2 Running Bond with Paver Accents



Mixed Bond

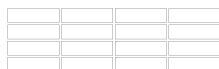

Stacked Bond



Stacked Bond with Accents



1/2 Running Bond with Random Accents



1/3 Running Bond

## VISUAL APPEARANCE

The U-Cara<sup>®</sup> Multi-Face Wall System represents a revolution in wall design. Comprised of 2 basic components: Sure Track Backer Blocks- providing dimensionally accurate structure, and U-CARA fascia panels- providing unlimited design options. U-CARA Wall matches select pavers exactly with the same manufacturing and aggregate blends. Superior pairing from vertical to horizontal landscapes.

## FINISH

Available in Umbriano\* (Smooth Finish only), Smooth Face, Pitched Face and the 3" Panels are available in Series™ finish Black Granite.

\*Colour selection should be chosen from actual samples.

PRODUCT SPECIFICATIONS

1 BASE UNIT



**UNIVERSAL  
BASE UNIT**  
19 x 14 x 2"  
482 x 355 x 55mm

2 BACKER BLOCKS



**SURETRACK  
STANDARD**  
6 x 8 x 6"  
150 x 200 x 150mm



**SURETRACK  
LARGE BACKER  
CORNER/PILLAR**  
6 x 7 x 12"  
150 x 175 x



**SURETRACK  
CORNER INSERT**  
L = 2"  
50mm

3 FASCIA PANELS

6" STANDARD



6 x 18½ x 2⅜"  
150 x 466 x 60mm

3" SERIES PANEL



3 x 9¼ x 2⅜"  
75 x 233 x 60mm

2 UNIT CORNER BUNDLE



**CLOSED-END  
FASCIA PANEL**

6 x 21 x 2⅜"  
150 x 533 x 60mm



**STANDARD FASCIA  
HALF PANEL**

6 x 9¼ x 2⅜"  
150 x 233 x 60mm

4 FASCIA PANEL STYLES



SMOOTH



PITCHED

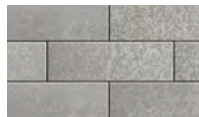

UMBRIANO



SERIES

5 COPING

**ENDURA™ COPING**



SEE PAGE 165

**UMBRIANO COPING**



SEE PAGE 170

**UNIVERSAL COPING**



SEE PAGE 171



See page 186-187 for more details.

- Creates a revolutionary Reinforced Soil Structure (RSS) with high tensile and compressive strength to maximize the performance of pavement structures.
- Extremely permeable, long lasting, durable and environmentally friendly. Lightweight and easy to handle.
- Simple and quick installation.
- Allows for easy repairs / adjustments after installation.

See page 191-192 for more details.

### WALL DETAILS

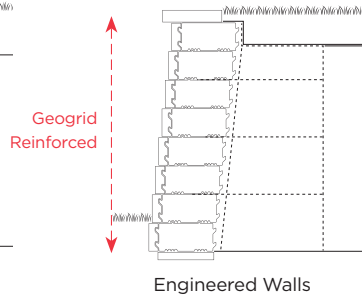
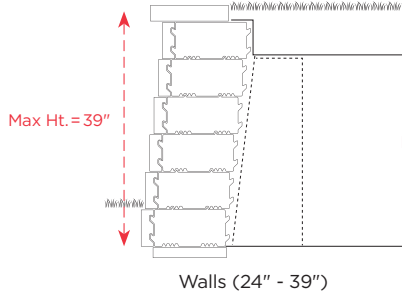
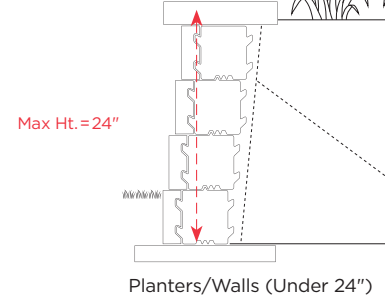
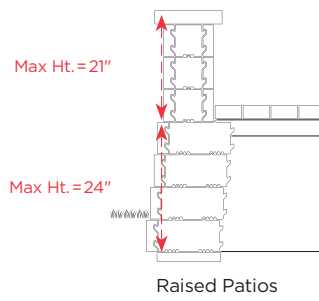
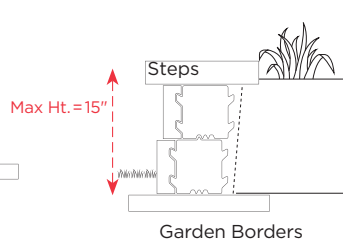
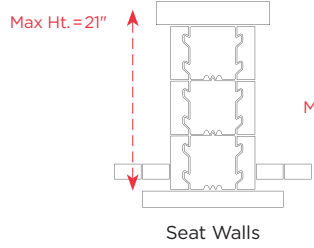

Check out the U-CARA Installation Manual at [unilock.com](http://unilock.com)  
[contractor.unilock.com/installation/literature-downloads/](http://contractor.unilock.com/installation/literature-downloads/)

Our U-Cara Modular System offers a variety of aluminium frames that can be mixed and matched to construct vertical features like grill islands, fire features and pillars.



Check out the U-CARA Modular Fireplace System Manual at [unilock.com](http://unilock.com)  
[contractor.unilock.com/installation/literature-downloads/](http://contractor.unilock.com/installation/literature-downloads/)

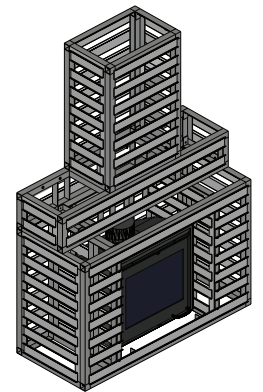
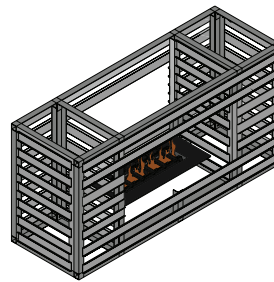
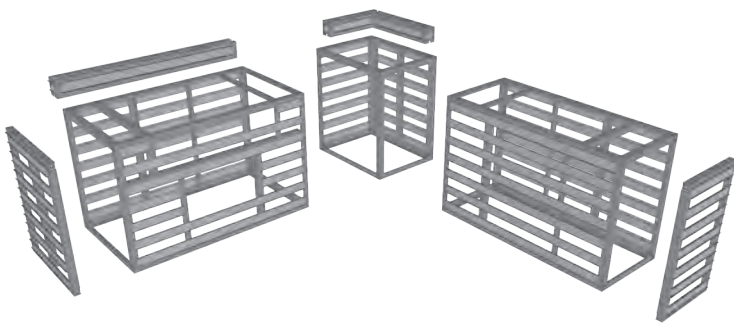

## TECHNICAL INFORMATION

### ASTM C 1372 Standard Specifications for Dry-Cast Segmental Retaining Wall Units

Conforms to:

- C140 for Absorption and Compressive Strength > 3000 PSI
- C1262 for Freeze Thaw Durability <1% mass loss
- C1372 Overall dimensional variations permissible for width, height and length +/-3.2 mm

### Unilock standards exceed 5,500 PSI for U-Cara products with:

- 4% absorption avg.
- 5% absorption max.
- Dimensional Accuracy +/-2 mm

Test results available upon request

## LEED INFORMATION

### Materials & Resources: LEED V4:

Building Product Disclosure and Optimization

Sourcing of Raw Materials - Sourcing of Raw Materials and Extraction • **1 point**

Sourcing of Raw Materials - Leadership Extraction Practices • **1 point**

Material Ingredient Reporting - Material Ingredient Reporting • **1 point**

Material Ingredient Reporting - Material Ingredient Optimization • **1 point**

Environmental Product Declaration • **1 point**

## PRODUCT DATA

Stones & Bundling	Face Feet Per		Linear Feet Per		Units Per		Per Bundle		Lbs Per	
	Bundle	Unit	Bundle	Unit	Bundle	Face Feet	Layers	Sections	Unit	Bundle
<b>Georgetown Manufacturing Umbriano all Fascia's and Corners / Georgetown Manufacturing Smooth &amp; Pitched / Gormley Manufacturing SureTrack Backers</b>										
SureTrack Standard Backer	34.88	0.32	-	-	108	3.10	3	-	23	2,506
SureTrack Large Backer when used as Corner	31.79	0.76	-	-	42	1.32	3	-	36	1,509
SureTrack Large Backer when used as Wall	11.87	0.28	-	-	42	3.54	3	-	36	1,509
Standard Fascia Panel (Smooth) 3" (75mm)	59.32	0.18	256.70	0.76	336	5.66	-	-	4	1,453
Standard Fascia Panel (Smooth) 6" (150mm)	61.52	0.73	127.68	1.52	84	1.37	6	-	18	1,513
Standard Fascia Panel (Pitched) 6" (150mm)	61.52	0.73	127.68	1.52	84	1.37	6	-	21	1,745
Corner Bundle (Smooth)	54.19	-	-	-	84	-	-	-	30	1,240
Closed-End Fascia Panel	38.94	0.93	-	-	42	1.08	-	-	-	-
Half Fascia Panel	15.25	0.36	-	-	42	2.75	-	-	-	-
Corner Bundle (Pitched)	54.19	-	-	-	84	-	-	-	33.69	1,415
Closed-End Fascia Panel	38.94	0.93	-	-	42	1.08	-	-	-	-
Half Fascia Panel	15.25	0.36	-	-	42	2.75	-	-	-	-
Universal Coping Bundle	-	-	75.90	1.58	48	-	-	-	57	2,747
U-GRIP Base Pad	-	-	85.39	1.58	54	-	9	-	46	2,500

Notes: Sold in full bundles only. Product is shipped on skids. Corner Bundle has 24 Right Closed-end units and 18 Left Closed-end units. All measurements are nominal. For more information, samples or custom options, please contact your Unilock Territory Manager or call 1-800-UNILOCK.

## APPLICATIONS



Garden Walls & Seat Walls



Steps



Fire Features



Grill Islands



Retaining Walls



Pillars



Water Features

For coping options, we recommend using Endura, Natural Stone, Universal or Umbriano Coping.

# U-CARA<sup>®</sup> MODULAR SYSTEM



## CONSTRUCT CREATIVE VERTICALS WITH SPEED ACCURACY AND STRENGTH

- GRILL ISLANDS
- BACKSPLASHES
- FIRE TABLES
- PILLARS
- BARS

STRUCTURAL  
**LIFETIME**  
WARRANTY

**6063**  
ALUMINUM  
LIGHT & STRONG

**U-CARA**  
MODULAR  
SYSTEM

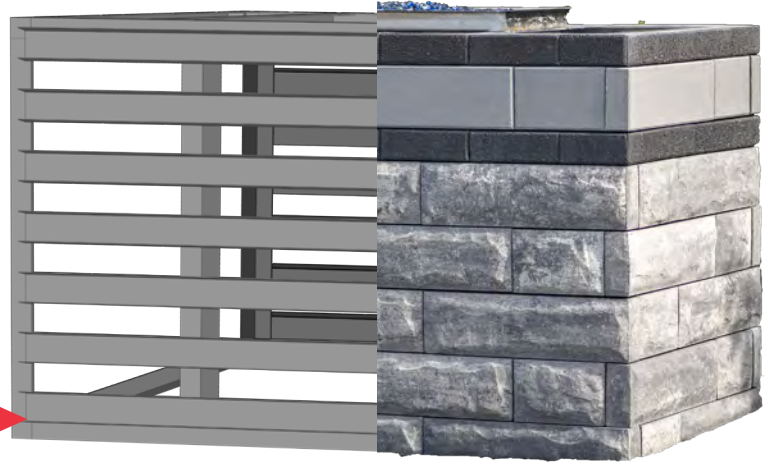

### PRODUCT SPECIFICATIONS

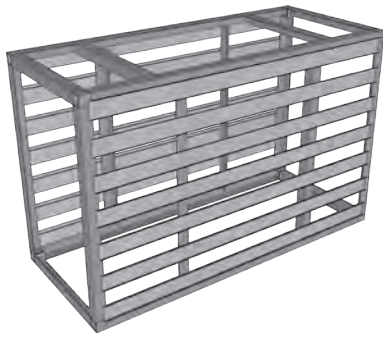

**BASE MODULE**  
Model : U-BC 70  
64½ x 27½ x 41⅞"  
1638 x 699 x 1056mm

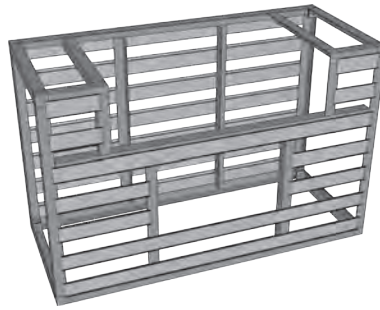

**GRILL MODULE**  
Model : U-GC 70  
64½ x 41⅞"  
1638 x 1056mm  
*\*Depth is determined by End Cap*

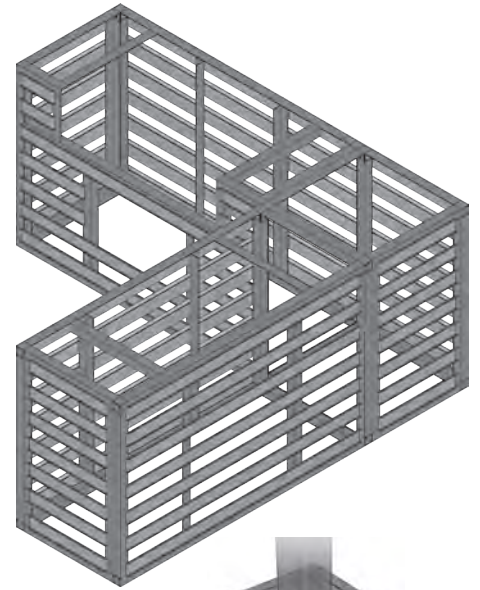

**CORNER MODULE**  
Model : U-CC 28  
27½ x 27½"  
699 x 699mm

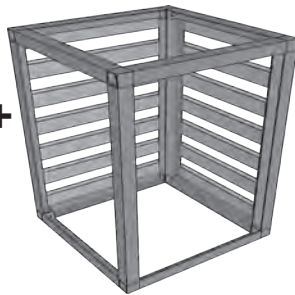

**CORNER MODULE**  
Model : U-CC 2837  
27½ x 36½"  
699 x 927mm

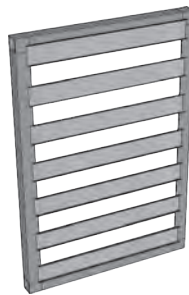

**STANDARD END CAP**  
Model : U-EC 28  
23½ x 41⅞"  
597 x 1056mm



**LARGE END CAP**  
Model : U-EC 37  
32¾ x 41⅞"  
832 x 1056mm



**PILLAR UNIT**  
Model : UL-PU  
18½ x 18½ x 41⅞"  
470 x 470 x 1056mm

### FEATURES

- | Aluminum framing
- | Pre-built panels
- | Precision fabrication
- | Lightweight
- | Expandable
- | Fits grills 36" to 42"
- | Limited lifetime warranty

### BENEFITS

- | Easy to learn
- | Build verticals in hours, not days
- | Minimal experience required
- | Moveable
- | Combines seamlessly with U-Cara SureTrack Backer Blocks

# U-CARA® WALL MOUNT SYSTEM



## EASILY CLAD STRUCTURES WITH U-CARA TO COMPLEMENT YOUR HARDSCAPE PROJECT

Ideal for garden sheds, wing walls, exposed foundation, existing steps or concrete and wood substrates.

### WITH A SIMPLE 3 STEP PROCESS:

**1** Mount Alignment Bar



**2** Attach U-Cara Mount Rails



**3** Hang U-Cara Fascia Panels

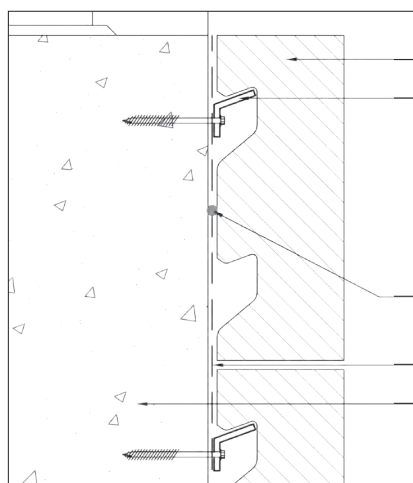

U-Cara fascia panel  
Galvanized steel U-Cara rail; one rail per panel (typical)

High-strength concrete adhesive; ¼" continuous bead (typical)

Galvanized steel U-Cara alignment bar  
Building concrete foundation/structure

*Note: Unilock is not responsible for structural strength/integrity of substrates to which the mounting system is attached.*



\*Visit [unilock.com](http://unilock.com) to download the U-CARA Modular System Brochure

WALLS | U-CARA®

RETAINING WALLS & VERTICAL FEATURES







UNILOCK® COLLECTION OF

# Steps, Treads, Coping & Caps

From classic, fullnose shapes to pitched-face edges, our steps, treads and coping offer a wide variety of choices for the finishing touch on your project.

**Pavers:** Umbriano® (French Grey) with Town Hall® (Basalt) accent

**Walls:** U-Cara® (Granite Fusion Pitched) with Opal Blend (Smooth) accent and Universal Coping (Light Grey)

# BRUSSELS FULLNOSE™

## CLASSIC



LIMESTONE



SANDSTONE



MIDNIGHT CHARCOAL

### VISUAL APPEARANCE

An antiqued block with a rounded edge used for steps, pools, pillars and more.

### FINISH

Weathered, antiqued, tumbled and smooth.

### PRODUCT SPECIFICATIONS



#### STANDARD

11½ x 5⅞ x 2¾"

300 x 150 x 70mm

### RECOMMENDED ADHESIVE & MORTAR



#### Alliance Gator Block Bond XP

- | VOC Compliant
- | Low odour- safe indoors or out
- | Fast curing- provides permanent overnight bond
- | Suitable for use in hot and cold environments
- | Non-shrinking- does not crack
- | Strong and versatile

Coverage: For 1/4" Bead (approx)

10 oz		28 oz	
m	ft.	m	ft.
-9	-31	-26	-86



#### Ardex X32 Microtec

- | Fast setting - 3 hours
- | Water repellent - for fast track swimming pool and wet area applications
- | Ideal for heavy and large format tiles
- | Easy to mix and apply - just add water
- | Ideal for pool surroundings, patios, walkways, roof decks and more
- | For joints up to 1 ¼" (32mm)
- | Ideal for Natural Stone, Porcelain, Granite
- | Two colours: Grey, White

Coverage: 1/4" x 1/4" Sq. Notch trowel; 80 sq. ft. (7.4 sq. m)

### PRODUCT DATA

Stones & Bundling	Unit	LnFt Per				Per Bundle		Soldier LnFt Per			Sailor LnFt per			Units Per			Lbs Per		
	Thickness	Bundle	Layer	Section	Stone	Layers	Sections	Unit	Section	Bundle	Unit	Section	Bundle	SqFt	Section	Bundle	Layer	Section	Bundle
<b>Ayr Manufacturing</b>																			
Standard /Non-antiqued	2¾" (70mm)	96.00	12.00	24.00	0.50	8	4	0.51	23.60	94.50	-	-	-	2.00	48	192	355	710	2,841

Notes: Non-antiqued available in full bundles only. All measurements are nominal. For more information, samples or custom options, please contact your Unilock Territory Manager or call 1-800-UNILOCK.

\*Colour selection should be chosen from actual samples.

# ENDURA™ COPING NEW FOR 2023



ENDURACOLOR™



ALMOND GROVE FUSION

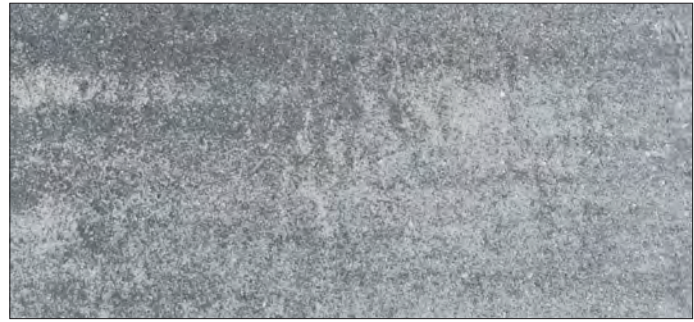

GRANITE MIST



FOSSIL



OPAL BLEND

## VISUAL APPEARANCE

Flat surface texture for a sleek, modern look with a contemporary colour palette.

## FINISH

Smooth with EnduraColor™ finish.

## PRODUCT SPECIFICATIONS



### BULLNOSE

14 x 24 x 2 3/8"  
360 x 600 x 60mm



### CHAMFERED

14 x 24 x 2 3/8"  
360 x 600 x 60mm

## RECOMMENDED ADHESIVE & MORTAR



### Alliance Gator Block Bond XP

- | VOC Compliant
- | Low odour- safe indoors or out
- | Fast curing- provides permanent overnight bond
- | Suitable for use in hot and cold environments
- | Non-shrinking- does not crack
- | Strong and versatile

Coverage: For 1/4" Bead (approx)

10 oz		28 oz	
m	ft.	m	ft.
-9	-31	-26	-86



### Ardex X32 Microtec

- | Fast setting - 3 hours
- | Water repellent - for fast track swimming pool and wet area applications
- | Ideal for heavy and large format tiles
- | Easy to mix and apply - just add water
- | Ideal for pool surroundings, patios, walkways, roof decks and more
- | For joints up to 1 1/4" (32mm)
- | Ideal for Natural Stone, Porcelain, Granite
- | Two colours: Grey, White

Coverage: 1/4" x 1/4" Sq. Notch trowel; 80 sq. ft. (7.4 sq. m)

## PRODUCT DATA

Stones & Bundling	Unit	LnFt Per			Per Bundle		Soldier LnFt Per			Sailor LnFt per			Units Per			Lbs Per		
	Thickness	Unit	Layer	Bundle	Layers	Sections	Unit	Section	Bundle	Unit	Layer	Bundle	SqFt	Section	Bundle	Layer	Section	Bundle
<b>Pickering Manufacturing</b>																		
Endura Coping	2 3/8" (60mm)	1.31	7.87	47.24	6	-	-	-	-	1.31	7.87	47.24	-	-	24	251.62	-	1,509.74

Notes: Non-antiqued available in full bundles only. All measurements are nominal. For more information, samples or custom options, please contact your Unilock Territory Manager or call 1-800-UNILOCK.



# LEDGESTONE™ PILLAR CAPS & COPING

## STONEMARK™



*\*Special Order only. Minimum qtys apply\**



BUFF



GREY

### VISUAL APPEARANCE

Look and feel of Natural Stone.

### FINISH

Smooth top with rounded edges.

### PRODUCT SPECIFICATIONS



**24" PILLAR CAP**  
24 x 24 x 3 7/8"  
610 x 610 x 90mm



**COPING UNIT**  
12 x 24 x 2 3/4"  
300 x 610 x 70mm



**CLOSED END COPING UNIT**  
12 x 24 x 2 3/4"  
300 x 610 x 70mm



**FULLNOSE COPING UNIT**  
12 x 24 x 1 3/4"  
300 x 610 x 45mm

### RECOMMENDED ADHESIVE & MORTAR



#### Alliance Gator Block Bond XP

- | VOC Compliant
- | Low odour- safe indoors or out
- | Fast curing- provides permanent overnight bond
- | Suitable for use in hot and cold environments
- | Non-shrinking- does not crack
- | Strong and versatile

Coverage: For 1/4" Bead (approx)

10 oz		28 oz	
m	ft.	m	ft.
-9	-31	-26	-86



#### Ardex X32 Microtec

- | Fast setting - 3 hours
- | Water repellent - for fast track swimming pool and wet area applications
- | Ideal for heavy and large format tiles
- | Easy to mix and apply - just add water
- | Ideal for pool surroundings, patios, walkways, roof decks and more
- | For joints up to 1 1/4" (32mm)
- | Ideal for Natural Stone, Porcelain, Granite
- | Two colours: Grey, White

Coverage: 1/4" x 1/4" Sq. Notch trowel; 80 sq. ft. (7.4 sq. m)

\*Colour selection should be chosen from actual samples.

**TECHNICAL INFORMATION**

**ASTM C 1372 Standard Specifications for Dry-Cast Segmental Retaining Wall Units**

Conforms to:

- C140 for Absorption and Compressive Strength > 3000 PSI
- C1262 for Freeze Thaw Durability <1% mass loss
- C1372 Overall dimensional variations permissible for width, height and length +/- 1/8" (+/-3.2mm)

**Unilock standards exceed 8,000 PSI for Ledgestone™ products with:**

- 4% absorption avg.
  - 5% absorption max.
  - Dimensional Accuracy +/- 5/64" (+/-2.00mm)
- Test results available upon request*

**LEED INFORMATION**

**Materials & Resources: LEED V4:**

- Building Product Disclosure and Optimization
- Sourcing of Raw Materials - Sourcing of Raw Materials and Extraction • **1 point**
- Sourcing of Raw Materials - Leadership Extraction Practices • **1 point**
- Material Ingredient Reporting - Material Ingredient Reporting • **1 point**
- Material Ingredient Reporting - Material Ingredient Optimization • **1 point**
- Environmental Product Declaration • **1 point**

**PRODUCT DATA**

Stones & Bundling	Face Feet Per		Linear Feet Per		Units Per		Per Bundle		Lbs Per	
	Bundle	Unit	Bundle	Unit	Bundle	Face Feet	Layers	Sections	Unit	Bundle
<b>Coping &amp; 24 x 24 Pillar Cap - Chicago Manufacturing, stocked in Ayr; Steps &amp; 29 x 29 Pillar Cap - Georgetown</b>										
Pillar Cap - 24" x 24"	-	-	-	-	5	-	-	-	159	795
Pillar Cap - 29" x 29"	-	-	-	-	5	-	-	-	302	1,510
Coping Closed-End 24"	-	-	24.00	2.00	12	-	-	-	66	796
Coping 24"	-	-	24.00	2.00	12	-	-	-	64	772
Fullnose Coping	-	-	26.00	2.00	13	-	-	-	42	667

Notes: **Ledgestone Coping and 24" x 24" Pillar Caps are sold on a non-refundable skid.** When applying adhesive to a pillar cap or coping unit, scoring the underside of the unit may increase the bond. All sales of this product are final and non-refundable. All measurements are nominal. For more information, samples or custom options, please contact your Unilock Territory Manager or call 1-800-UNILOCK.

# PISA COPING

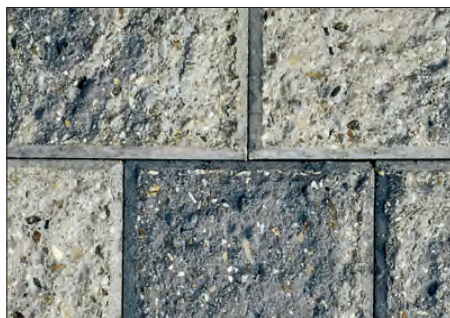

GRANITE



MAHOGANY



NATURAL



SIERRA

## VISUAL APPEARANCE

Split / Rock Faced to complement the Pisa™ Wall.

## FINISH

Split / Rock Faced.

## PRODUCT SPECIFICATIONS



### 24" COPING

12 x 24 x 3"  
300 x 610 x 75mm

## RECOMMENDED ADHESIVE & MORTAR



### Alliance Gator Block Bond XP

- | VOC Compliant
- | Low odour- safe indoors or out
- | Fast curing- provides permanent overnight bond
- | Suitable for use in hot and cold environments
- | Non-shrinking- does not crack
- | Strong and versatile

Coverage: For 1/4" Bead (approx)

10 oz		28 oz	
m	ft.	m	ft.
-9	-31	-26	-86



### Ardex X32 Microtec

- | Fast setting - 3 hours
- | Water repellent - for fast track swimming pool and wet area applications
- | Ideal for heavy and large format tiles
- | Easy to mix and apply - just add water
- | Ideal for pool surroundings, patios, walkways, roof decks and more
- | For joints up to 1 1/4" (32mm)
- | Ideal for Natural Stone, Porcelain, Granite
- | Two colours: Grey, White

Coverage: 1/4" x 1/4" Sq. Notch trowel; 80 sq. ft. (7.4 sq. m)

## PRODUCT DATA

Stones & Bundling	Face Feet Per		Linear Feet Per		Units Per		Per Bundle		Lbs Per	
	Bundle	Unit	Bundle	Unit	Bundle	Face Feet	Layers	Sections	Unit	Bundle
<b>Gormley Manufacturing</b>										
Coping 24" - Double Unit (does not include closed end units)	16.00	1.00	64.00	4.00	16	1.00	-	2	145	2,320

Notes: Sold in full bundles or sections only. All measurements are nominal. For more information, samples or custom options, please contact your Unilock Territory Manager or call 1-800-UNILOCK.

\*Colour selection should be chosen from actual samples.

# PISA SMOOTH™ COPING

## CLASSIC



CLIFFSIDE GREY



GRANITE BLEND



IRISH COAST

### VISUAL APPEARANCE

A sleek, linear aesthetic with clean lines and subtle edge details that blend well with both modern and traditional design.

### FINISH

Smooth, linear appearance.

### PRODUCT SPECIFICATIONS



#### COPING

13<sup>7</sup>/<sub>8</sub> x 21<sup>3</sup>/<sub>4</sub> x 3<sup>3</sup>/<sub>8</sub>"  
350 x 550 x 85mm

### RECOMMENDED ADHESIVE & MORTAR



#### Alliance Gator Block Bond XP

- | VOC Compliant
- | Low odour- safe indoors or out
- | Fast curing- provides permanent overnight bond
- | Suitable for use in hot and cold environments
- | Non-shrinking- does not crack
- | Strong and versatile

Coverage: For 1/4" Bead (approx)

10 oz		28 oz	
m	ft.	m	ft.
-9	-31	-26	-86



#### Ardex X32 Microtec

- | Fast setting - 3 hours
- | Water repellent - for fast track swimming pool and wet area applications
- | Ideal for heavy and large format tiles
- | Easy to mix and apply - just add water
- | Ideal for pool surroundings, patios, walkways, roof decks and more
- | For joints up to 1 1/4" (32mm)
- | Ideal for Natural Stone, Porcelain, Granite
- | Two colours: Grey, White

Coverage: 1/4" x 1/4" Sq. Notch trowel; 80 sq. ft. (7.4 sq. m)

### PRODUCT DATA

Stones & Bundling	Face Feet Per		Linear Feet Per		Units Per		Per Bundle	Lbs Per	
	Bundle	Unit	Bundle	Unit	Bundle	Layer	Layers	Unit	Bundle
<b>Gormley Manufacturing</b>									
Coping Unit	18.12	0.50	64.96	1.805	36	6	6	76.74	2,763

Notes: Sold in full bundles or sections only. For more information, samples or custom options, please contact your Unilock Territory Manager or call 1-800-UNILOCK.

\*Colour selection should be chosen from actual samples.

PISA™ COPING / PISA SMOOTH™ COPING

STEPS, TREADS, COPING & CAPS

# UMBRIANO® COPING

ENDURACOLOR™



FRENCH GREY



GRENADA WHITE

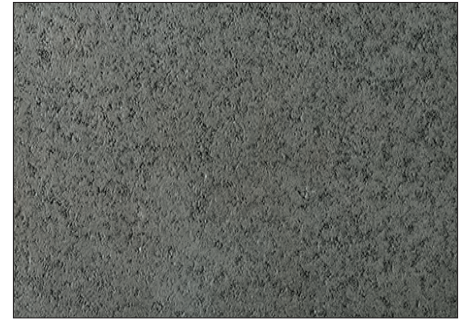

MIDNIGHT SKY



SUMMER WHEAT



WINTER MARVEL

## VISUAL APPEARANCE

Granite-like surface appearance.

## FINISH

Mottled surface with ColorFusion™ Technology which randomly disperses rich colour and granite particles to achieve a natural, non-slip texture. Factory sealed with EasyClean™, an integral surface protection from stains.

## PRODUCT SPECIFICATIONS



### CHAMFERED

14 x 24 x 2 3/8"  
360 x 600 x 60mm



### BULLNOSE

14 x 24 x 2 3/8"  
360 x 600 x 60mm

## RECOMMENDED ADHESIVE & MORTAR



### Alliance Gator Block Bond XP

- | VOC Compliant
- | Low odour- safe indoors or out
- | Fast curing- provides permanent overnight bond
- | Suitable for use in hot and cold environments
- | Non-shrinking- does not crack
- | Strong and versatile

Coverage: For 1/4" Bead (approx)

10 oz		28 oz	
m	ft.	m	ft.
-9	-31	-26	-86



### Ardex X32 Microtec

- | Fast setting - 3 hours
- | Water repellent - for fast track swimming pool and wet area applications
- | Ideal for heavy and large format tiles
- | Easy to mix and apply - just add water
- | Ideal for pool surroundings, patios, walkways, roof decks and more
- | For joints up to 1 1/4" (32mm)
- | Ideal for Natural Stone, Porcelain, Granite
- | Two colours: Grey, White

Coverage: 1/4" x 1/4" Sq. Notch trowel; 80 sq. ft. (7.4 sq. m)

## PRODUCT DATA

Stones & Bundling	Face Feet Per		Linear Feet Per		Units Per		Per Bundle		Lbs Per	
	Bundle	Unit	Bundle	Unit	Bundle	Layer	Layers	Sections	Unit	Bundle
<b>Georgetown Manufacturing</b>										
Umbriano Coping	9.30	0.39	47.24	1.97	24	4	6	-	62.91	1,510

Notes: Sold in full bundles only. For more information, samples or custom options, please contact your Unilock Territory Manager or call 1-800-UNILOCK.

\*Colour selection should be chosen from actual samples.





# UNIVERSAL COPING

ENDURACOLOR™



LIGHT GREY

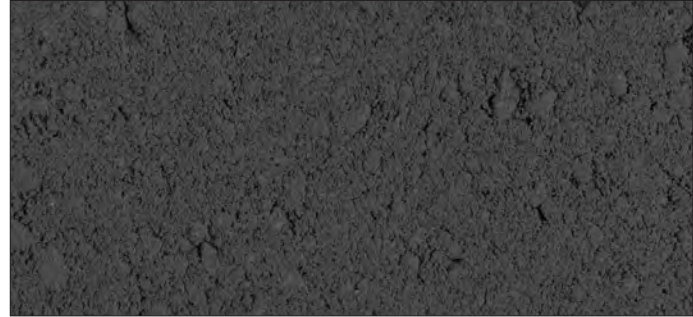

MIDNIGHT CHARCOAL



TAN

## VISUAL APPEARANCE

Versatile to suit many applications, from traditional to modern.

## FINISH

Smooth.

## PRODUCT SPECIFICATIONS



14 x 19 x 2 3/4"  
360 x 480 x 70mm

## RECOMMENDED ADHESIVE & MORTAR



### Alliance Gator Block Bond XP

- | VOC Compliant
- | Low odour- safe indoors or out
- | Fast curing- provides permanent overnight bond
- | Suitable for use in hot and cold environments
- | Non-shrinking- does not crack
- | Strong and versatile

Coverage: For 1/4" Bead (approx)

10 oz		28 oz	
m	ft.	m	ft.
-9	-31	-26	-86



### ArDEX X32 Microtec

- | Fast setting - 3 hours
- | Water repellent - for fast track swimming pool and wet area applications
- | Ideal for heavy and large format tiles
- | Easy to mix and apply - just add water
- | Ideal for pool surroundings, patios, walkways, roof decks and more
- | For joints up to 1 1/4" (32mm)
- | Ideal for Natural Stone, Porcelain, Granite
- | Two colours: Grey, White

Coverage: 1/4" x 1/4" Sq. Notch trowel; 80 sq. ft. (7.4 sq. m)

## PRODUCT DATA

Stones & Bundling	Face Feet Per		Linear Feet Per		Units Per		Per Bundle		Lbs Per	
	Bundle	Unit	Bundle	Unit	Bundle	Face Feet	Layers	Sections	Unit	Bundle
<b>Pickering Manufacturing</b>										
Universal Coping	17.44	0.36	75.90	1.58	48	-	8	-	57	2,747

Notes: Sold in full bundles only. For more information, samples or custom options, please contact your Unilock Territory Manager or call 1-800-UNILOCK.

\*Colour selection should be chosen from actual samples.

# URBAN LINE COPING

NEW FOR 2023



ENDURACOLOR™



INDIANA BUFF **NEW**



STERLING **NEW**

## VISUAL APPEARANCE

Modern and contemporary coping option to complement any modern wall, including U-Cara panel options, creating a trendsetting, monochromatic design.

## FINISH

Smooth EnduraColor finish - subtly mottled colour and finish.

## PRODUCT SPECIFICATIONS



### BULLNOSE

19 x 36 x 2<sup>3</sup>/<sub>8</sub>"

485 x 900 x 60mm



### CHAMFERED

19 x 36 x 2<sup>3</sup>/<sub>8</sub>"

485 x 900 x 60mm

## RECOMMENDED ADHESIVE & MORTAR



### Alliance Gator Block Bond XP

- | VOC Compliant
- | Low odour- safe indoors or out
- | Fast curing- provides permanent overnight bond
- | Suitable for use in hot and cold environments
- | Non-shrinking- does not crack
- | Strong and versatile

Coverage: For 1/4" Bead (approx)

10 oz		28 oz	
m	ft.	m	ft.
-9	-31	-26	-86



### ArDEX X32 Microtec

- | Fast setting - 3 hours
- | Water repellent - for fast track swimming pool and wet area applications
- | Ideal for heavy and large format tiles
- | Easy to mix and apply - just add water
- | Ideal for pool surroundings, patios, walkways, roof decks and more
- | For joints up to 1 1/4" (32mm)
- | Ideal for Natural Stone, Porcelain, Granite
- | Two colours: Grey, White

Coverage: 1/4" x 1/4" Sq. Notch trowel; 80 sq. ft. (7.4 sq. m)

## PRODUCT DATA

	Face Feet Per		Linear Feet Per		Units Per		Per Bundle		Lbs Per	
	Bundle	Unit	Bundle	Unit	Bundle	Face Feet	Layers	Sections	Unit	Bundle
Pickering Manufacturing										
Urban Line Coping	52.314		35.5		12	-	6	-	119.65	1,435.76

Notes: Sold in full bundles only. For more information, samples or custom options, please contact your Unilock Territory Manager or call 1-800-UNILOCK.

\*Colour selection should be chosen from actual samples.

# NATURAL STONE COPING

BLACK RIVER - LIMESTONE

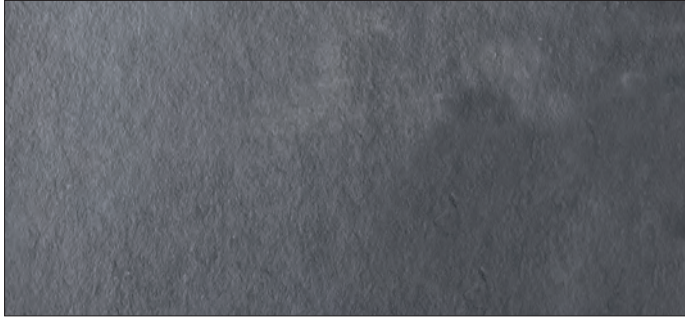

BLACK RIVER - LIMESTONE Available in Rock Face only

## VISUAL APPEARANCE

Unique and rich. Every stone has its own colour and texture variation, ensuring a one-of-a-kind look for your project.

## FINISH

Riven surface, calibrated. All sides sawn.

## PRODUCT SPECIFICATIONS



**4' LENGTH**  
14 x 48 x 2"  
350 x 1200 x 50mm



**6' LENGTH**  
14 x 72 x 2"  
350 x 1800 x 50mm

### RECOMMENDED ADHESIVE & MORTAR



#### Alliance Gator Block Bond XP

- | VOC Compliant
- | Low odour- safe indoors or out
- | Fast curing- provides permanent overnight bond
- | Suitable for use in hot and cold environments
- | Non-shrinking- does not crack
- | Strong and versatile

Coverage: For 1/4" Bead (approx)

10 oz		28 oz	
m	ft.	m	ft.
-9	-31	-26	-86



#### Ardex X32 Microtec

- | Fast setting - 3 hours
- | Water repellent - for fast track swimming pool and wet area applications
- | Ideal for heavy and large format tiles
- | Easy to mix and apply - just add water
- | Ideal for pool surroundings, patios, walkways, roof decks and more
- | For joints up to 1 1/4" (32mm)
- | Ideal for Natural Stone, Porcelain, Granite
- | Two colours: Grey, White

Coverage: 1/4" x 1/4" Sq. Notch trowel; 80 sq. ft. (7.4 sq. m)

## Natural Edge Coping

Stones & Bundling	Unit Thickness	SqFt/ Crate	Linear Ft/ Crate	Linear Ft/ Unit	Units/ Crate	Lbs/ Unit	Lbs/ Crate
14" x 48" (360 x 1200mm)	2" (50mm)	84	72	4	18	121	2,178
14" x 72" (360 x 1830mm)	2" (50mm)	84	72	6	12	181	2,169

For more information, samples or custom options, please contact your Unilock Territory Manager or call 1-800-UNILOCK.

\*All Natural Stone is being stocked at our Barrie location.



[commercial.unilock.com/download/documents/technical-guides/](http://commercial.unilock.com/download/documents/technical-guides/)

\*Colour selection should be chosen from actual samples.

URBAN LINE COPING / NATURAL STONE PILLAR CAPS & COPING

STEPS, TREADS, COPING & CAPS

# NATURAL STONE COPING

GREYFIELD / INDIAN COAST / IVORY SAND / STONECLIFF GREY - SANDSTONE

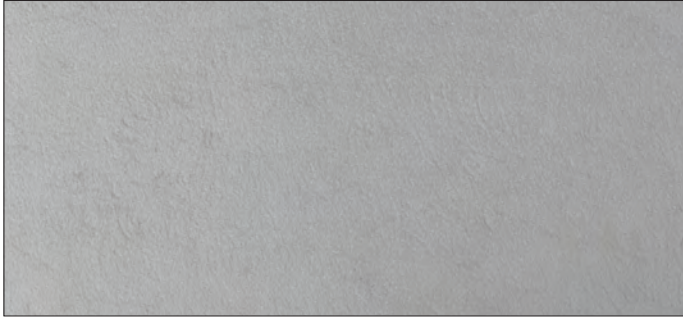

GREYFIELD Available in Rock Face and Smooth



INDIAN COAST Available in Rock Face and Smooth



IVORY SAND **NEW** Available in Rock Face and Smooth



STONECLIFF GREY Available in Rock Face only

## VISUAL APPEARANCE

Unique and rich. Every stone has its own colour and texture variation, ensuring a one-of-a-kind look for your project.

## FINISH

Riven surface, calibrated. All sides sawn.

## PRODUCT SPECIFICATIONS



**4' LENGTH**  
14 x 48 x 2"  
350 x 1200 x 50mm



**6' LENGTH**  
14 x 72 x 2"  
350 x 1800 x 50mm

## RECOMMENDED ADHESIVE & MORTAR



### Alliance Gator Block Bond XP

- | VOC Compliant
- | Low odour- safe indoors or out
- | Fast curing- provides permanent overnight bond
- | Suitable for use in hot and cold environments
- | Non-shrinking- does not crack
- | Strong and versatile

Coverage: For 1/4" Bead (approx)

10 oz		28 oz	
m	ft.	m	ft.
-9	-31	-26	-86



### ArDEX X32 Microtec

- | Fast setting - 3 hours
- | Water repellent - for fast track swimming pool and wet area applications
- | Ideal for heavy and large format tiles
- | Easy to mix and apply - just add water
- | Ideal for pool surroundings, patios, walkways, roof decks and more
- | For joints up to 1 1/4" (32mm)
- | Ideal for Natural Stone, Porcelain, Granite
- | Two colours: Grey, White

Coverage: 1/4" x 1/4" Sq. Notch trowel; 80 sq. ft. (7.4 sq. m)

## Natural Edge Coping (Smooth or Rock Face)

Stones & Bundling	Unit Thickness	SqFt/ Crate	Linear Ft/ Crate	Linear Ft/ Unit	Units/ Crate	Lbs/ Unit	Lbs/ Crate
14" x 48" (360 x 1200mm)	2" (50mm)	84	72	4	18	121	2,178
14" x 72" (360 x 1830mm)	2" (50mm)	84	72	6	12	181	2,169

For more information, samples or custom options, please contact your Unilock Territory Manager or call 1-800-UNILOCK.

\*Colour selection should be chosen from actual samples.

# NATURAL STONE PILLAR CAPS & COPING

TUSCAN BUCINE BLUESTONE - SANDSTONE

AVAILABLE WHILE QUANTITIES LAST



TUSCAN BUCINE BLUESTONE - SANDSTONE

Stone Type	Fine Grained Sedimentary Sandstone
Visual Appearance	Uniform Grey colour sandstone, flamed finish
Origin	Tuscany, Italy
Generic Stone Name	Pietra Extra Dura del Bucine
Age	From ancient populations, through Renaissance
Finish	<i>PILLAR CAP:</i> Flamed Surface, All 4 Edges Flamed <i>COPING:</i> Flamed Surface, 1 Long Edge Flamed & 3 Sawn Edges

## PRODUCT SPECIFICATIONS



**PILLAR CAP**  
24 x 24 x 2"  
600 x 600 x 50mm



**COPING**  
14 x 48 x 2"  
350 x 1200 x 50mm

## RECOMMENDED ADHESIVE & MORTAR



**Alliance Gator Block Bond XP**

- | VOC Compliant
- | Low odour- safe indoors or out
- | Fast curing- provides permanent overnight bond
- | Suitable for use in hot and cold environments
- | Non-shrinking- does not crack
- | Strong and versatile

Coverage: For 1/4" Bead (approx)

10 oz		28 oz	
m	ft.	m	ft.
-9	-31	-26	-86



**Ardex X32 Microtec**

- | Fast setting - 3 hours
- | Water repellent - for fast track swimming pool and wet area applications
- | Ideal for heavy and large format tiles
- | Easy to mix and apply - just add water
- | Ideal for pool surroundings, patios, walkways, roof decks and more
- | For joints up to 1 1/4" (32mm)
- | Ideal for Natural Stone, Porcelain, Granite
- | Two colours: Grey, White

Coverage: 1/4" x 1/4" Sq. Notch trowel; 80 sq. ft. (7.4 sq. m)

NATURAL STONE PILLAR CAPS COPING

STEPS, TREADS,  
COPING & CAPS

\*Colour selection should be chosen from actual samples.

## LEED TESTING DETAILS

Testing Details	Mean
Water Absorbancy	1.09%
Apparent Density	2660 Kg/m <sup>3</sup>
Compressive Strength	133 Mpa
Modulus of Rupture	19,5 Mpa (17.3%)
Slip Resistance (When Wet)	69 SRV

## SOLAR REFLECTIVE INDEX (SRI) TESTING DETAILS

Product	Solar Reflectance	SRI	Thermal Emittance
Bucine Bluestone	0.35	36 	0.87

## PRODUCT DATA

Stones & Bundling	Unit Thickness	SqFt/ Crate	SqFt/ Stone	Lin.Ft/ Unit	Units/ Crate	Lbs/ Unit	Lbs/ Crate
Pillar Cap 24" x 24" x 2" (600 x 600mm)	2" (50mm)	56.08	4	2	14	111.49	1,560.87
Coping 14" x 48" x 2" (360 x 1200)	2" (50mm)	121.33	4.80	4	26	130.07	3,381.89

For more information, samples or custom options, please contact your Unilock Territory Manager or call 1-800-UNILOCK.

*\*All Natural Stone is being stocked at our Barrie location.*



\*Contact your Unilock Territory Manager for installation best practices or visit [commercial.unilock.com](http://commercial.unilock.com) and refer to Natural Stone- Installation Guidelines.

[commercial.unilock.com/download/documents/technical-guides/](http://commercial.unilock.com/download/documents/technical-guides/)

# LEDGESTONE™ STEPS

## STONEMARK™



BUFF

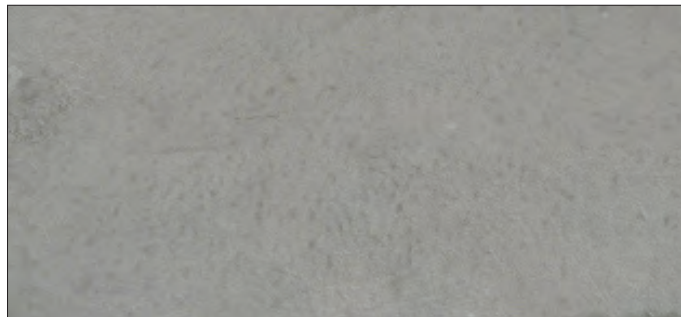

GREY

### VISUAL APPEARANCE

Look and feel of Natural Stone.

### FINISH

Smooth top with Rock Face edges.

### PRODUCT SPECIFICATIONS



#### 48" STEP

24 x 48 x 6"

600 x 1200 x 150mm

### TECHNICAL INFORMATION

#### ASTM C 1372 Standard Specifications for Dry-Cast Segmental Retaining Wall Units

Conforms to:

- C140 for Absorption and Compressive Strength > 3000 PSI
- C1262 for Freeze Thaw Durability <1% mass loss
- C1372 Overall dimensional variations permissible for width, height and length +/- 1/8" (+/-3.2mm)

#### Unilock standards exceed 8,000 PSI for Ledgestone products with:

- 4% absorption avg.
- 5% absorption max.
- Dimensional Accuracy +/- 5/64" (+/-2.00mm)

*Test results available upon request*

### LEED INFORMATION

#### Materials & Resources: LEED V4:

- Building Product Disclosure and Optimization
- Sourcing of Raw Materials - Sourcing of Raw Materials and Extraction • **1 point**
- Sourcing of Raw Materials - Leadership Extraction Practices • **1 point**
- Material Ingredient Reporting - Material Ingredient Reporting • **1 point**
- Material Ingredient Reporting - Material Ingredient Optimization • **1 point**
- Environmental Product Declaration • **1 point**

### PRODUCT DATA

Stones & Bundling	Face Feet Per		Linear Feet Per		Units Per		Per Bundle		Lbs Per	
	Bundle	Unit	Bundle	Unit	Bundle	Face Feet	Layers	Sections	Unit	Bundle
<b>Coping &amp; 24 x 24 Pillar Cap - Georgetown Manufacturing</b>										
Step - 24" x 48" (600 x 1200mm)	-	-	12.00	4.00	3	-	-	-	574	1,721

Notes: **Ledgestone Steps are sold in full bundles and on a refundable skid.** All sales of this product are final and non-refundable. All measurements are nominal. For more information, samples or custom options, please contact your Unilock Territory Manager or call 1-800-UNILOCK.

\*Colour selection should be chosen from actual samples.

# SIENASTONE™ STEPS



GRANITE



MAHOGANY ASH



NATURAL

## VISUAL APPEARANCE

Bold and dramatic. An attractive solution for most heavy duty step applications.

## FINISH

Split and weathered.

## PRODUCT SPECIFICATIONS



### STEP

20 x 47¼ x 7¼"

500 x 1200 x 185mm

## PRODUCT DATA

Stones & Bundling	Face Feet Per		Linear Feet Per		Units Per		Per Bundle		Lbs Per	
	Bundle	Unit	Bundle	Unit	Bundle	Face Feet	Layers	Sections	Unit	Bundle
<b>Gormley Manufacturing</b>										
Step 48" (500 x 1200mm)	14.28	2.38	24.00	4.00	6	0.43	-	-	570	3,420

Notes: 48" step 2 edge details on the same unit (Chamfer and Rounded). Engineering services are available. For more information, samples or custom options, please contact your Unilock Territory Manager or call 1-800-UNILOCK.

\*Colour selection should be chosen from actual samples.



# SIENASTONE™ SMOOTH STEPS



**CLIFFSIDE GREY** **NEW**  
Only available in 48" Step



**DUSK** **NEW**

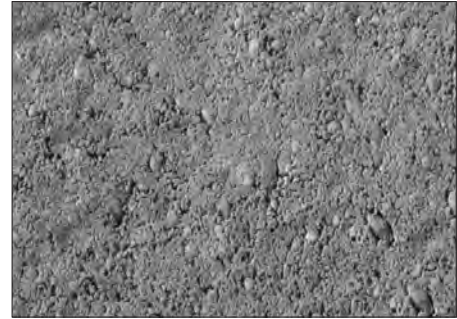

**GRANITE BLEND**



**IRISH COAST** **NEW**  
Only available in 48" Step

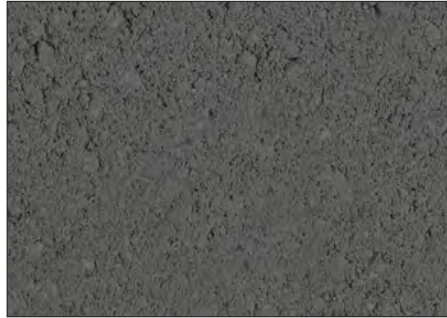

**MIDNIGHT CHARCOAL**



**SAFARI** **NEW**

## VISUAL APPEARANCE

Bold and dramatic. An attractive solution for most heavy duty step applications.

## FINISH

Smooth.

## PRODUCT SPECIFICATIONS



**48" STEP**  
20 x 47¼ x 7"  
500 x 1200 x 180mm



**72" STEP**  
20 x 70¾ x 7"  
500 x 1800 x 180mm  
*Not available in Cliffside Grey or Irish Coast*

2 Edge details available on the same unit (Chamfer and Rounded).

Contact your Unilock Territory Manager or call 1-800-UNILOCK for more information.

## PRODUCT DATA

Stones & Bundling	Face Feet Per		Linear Feet Per		Units Per		Per Bundle		Lbs Per	
	Bundle	Unit	Bundle	Unit	Bundle	Face Feet	Layers	Sections	Unit	Bundle
<b>Gormley Manufacturing</b>										
Step 48" (500 x 1200mm)	13.95	2.33	24.00	4.00	6	0.43	-	-	570	3,420
Step 72" (500 x 1800mm)	6.97	3.48	11.81	5.91	2	0.29	-	-	798	1,596

Notes: 48" and 72" step 2 edge details on the same unit (Chamfer and Rounded). Engineering services are available. For more information, samples or custom options, please contact your Unilock Territory Manager or call 1-800-UNILOCK.

\*Colour selection should be chosen from actual samples.

LEDGESTONE™ STEPS / SIENASTONE™ SMOOTH STEPS

**STEPS, TREADS,  
COPING & CAPS**

# NATURAL STONE STEPS

BLACK RIVER - LIMESTONE



BLACK RIVER - LIMESTONE

*Steps are available in Rock Face only.*

## VISUAL APPEARANCE

Unique and rich. Every stone has its own colour and texture variation, ensuring a one-of-a-kind look for your project.

## FINISH

Riven surface, calibrated. All sides sawn.

## PRODUCT SPECIFICATIONS

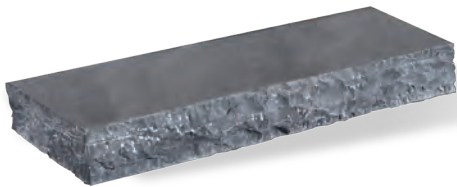

### 4' LENGTH

16 x 47 $\frac{1}{4}$  x 6"  
400 x 1200 x 150mm



### 6' LENGTH

16 x 70 $\frac{3}{4}$  x 6"  
400 x 1800 x 150mm

## Steps

Stones & Bundling	Unit Thickness	SqFt/ Crate	Linear Ft/ Crate	Linear Ft/ Unit	Units/ Crate	Lbs/ Unit	Lbs/ Crate
16" x 48" (400 x 1200mm)	6" (150mm)	32	24	4	6	421.08	2,526
16" x 72" (400 x 1800mm)	6" (150mm)	32	24	6	4	628.31	2,513

For more information, samples or custom options, please contact your Unilock Territory Manager or call 1-800-UNILOCK.

*\*All Natural Stone is being stocked at our Barrie location.*

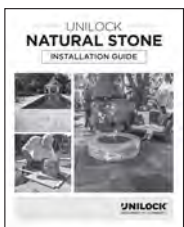

\*Contact your Unilock Territory Manager for installation best practices or visit [commercial.unilock.com](http://commercial.unilock.com) and refer to Natural Stone- Installation Guidelines.

[commercial.unilock.com/download/documents/technical-guides/](http://commercial.unilock.com/download/documents/technical-guides/)

\*Colour selection should be chosen from actual samples.

# NATURAL STONE STEPS

GREYFIELD / INDIAN COAST / IVORY SAND / STONECLIFF GREY - SANDSTONE



GREYFIELD Available in Rock Face and Smooth



INDIAN COAST Available in Rock Face and Smooth

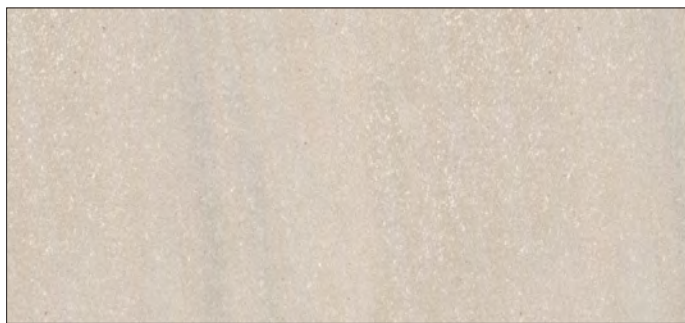

IVORY SAND **NEW** Available in Rock Face and Smooth



STONECLIFF GREY Available in Rock Face only

## VISUAL APPEARANCE

Unique and rich. Every stone has it's own colour and texture variation, ensuring a one-of-a-kind look for your project.

## FINISH

Riven surface, calibrated. All sides sawn.

## PRODUCT SPECIFICATIONS



**4' LENGTH**  
16 x 47¼ x 6"  
400 x 1200 x 150mm



**6' LENGTH**  
16 x 70¾ x 6"  
400 x 1800 x 150mm

## Steps

Stones & Bundling	Unit Thickness	SqFt/ Crate	Linear Ft/ Crate	Linear Ft/ Unit	Units/ Crate	Lbs/ Unit	Lbs/ Crate
16" x 48" (400 x 1200mm)	6" (150mm)	32	24	4	6	421.08	2,526
16" x 72" (400 x 1800mm)	6" (150mm)	32	24	6	4	628.31	2,513

For more information, samples or custom options, please contact your Unilock Territory Manager or call 1-800-UNILOCK.



*\*All Natural Stone is being stocked at our Barrie location.*

\*Contact your Unilock Territory Manager for installation best practices or visit [commercial.unilock.com](http://commercial.unilock.com) and refer to Natural Stone- Installation Guidelines.

[commercial.unilock.com/download/documents/technical-guides/](http://commercial.unilock.com/download/documents/technical-guides/)

\*Colour selection should be chosen from actual samples.

# NATURAL STONE STEPS

BUCINE  
BLUESTONE®  
from Tuscany



TUSCAN BUCINE BLUESTONE - SANDSTONE

*AVAILABLE WHILE QUANTITIES LAST*



TUSCAN BUCINE BLUESTONE - SANDSTONE

Stone Type	Fine Grained Sedimentary Sandstone
Visual Appearance	Uniform Grey colour sandstone, flamed finish
Origin	Tuscany, Italy
Generic Stone Name	Pietra Extra Dura del Bucine
Age	From ancient populations, through Renaissance
Finish	<i>STEPS</i> : Flamed Surface, 1 Long Edge Flamed & 3 Sawn Edges

## PRODUCT SPECIFICATIONS



### STEPS

24 x 48 x 6"

600 x 1200 x 150mm

## LEED TESTING DETAILS

Testing Details	Mean
Water Absorbancy	1.09%
Apparent Density	2660 Kg/m <sup>3</sup>
Compressive Strength	133 Mpa
Modulus of Rupture	19.5 Mpa (17.3%)
Slip Resistance (When Wet)	69 SRV

\*Colour selection should be chosen from actual samples.

SOLAR REFLECTIVE INDEX (SRI) TESTING DETAILS

Product	Solar Reflectance	SRI	Thermal Emittance
Bucine Bluestone	0.35	36 	0.87

PRODUCT DATA

Stones & Bundling	Unit Thickness	SqFt/ Crate	SqFt/ Stone	Lin.Ft/ Unit	Units/ Crate	Lbs/ Unit	Lbs/ Crate
Steps 24" x 48" x 6" (600 x 1200mm)	6" (150mm)	32	8	4	4	189.60	7,584

For more information, samples or custom options, please contact your Unilock Territory Manager or call 1-800-UNILOCK.

*\*All Natural Stone is being stocked at our Barrie location.*



\*Contact your Unilock Territory Manager for installation best practices or visit [commercial.unilock.com](http://commercial.unilock.com) and refer to Natural Stone- Installation Guidelines.

[commercial.unilock.com/download/documents/technical-guides/](http://commercial.unilock.com/download/documents/technical-guides/)





UNILOCK® COLLECTION OF

# Hardscape Accessories

HARDSCAPE  
ACCESSORIES

# SUNSET FIRE PIT

Square and Round Fire Pits are available in Brussels Dimensional Stone® colours: Sandstone and Mahogany Ash.



Square  
(shown in Mahogany Ash)



Round  
(shown in Mahogany Ash)

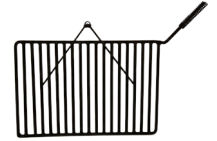
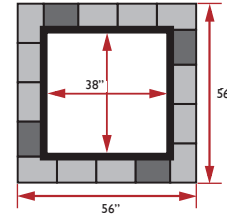

**FIRE PIT GRILL**  
Fire Pit Insert and Grill are included with the Sunset Fire Pit. This Grill fits securely into the Square Fire Pit. The swiveling Grill surface is 14" x 18".



COFFEE CREEK MAHOGANY ASH



SANDSTONE

*Reduced Smoke Insert only available for Round Sunset Fire Pit*

**UNILOCK REDUCED SMOKE INSERT**  
AVAILABLE FOR ROUND SUNSET FIRE PIT

*Reduced Smoke Insert to be purchased separately.*

**ZENTRO TECHNOLOGY FIRE PIT INSERT**

Stones & Bundling	Stones per Course	Stones per Pallet	Diameter Outside of Stone	Diameter Inside of Stone	Diameter Pit Insert	Lbs/Pallet	Kits/Bundle
Sunset - Ayr Manufacturing/Rivercrest - Georgetown Manufacturing							
Sunset/Brussels Dimensional Stone							
Square Fire Pit	16	48	56"	40"	38"	1545	1
Round Fire Pit	18	54	54"	36"	-	1512	1

# UNILOCK ELEMENTS



**MODA**  
**SPECIAL ORDER**  
Lineo, Series - Granite, Black Granite

**WOOD BURNING ONLY**

The Moda pre-built fireplace is constructed from Lineo Dimensional Stone and Series accent.



## Typical Cross Section for Concrete Pad Installation

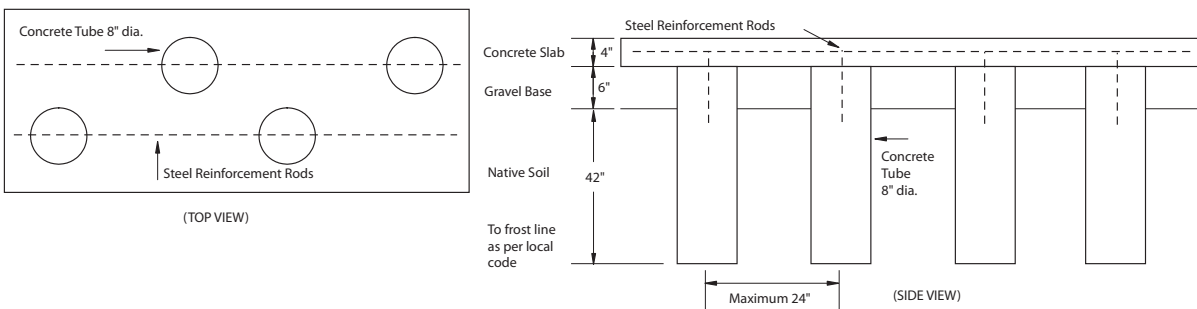

\*Colour selection should be chosen from actual samples.



# UNILOCK ELEMENTS



**TUSCANY**  
**SPECIAL ORDER**

Brussels Dimensional,  
Cophthorne - Sandstone,  
with Cophthorne 3 color  
blend accent

**WOOD BURNING ONLY**

The Tuscany pre-built fireplace is constructed from Brussels Dimensional Stone and Cophthorne accents.



Tuscany Fireplace

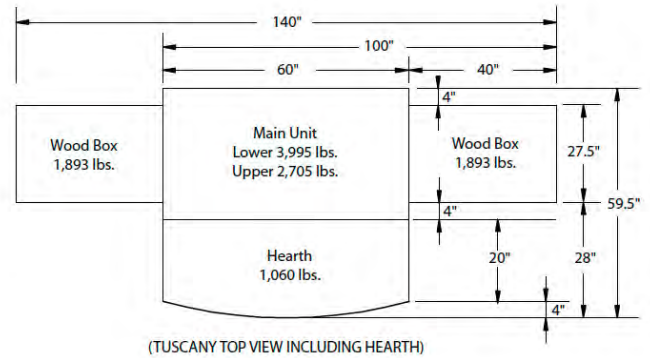
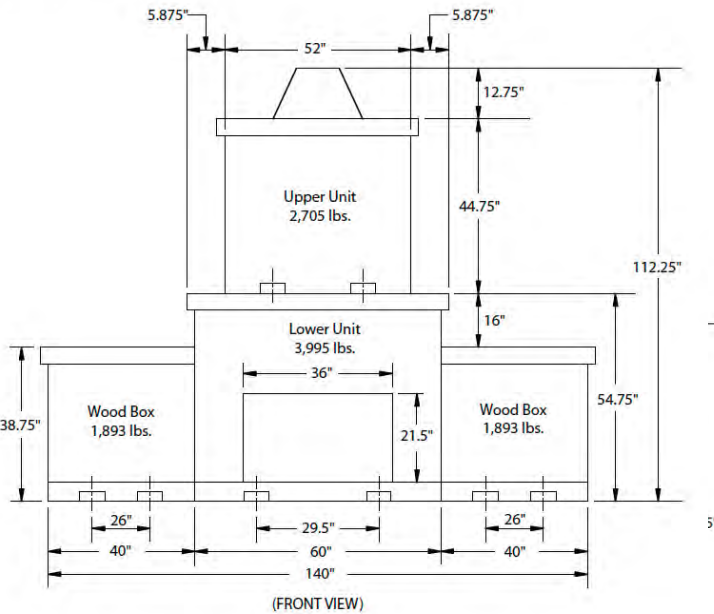

Tuscany Grill Island

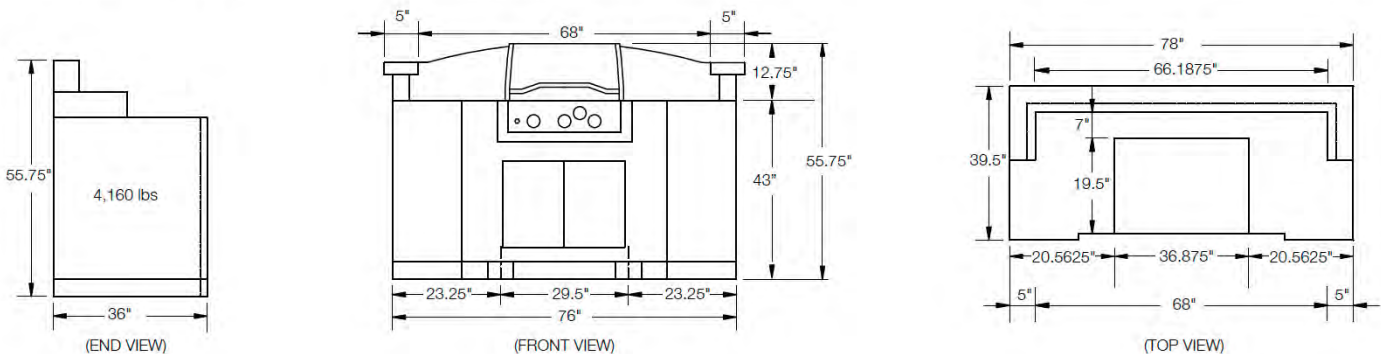

**Guarantee:** The standard Unilock guarantee applies to the units used to construct Unilock Elements. (See Unilock literature for details.) Third party grills and fireboxes carry their respective manufacturer's warranty and may change without notice.

**Note:** Unilock reserves the right to change model designs, accessories and colours without notice. Unilock will not be responsible for improper use or handling that results in property damage. Some models may not be exactly as shown. Fireplaces come complete with UL-approved stainless steel fireboxes. Check local building codes and regulations prior to ordering and installing Unilock Elements.

\*Colour selection should be chosen from actual samples.



HARDSCAPE ACCESSORIES | FIRE FEATURES

HARDSCAPE ACCESSORIES

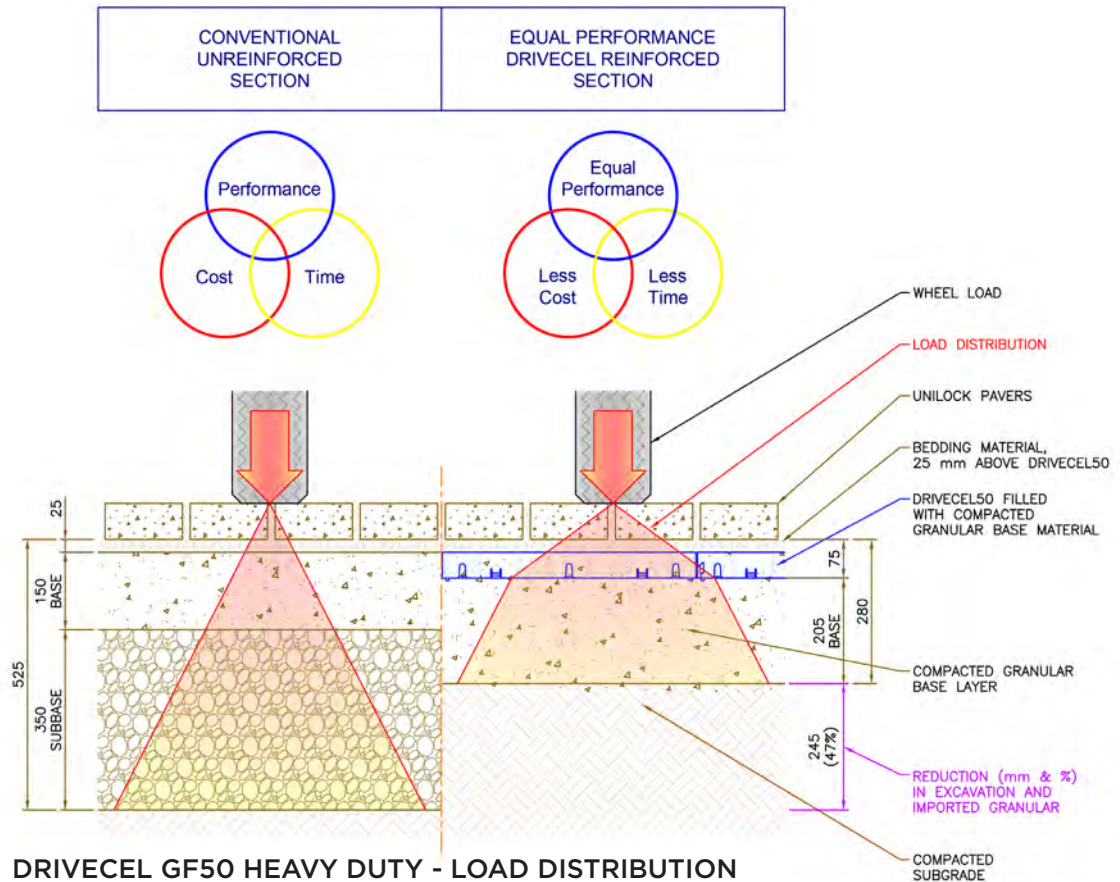

**DRIVECEL GF50 HEAVY DUTY - LOAD DISTRIBUTION**

## PRODUCT ATTRIBUTES

Structure	A Stiff, geocellular confinement system for soil reinforcement and load distribution.
Material	Made of 100% recycled low density polyethylene (LDPE) plastic. Stiff, yet flexible, even at low temperatures (does not become brittle). Long lasting, durable and environmentally friendly. Resistant to biological, chemical and UV degradation.
Performance	Creates a revolutionary Reinforced Soil Structure (RSS) with high tensile and compressive strength to maximize the performance of pavement structures. Extremely permeable; great for permeable pavements. 10 year product guarantee.
Construction	Lightweight and easy to handle. Simple and quick installation. Allows for easy repairs / adjustments after installation.

## PRODUCT SPECIFICATIONS

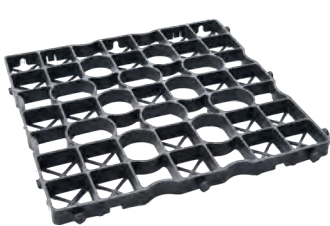

**DRIVECEL30 LIGHT DUTY**  
20 x 20 x 1.2"  
500 x 500 x 30mm

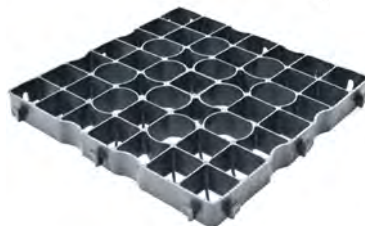

**DRIVECEL50 HEAVY DUTY**  
20 x 20 x 2"  
500 x 500 x 50mm

# TYPICAL APPLICATIONS

## PAVEMENT STRUCTURES

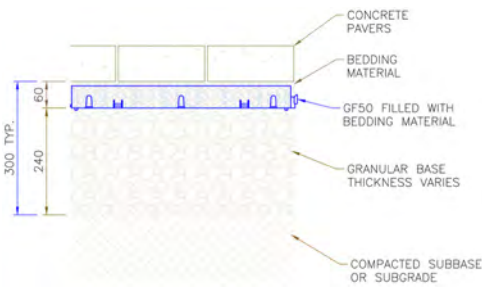

## TRANSITIONS

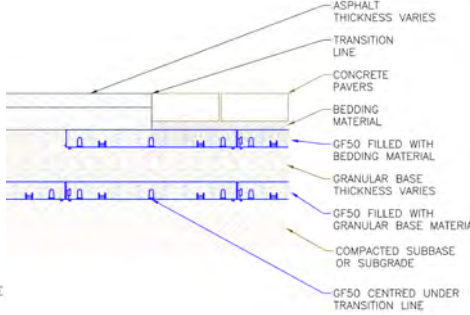

## WALL LEVELLING PADS

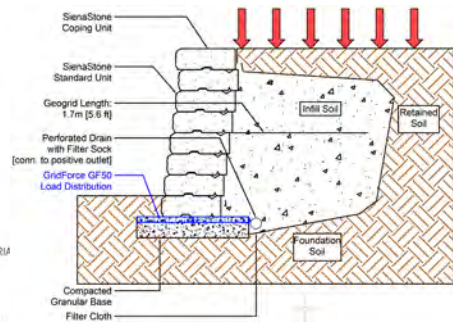

## TECHNICAL INFORMATION

- Conforms to:
- DIN 38412 - Neutral for the environment, lifespan higher than 10 years
  - DIN 4102 - Approval emergency access routes, fire resistance
  - DIN 1072 - Approval for 20 tonne axle load, driveways, road extensions, bridges
  - DIN IN ISO 124 and B125 - Approval for car parks, access roads & storage areas

Maximum Load Capacity = 1,000 tonnes / m<sup>2</sup> (filled)  
 Temperature Range = -35°C to 85°C (-31°F to 185 °F)  
 Tile Wall Thickness = 3 mm (for GF50, GF40 & GF30)  
 Performance Design Life = >100 years

## ENVIRONMENTAL INFORMATION

- Made from 100% recycled plastic
- Recyclable
- Neutral for the environment

## PRODUCT DATA

Tiles & Bundling	Unit	Area Per (m <sup>2</sup> / ft <sup>2</sup> )		Units Per		Per Bundle		Mass Per (kg / lbs)	
	Thickness	Unit	Bundle	Layer	Bundle	Layers	Dimensions	Unit	Bundle
DriveCel30 <i>Light Duty</i>	1.2" (30mm)	0.250 / 2.69	80 / 861.1	4 (2x2)	320	80	1.05 x 1.05 x 2.55 m 3.44 x 3.44 x 8.37 ft	1.1 / 2.4	352 / 776.0
DriveCel50 <i>Heavy Duty</i>	2" (50mm)	0.250 / 2.69	48 / 516.7	4 (2x2)	192	48	1.05 x 1.05 x 2.55 m 3.44 x 3.44 x 8.37 ft	1.6 / 3.5	307.2 / 677.2

Notes: Engineering services are available for site-specific designs and drawings. For more information or for custom options, please contact your Unilock Territory Manager or call 1-800-UNILOCK.

## APPLICATIONS

### Pavement Structure Reinforcement

Under pavers, on subgrade for improvement, multi-layers for maximum performance and durability, conventional and permeable pavements, driveways, patios, walkways, pool decks, roof decks, over parking garages, trails and paths.

### Pavement Transitions

Pavers to asphalt, pavers to concrete, driveways to garage, around catch basins and maintenance holes, over culverts.

### Access Roads

Emergency and fire access, temporary construction access, grassed permeable pavers.

### Foundation Support

Retaining wall levelling pads, outdoor kitchens, barbecues and fireplaces.

### Low Impact Development (LID)

Permeable pavers with water storage in the pavement structure.

### \*Things to know:

Handling and installation - Tiles are installed by laying on the ground and connecting them together with the built-in male and female connectors. Tiles may be driven on while empty for temporary applications. Tiles should be filled and compacted for maximum strength and load distribution.

# DRIVEGRID SYSTEM™

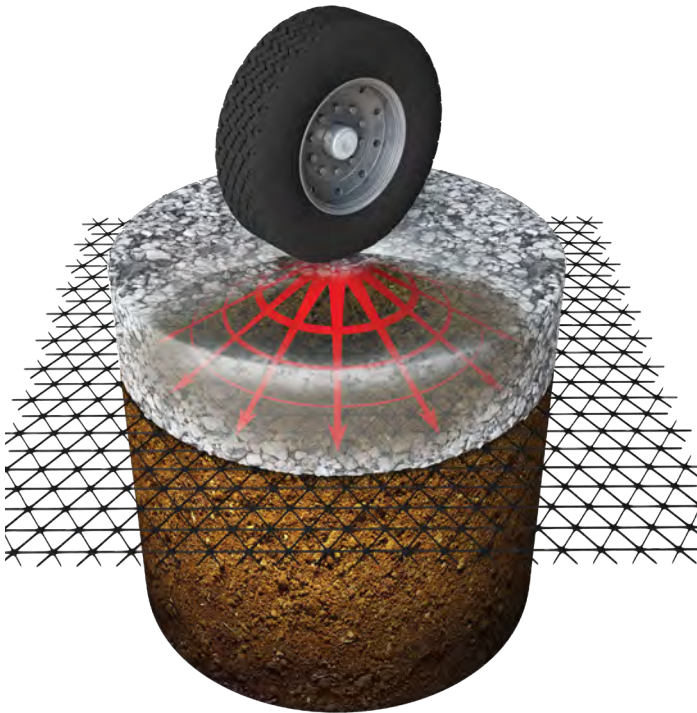

## WHY DRIVEGRID?

- ✓ **EASY TO INSTALL**  
 Rolls are easy to handle and rollout onto the subgrade. It takes only minutes. Rolls can be easily cut in half with a cut-off saw for small projects.
- ✓ **REDUCES OVERALL PROJECT COST**  
 DriveGrid mechanically stabilizes the base so you need less gravel base to accomplish the same load bearing capacity as a deeper base which saves money on base and excavation.
- ✓ **INEXPENSIVE**  
 DriveGrid is very inexpensive to purchase and affects the project cost only marginally. Many contractors see DriveGrid as inexpensive insurance.
- ✓ **PROVEN TENSAR® TRIAX® TECHNOLOGY**  
 Used for extensive road work around the world, the Tensar Triax Technology has proven itself in project performance and longevity.

## PRODUCT ATTRIBUTES

Structure	120' x 13.1' Roll, 1,576 sqft / Roll, 56 lb Roll
Material	Manufactured from a punched polypropylene sheet oriented in multiple, equilateral directions to form its triangular apertures, resulting in high radial stiffness throughout the full 360 degrees. This feature yields a more efficient product that delivers optimal in-service stress transfer from the aggregate to the stabilizing geogrid.
Performance	An advanced product specifically designed for trafficked surfaces. DriveGrid Geogrid's multi-directional properties leverage triangular geometry, one of construction's most stable and widely utilized shapes, to provide an enhanced level of in-plane stiffness. Its triangular structure, coupled with improved rib and junction geometry, offers the construction industry an improved alternative to conventional materials and practices.
Construction	Lightweight and easy to handle. Simple and quick installation. Allows for easy repairs / adjustments after installation.

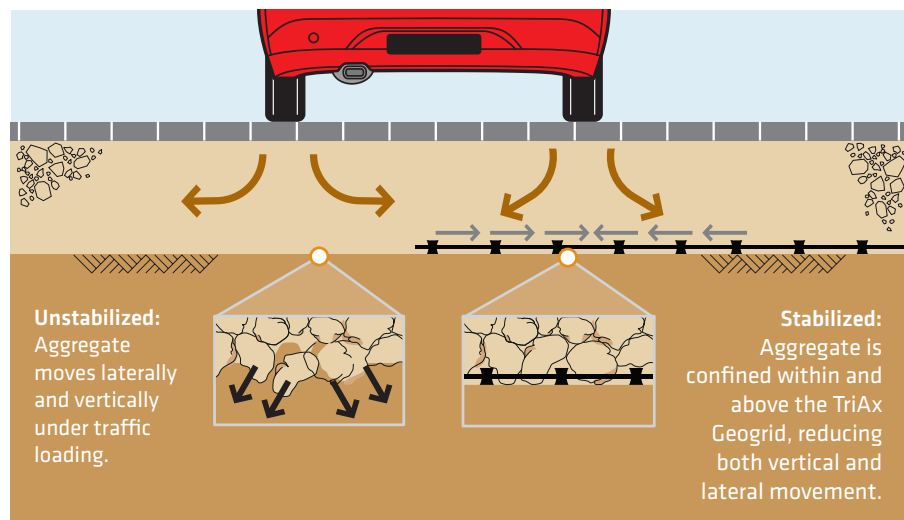

## Potential Base Reduction for Paver Driveways

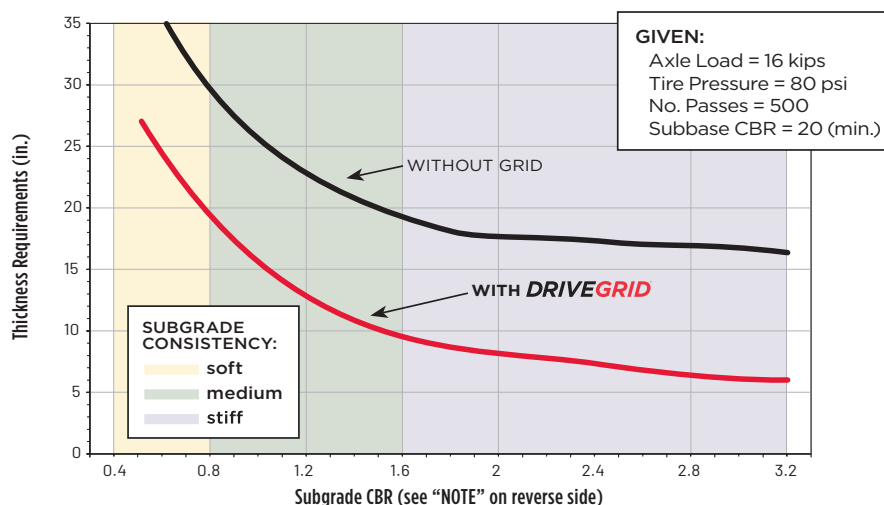

Aggregate thickness is based on Giroud-Han design methodology for unpaved roadways, using 1.5 inch maximum rut depth. Any ruts that occur prior to paver installation should be filled with additional aggregate or bedding material. Additional aggregate will be required if traffic loading or passes will exceed those given above prior to paver installation.

Unilock Drivegrid System™ is a Trademark of Hengestone Holdings Inc. in North America.

## TECHNICAL INFORMATION

### THINGS TO KNOW

Mechanical stabilization of granular bases with geogrid is a proven technology with thousands of miles of roads around the world to its testament. DriveGrid® geogrid, is made with Tensar Triax Technology™ and is a superior geogrid to bi-lateral geogrid in that it provides unilateral stabilization regardless of the load pressure points.

When Unilock learned about the tremendous benefits that are derived from mechanical base stabilization, we made sure to share this technology with our customers and are continuously recommending that they incorporate this inexpensive insurance into every residential hardscape.

Not only is there an increased load-bearing performance when DriveGrid is used, but base thickness can be reduced up to 50% resulting in substantial savings with the reduction of excavation, gravel and compaction time required.

DriveGrid should be used on every project. It is definitely a hardscape best practice and makes good business sense, from initial savings to reduction in project callbacks and repairs.

#### Installation

The installation of DriveGrid is easy. It is simply rolled out and placed at the bottom of your excavation (provided that it is no deeper than 12" (30cm)) before placing the gravel. The gravel sits directly over the geogrid and creates a lock-up of the gravel. The gravel must be an approved road base gradation or a permeable base material like ¾" open graded stone (ASTM No. 57). The maximum benefit of DriveGrid is when it is about 8" below the paver surface. The deeper the base, the less benefit is derived. For additional strength, we recommend 2 layers of grid about 6" apart.

#### PACKAGING

120' x 13.1' Roll  
 1,572 sqft / Roll  
 56 lb / Roll

Visit [contractor.unilock.com/product/unilock-drivegrid/](http://contractor.unilock.com/product/unilock-drivegrid/) for more information and product videos.

**UNICARE™ NATURAL STONE ACIDCLEAN™**

1L and 5L

Removal of:

- Cement Staining
- Efflorescence
- Iron Oxide (Rust)
- Cement mortar
- Grout

Note: Never use hydrochloric or sulphuric acid based products. **ONLY FOR ACID RESISTANT NATURAL STONE.** Carefully read all instructions and safety information on product label prior to application. For additional safety information, see MSDS. Coverage: 10-50 M<sup>2</sup>/L depending on dilution.

**UNICARE™ NATURAL POWERCLEAN™**

1L and 5L

Removal of:

- Oil & Grease
- Food Stains
- General Dirt & Mud
- Light cement contamination (on acid sensitive surfaces)
- Sap & certain plant stains

Note: Carefully read all instructions and safety information on product label prior to application. For additional safety information, see MSDS. For Natural Stone only. Coverage: 10-32 M<sup>2</sup>/L depending on dilution.

**UNICARE™ BIOCLEAN™**

1L and 5L

Removal of:

- Black spot algae
- Green algae
- Plant stains from leaves, wood, trees, berries & flowers
- Organic staining from bark & compost
- Coloured stains from food spillages, tea, coffee and wine

Note: Carefully read all instructions and safety information on product label prior to application. For additional safety information, see MSDS. For Natural Stone only. Coverage: 4-8 M<sup>2</sup>/L depending on dilution.

**ALLIANCE GATOR CLEAN PAVER SHAMPOO**

Gator Clean Shampoo removes ground-in dirt from the surface of concrete pavers and natural stones. It will make the pavers, patio slabs, walls & natural stones look clean and vibrant. Applying Gator Clean Shampoo before a sealer application will assure you of a deeper penetration into the cleaned surface. 1 gal. covers up to 375 sq. ft. Coverage will depend on joint width and surface porosity. Available in 1 gal. & 5 gal.; 4 units of 1 gal./case, 24 cases/pallet; 48 units of 5 gal./pallet.

Note: Carefully read all instructions and safety information on product label prior to application. For additional safety information, see MSDS.

**ALLIANCE GATOR CLEAN EFFLORESCENCE & SLURRY REMOVER**

Gator Efflorescence Cleaner will remove any efflorescence stains trapped in the concrete pavers and natural stone pores. It will make the pavers look more clean and vibrant without discolouring or damaging the paver surface. This efflorescence cleaning is a necessary step before a sealer is applied. The sealer will be able to get a deeper penetration into the now-clean pores. Approximate coverage (diluted) is 200 sq. ft. Available in 1 gal. & 5 gal.; 4 units of 1 gal./case, 24 cases/pallet; 48 units of 5 gal./pallet.

\* ALWAYS DILUTE. ALWAYS TEST. Product can discolour pavers. Read directions carefully.

Note: Carefully read all instructions and safety information on product label prior to application. For additional safety information, see MSDS.

**ROMEX: ROMPOX® D7000 JOINT STRENGTHENER & SURFACE SEALER**

FEATURES: All-in-One, Eco-friendly Jointing Sand Stabilizer and Surface Sealer. Easy topical application that protects against wash out, weed growth and allows for light surface pressure washing up to 1,800 psi once cured. Sealing properties protect the surface from dirt, oil and corrosion from climate exposure and de-icing salt. Compatible with all loose or polymeric sands including ROMPOX® - Fugensand Jointing Sand.

Packaging: 1L / 5 gallon  
48 units of 5 gallon per pallet

IDEAL FOR:

- Joint widths from 1mm (1/16")
- Unbonded construction
- Patios, Walkways, Driveways, Public spaces

Recommended for these Unilock products: Artline, Bronte Street Paver, Brussels Block, Copthorne, Double Holland, Hollandstone, Il Campo, Mattoni, Metro Slab, Northshore, Optiloc, Promenade Plank Paver, Promenade Plank Slab, Revela, Senzo, Series, Soreno Slab, Umbriano 70mm (Vehicular), Windermere Flagstone.

Approximate coverage: 600-800 sqft per 5 gallon container, depending on joint width and surface porosity.

## SEALERS / ADHESIVE / EDGING

**ROMEX: ROMPOX® COLOUR ENHANCER**

**FEATURES:** Surface enhancement solution designed for the refining and visual improvement of the paving surface. Provides surface protection and helps to repel dirt and water. Ideal for indoor and outdoor use thanks to the ROMEX Colour Enhancer's durability and ease of use.

**Packaging:** 1L can  
6 cans per box

**IDEAL FOR:**

- Indoor & Outdoor use
- Private & Public areas
- All Natural Stone, Porcelain, Concrete & Wood paving systems

**UNICARE™ NATURAL STONE MATTE SEALER**

1L and 5L

For Porous Stones - Natural Stone only

- No change of colour
- No surface coating, sheen or shine at all
- Riven Sandstone & Smooth Sandstone

**Note:** Carefully read all instructions and safety information on product label prior to application. For additional safety information, see MSDS. Coverage: 6 M<sup>2</sup>/L depending on dilution.

**UNICARE™ NATURAL STONE COLOUR ENHANCER SEALER**

1L and 5L

Colour Enhancement For Porous Stones (for Natural Stone only)

- No surface coating, sheen or shine
- Breathable
- Lasts several years
- Easy to apply

**Note:** Carefully read all instructions and safety information on product label prior to application. For additional safety information, see MSDS. Coverage: 6 M<sup>2</sup>/L depending on dilution.

**ALLIANCE GATOR NATURAL STONE FINISH + COLOUR ENHANCER - ZERO GLOSS**

Gator Seal for Natural Stone is made of silicone based polymers. This sealer penetrates deep into the natural stone thus reducing the oil and dirt penetration, as well as protecting them from the corrosion of de-icing salt. Approximate coverage 200 - 400 sq. ft. per gallon, depending on stone porosity and other factors. Available in 1 gal. & 5 gal.; 4 units of 1 gal./case, 24 cases/pallet; 48 units of 5 gal./pallet.

**Note:** Carefully read all instructions and safety information on product label prior to application. For additional safety information, see MSDS.

**ALLIANCE GATOR BLOCK POLYURETHANE XP XTRA PERFORMANCE ADHESIVE**

Gator Block XP Adhesive is one of the strongest polyurethane adhesives on the market. It is especially formulated for bonding concrete, natural stones, blocks, bricks and pavers. It is intended to provide a permanent bond to approved materials and can be used on dry or damp surfaces.

Approximate coverage 31 ft per 10oz. / 86 ft per 28oz.; 12 units/case in box sizes.

**ALLIANCE GATOR XTREME EDGE**

**FEATURES:** Gator Xtreme Edge is the ultimate fiber-reinforced structural edge which creates a strong and economical edging solution for any hardscape project. Suitable for any traditional, permeable, Gator Base, or overlay application. Offers permanent continuous lateral support for pavers, slabs, natural and wet cast stone.

**Packaging:** 50 lb bag / 22.7 kg bag  
56 bags / skid

**ALLIANCE GATOR EDGE RIGID & FLEX**

Gator Edge Products are easy to use and quick to install. An excellence choice, it offers great lateral support and makes definition easier for alleys, driveways or sidewalks. They are made with 100% polypropylene or polyethylene for strength and flexibility.

**Packaging:** 24 pcs/bdl  
28 bdls/skid, 1 skid = 5,376 lin.ft.

**PERMA PAVER® CONCRETE EDGING**

**FEATURES:** Perma Paver Edging is 40% more permeable and over 700% more flexible than concrete. Perma Paver Edging uses non-porous aggregates (sand and gravel) so the aggregate will not absorb or retain water like limestone aggregates found in most concretes and mortars which retain water like a sponge, greatly increasing the chance of failure. It also uses a proprietary blend of additives, making it much more permeable than concrete or mortar; allowing water to pass through to avoid freezing in cold climates and not retain moisture in humid warm climates. Perma Paver Edging also contains high strength fibers to prevent separation cracks.

**Packaging:** 75 lb / 34 kg bucket  
36 units per skid

ADHESIVE



HARDSCAPE ACCESSORIES | CLEANERS &amp; SEALERS / ADHESIVE / EDGING

HARDSCAPE  
ACCESSORIES

## SANDS

**ROMEX: ROMPOX® PURE PATIO**

FEATURES: Resin film free Jointing Mortar suitable for residential patios and pathways. Highly water permeable resin jointing solution, specifically designed for the jointing of sensitive surfaces and coated concrete stone slabs. Resistant to ants, weeds, de-icing salt and is pressure washer safe.

Three colours – Neutral, Stone Grey & Basalt.

Packaging – 1kg can / 2.2lb cans (To be mixed with 55lb bag of ROMEX approved filler sand)  
300 cans/skid

IDEAL FOR:

- Pedestrian applications
- Joint widths from 5mm (1/4")
- Residential Patios & Pathways

Recommended for these Unilock products: Beacon Hill Flagstone, Beacon Hill Smooth, Bristol Valley, Eco-Line (Pedestrian application only), Eco-Priora (Pedestrian application only), Eco-Promenade (Pedestrian application only), Granito, Richcliff (Pedestrian application only), Senzo (Pedestrian application only), Town Hall (Pedestrian application only), Treo Smooth (Pedestrian application only), Windermere Smooth (Pedestrian application only), Beacon Hill Smooth Slab, Revela Slab, Richcliff Slab.

**ROMEX: ROMPOX® EASY ECO-FINE**

FEATURES: Ready-mixed, easy to use jointing mortar that is perfect for all pedestrian applications and made from 98% natural, recycled, or renewable raw materials and produced with solar power. ROMPOX® - EASY Eco-Fine can be used around the house on patios, pathways and pool decks, is resin film free, resistant to ants and weeds and is pressure washer safe up to 2,000 psi.

Three colour options – Beige, Grey & Anthracite.

Packaging – 12.5 kg bucket / 27.5 lb bucket  
64 buckets per pallet

IDEAL FOR:

- Joint widths from 3mm (1/8th) on Porcelain Tile
- Joint widths from 5mm on Concrete Pavers
- Residential patios, pathways & pool decks

Recommended for these Unilock products: Arcana Slab, Granite, Natural Stone Slabs, Porcelain Tile Slabs, Umbriano (Pedestrian application only), Umbriano Slab.

**ROMEX: ROMPOX® EASY BUCKET**

FEATURES: Ready-mixed, 1-component, highly water permeable Jointing Mortar perfect for all pavers, including sensitive surfaces. Easy application, ideal for professionals and DIY homeowners. This product does leave a resin-film. After application, it hardens/cures with air/oxygen and becomes vacuum packed. Resistant to ants, weeds and is pressure washer safe.

Three colours – Neutral, Stone Grey & Basalt.

Packaging – 12.5 kg bucket / 27.5 lb bucket  
64 buckets per pallet

IDEAL FOR:

- Joint widths from 5 mm (1/4")
- Residential Patios & Pathways

Recommended for these Unilock products: Beacon Hill Flagstone, Beacon Hill Smooth, Bristol Valley, Eco-Line (Pedestrian application only), Eco-Priora (Pedestrian application only), Eco-Promenade (Pedestrian application only), Granito, Richcliff (Pedestrian application only), Senzo (Pedestrian application only), Town Hall (Pedestrian application only), Treo Smooth (Pedestrian application only), Windermere Smooth (Pedestrian application only), Beacon Hill Smooth Slab, Revela Slab, Richcliff Slab. Arcana Slab, Beacon Hill Flagstone, Beacon Hill Smooth, Granite, Natural Stone Slabs, Porcelain Tile Slabs, Umbriano (Pedestrian application only), Umbriano Slab.

**ROMEX: ROMPOX® FUGENSAND JOINTING SAND**

FEATURES: Eco friendly solid jointing sand manufactured from natural, raw materials which allows for efficient stormwater management and a significantly stronger, more durable paver joint. Quick application and suitable for all load classes with no cement haze or residue thanks to natural polymer binders. Pressure washer safe up to 1,800 psi when used in combination with ROMPOX® D7000 Joint Strengthener & Surface Sealer.

Three colour options – Neutral, Stone Grey & Basalt

Packaging: 55 lb bags / 25 kg bags  
40 bags / skid

IDEAL FOR:

- Joint widths from 1 - 5 mm (1/16" - 1/4")
- Tightly laid or interlocking pavers
- Patios, Walkways, Driveways, Public spaces

Recommended for these Unilock products: Artline, Bronte Street Paver, Brussels Block, Copthorne, Double Holland, Hollandstone, Il Campo, Mattoni, Metro Slab, Northshore, Optiloc, Promenade Plank Paver, Promenade Plank Slab, Revela, Senzo, Series, Soreno Slab, Umbriano 70mm (Vehicular), Windermere Flagstone.

**ROMEX: ROMPOX® FLEX-JOINT JOINTING SAND**

FEATURES: Viscous elastic jointing mortar made of select sands and rubber. Suitable for vehicular rated and unbonded surfaces. Water permeable, self compacting and water emulsifiable during installation. Medium to heavy traffic up to 25 T.

Three colours – Neutral, Stone Grey & Basalt.

Packaging: 25 kg bucket / 55 lb bucket  
24 buckets / skid

IDEAL FOR:

- Unbonded Construction Methods
- Joint widths from 8mm (3/8") - Narrower joints can be jointed with increased work.
- Medium to Heavy Traffic up to 25 T

Recommended for these Unilock products: Courtstone, DuraFlow, Eco-Optiloc, Richcliff Random bundle (Vehicular application)





## SANDS

**ROMEX: ROMPOX® DRAIN**

**FEATURES:** Highly-water permeable two-component Jointing Mortar suitable for driveways, parking spaces and all light vehicular loading applications. Classic resin jointing solution that is self-compacting, water emulsifiable and suitable for all natural stone and concrete surfaces. Resistant to ants, weeds, frost, de-icing salt and is pressure washer safe.

Three colours – Neutral, Stone Grey & Basalt.

Packaging – 2 x 1L bottles (To be mixed with 55lb bag of ROMEX approved filler sand)  
300 resin sets per pallet

**IDEAL FOR:**

- Light vehicle applications up to 3.5 T
- Joint widths from 5mm (1/4")
- All Natural Stone and Concrete surfaces

Recommended for these Unilock products: Beacon Hill Flagstone 80mm, Beacon Hill Smooth 80mm, Eco-Line, Eco-Priora, Eco-Promenade, Town Hall, Treo Smooth, Umbriano 80mm, Windermere Smooth.

*Important Note - During the initial period following installation, a very thin film of epoxy resin remains on the stone surface and intensifies the colour of the stone while protecting it from dirt. The resin film is temporary and will disappear over time due to weathering and abrasion.*

**ROMEX: ROMPOX® D1**

**FEATURES:** Light to medium vehicle rated, two-component Jointing Mortar suitable for driveways, parking spaces and all vehicular loading applications up to 7.5 T. Proven resin jointing solution with increased pouring capacity that is self-compacting, water emulsifiable and suitable for 3mm (1/8") wide joints on all natural stone and concrete surfaces. Resistant to ants, weeds, frost, de-icing salt and is pressure washer safe.

Three colours – Neutral, Stone Grey & Basalt.

Packaging – 2 x 1.25L bottles (To be mixed with 55lb bag of ROMEX approved filler sand)  
150 resin sets per pallet

**IDEAL FOR:**

- Medium vehicle loads up to 7.5 T
- Joint widths from 3mm (1/8")
- All Natural Stone and Concrete surfaces

Recommended for these Unilock products: Eco-Line, Eco-Priora, Eco-Promenade (Heavy-duty Vehicular).

*Important Note - During the initial period following installation, a very thin film of epoxy resin remains on the stone surface and intensifies the colour of the stone whilst protecting it from dirt. The resin film is temporary and will disappear over time due to weathering and abrasion.*

**ROMEX: ROMPOX® PROFI-DEKO**

**FEATURES:** Highly water permeable professional gravel binder for washed, dry and dust-free aggregate. Prevent gravel displacement and reduce ongoing maintenance by creating a strong, visually appealing bound gravel surface. High-strength binder makes Profi-DEKO perfect for pathways, tree pits and decorative gravel areas. Resistant to ants, weeds, frost, de-icing salt and is pressure washer safe.

Colour determined by aggregate selection.

Packaging – 1 x 1L bottle + 1 x 2L bottle (To be mixed with chosen aggregate)  
150 resin sets per pallet

**IDEAL FOR:**

- Pathways & Tree Pits
- Washed, dry and dust-free aggregate
- Sensitive areas – Chemically inert once cured

**ROMEX: ROMPOX® TRASS BED COMPOUND**

**FEATURES:** Highly water permeable and frost-resistant bedding mortar suitable for up to 40 T loading capacity. Suitable for all applications including driveways, patios, walkways, pool decks and is fully compatible with radiant heat systems. Option to use as part of our system guarantee and include ROMEX 10-year warranty – RSG 10. Colour determined by aggregate selection.

Packaging – 55lb bag  
42 bags per pallet

**IDEAL FOR:**

- All applications up to 40 T loading capacity
- Private & Public areas
- All Natural Stone, Porcelain, Concrete & Wood paving systems

**ROMEX: ROMPOX® ADHESION ELUTRIANT**

**FEATURES:** Secure, polymer enhanced paver bond bridge for the laying of natural and concrete stone slabs on ROMEX Trass Bed. As the link between stone and bedding, ROMEX Adhesion Elutriant is an important part of our 10-year system guarantee – RSG 10. Colour determined by aggregate selection.

Packaging – 55lb bag  
42 bags per pallet

**IDEAL FOR:**

- All applications up to 40 T loading capacity
- Private & Public areas
- All Natural Stone, Porcelain, Concrete & Wood paving systems



# SANDS - THE ROMEX® SOLUTION

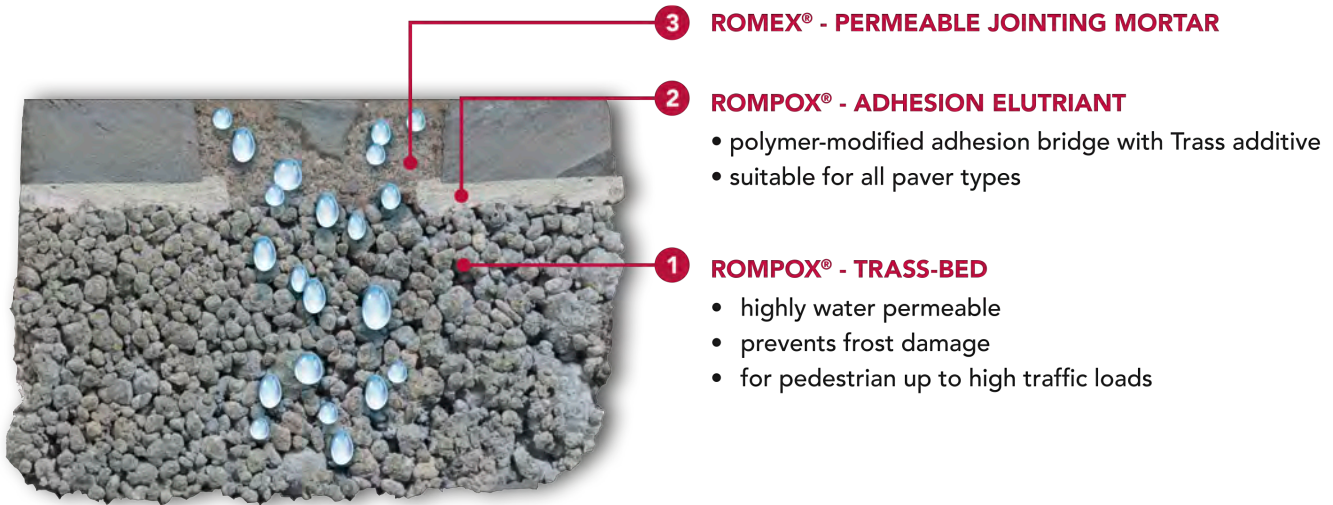

- 3 ROMEX® - PERMEABLE JOINTING MORTAR**
- 2 ROMPOX® - ADHESION ELUTRIANT**
  - polymer-modified adhesion bridge with Trass additive
  - suitable for all paver types
- 1 ROMPOX® - TRASS-BED**
  - highly water permeable
  - prevents frost damage
  - for pedestrian up to high traffic loads

## ROMEX: ROMPOX® TRASS BED & TRASS-BED COMPOUND

High quality, polymer-modified Trass Bed cement is used exclusively in Romex Rompox RSG assemblies because of (1) its superior bonding strength and (2) the Trass mineral additive inherent in its formulation.

In conventional Portland cement products - without Trass - lime particles migrate up through joints, onto the paving surface, and then react with CO<sub>2</sub> in the air. This reaction produces an unsightly, hard white residue on the paving surface which is known as 'efflorescence'.

The key advantage to Trass additive is a near elimination of the risk of efflorescence and avoids the problems it creates with unhappy clients.

In addition to the superior strength of Romex Rompox Trass Bed, it remains highly water permeable. Thus, when used in conjunction with Romex Rompox Permeable Jointing Mortars, a fully permeable bonded construction can be achieved. This provides viable options for stormwater management, and can make a contribution to sustainability and environmental objectives in landscape construction, while still providing a long-lasting, load-bearing, and attractive surface.

## ROMEX: ROMPOX® PEDESTRIAN ON GRADE

### ROMEX® SYSTEM BONDED-RESIDENTIAL & COMMERCIAL

For the **bonded construction** of paving stones on grade pedestrian

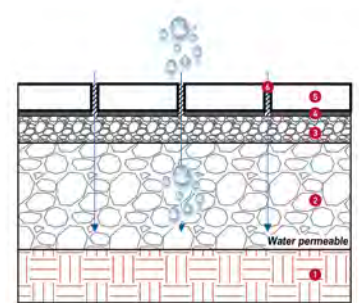
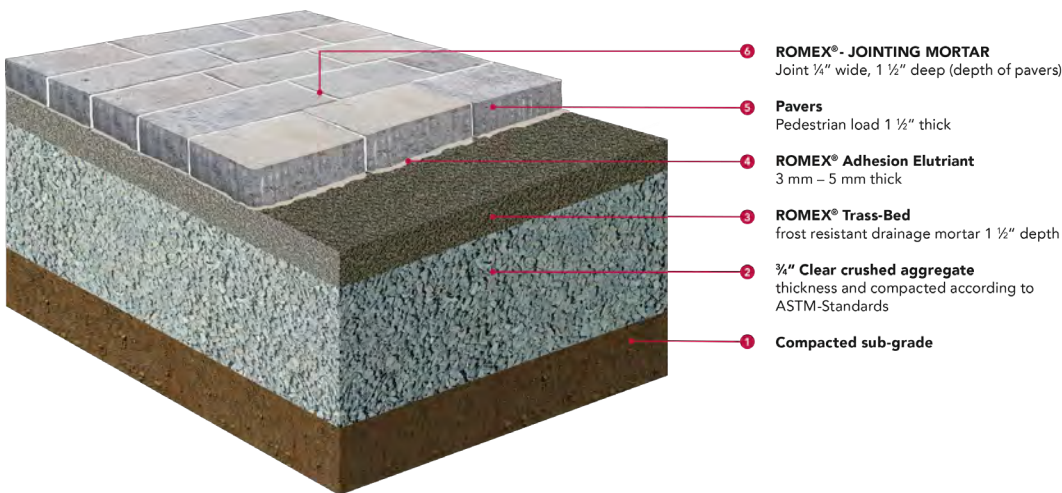

Minimum requirement for fastenings/surface covering: minimum nominal thickness = 50 - 100mm (2-4")

# SANDS - THE ROMEX® SOLUTION

## ROMEX: ROMPOX® REGULAR VEHICULAR ON GRADE (UP TO 3.5 TONS)

### ROMEX® SYSTEM

#### BONDED-RESIDENTIAL & COMMERCIAL

For the **bonded construction** of paving stones on grade vehicle

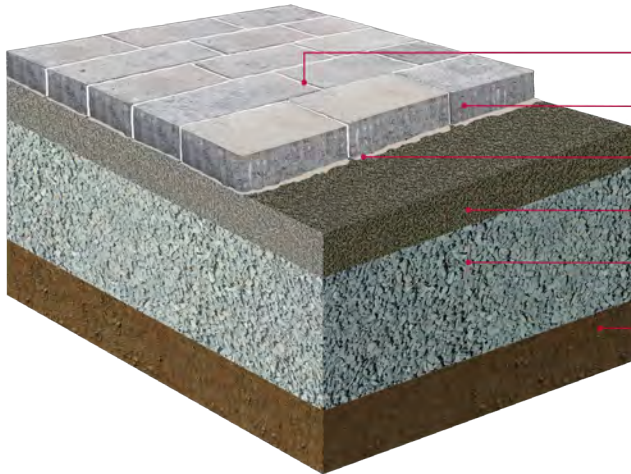

- 6 ROMEX®- JOINTING MORTAR  
Joint 1/4" wide, 2" deep (depth of pavers)
- 5 Pavers  
Pedestrian load 2" thick
- 4 ROMEX® Adhesion Elutriant  
3 mm – 5 mm thick
- 3 ROMEX® Trass-Bed  
frost resistant drainage mortar 2" depth
- 2 3/4" Clear crushed aggregate  
thickness and compacted according to ASTM-Standards
- 1 Compacted sub-grade

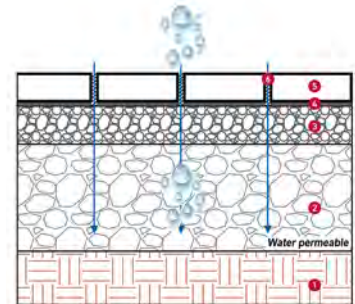

Ideal for garage access, parking spaces, etc. Vehicle traffic up to 20 tons is permitted for occasional use (delivery trucks, emergency vehicles, etc.) Minimum requirement for fastenings/surface covering:  
Minimum nominal thickness = 50 - 100mm (2-4")

## ROMEX: ROMPOX® REGULAR VEHICULAR ON SLAB (UP TO 3.5 TONS)

### ROMEX® SYSTEM

#### BONDED-RESIDENTIAL & COMMERCIAL

For the **bonded construction** of paving stones on slab

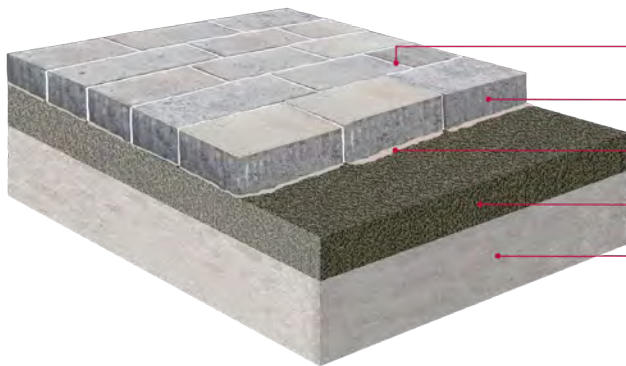

- 5 ROMEX®- JOINTING MORTAR  
Joint 1/4" wide, 2 1/2" deep (depth of pavers)
- 4 Pavers  
Vehicular Street load 2 1/2" thick
- 3 ROMEX® Adhesion Elutriant  
3 mm – 5 mm thick
- 2 ROMEX® Trass-Bed  
frost resistant drainage mortar 2 1/2" depth
- 1 Existing Concrete Structural Slab

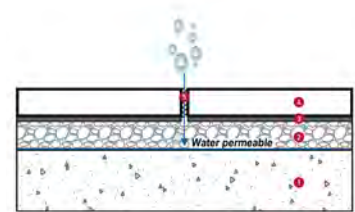

Ideal for garage access, parking spaces, etc. Vehicle traffic up to 20 tons is permitted for occasional use (delivery trucks, emergency vehicles, etc.) Minimum requirement for fastenings/surface covering:  
Minimum nominal thickness = 50mm (2")

# SANDS - THE ROMEX® SOLUTION

## ROMEX: ROMPOX® VEHICULAR ON GRADE - UP TO 25 TONS

### ROMEX® SYSTEM BONDED-COMMERCIAL

For the **bonded construction** of paving stones on grade

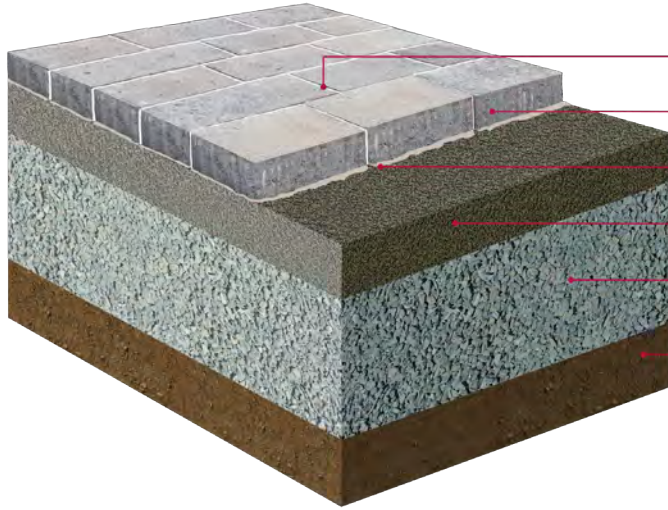

- 6 ROMEX®- JOINTING MORTAR  
Joint 1/4" wide, 3" deep (depth of pavers)
- 5 Pavers  
Vehicular Street load 3" thick
- 4 ROMEX® Adhesion Elutriant  
3 mm – 5 mm thick
- 3 ROMEX® Trass-Bed  
frost resistant drainage mortar 3" depth
- 2 3/4" Clear crushed aggregate  
thickness and compacted according to ASTM-Standards
- 1 Compacted sub-grade

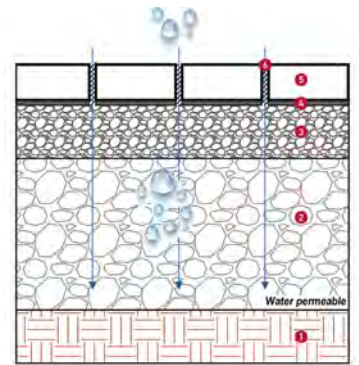

Passenger car traffic including occasional heavy traffic through traffic by vehicles of the entertainment industry. (Eg: residential and residential roads, village main street, district and collection roads. Minimum requirement for fastenings/surface covering: Minimum nominal thickness = 75-100mm (3-4")

## ROMEX: ROMPOX® VEHICULAR ON SLAB - UP TO 25 TONS

### ROMEX® SYSTEM BONDED-COMMERCIAL

For the **bonded construction** of paving stones on slab

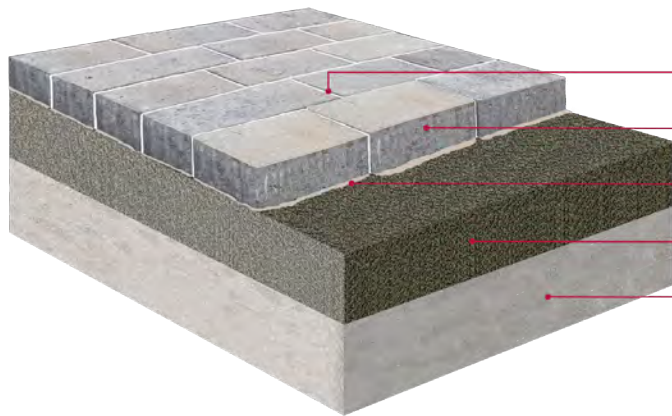

- 5 ROMEX®- JOINTING MORTAR  
Joint 1/4" wide, 2" deep (depth of pavers)
- 4 Pavers  
Vehicular Street load 3" thick
- 3 ROMEX® Adhesion Elutriant  
3 mm – 5 mm thick
- 2 ROMEX® Trass-Bed  
frost resistant drainage mortar 4" depth
- 1 Existing Concrete Structural Slab

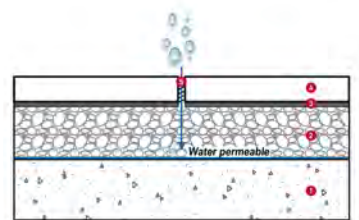

Ideal for garage access, parking spaces, etc. Vehicle traffic up to 40 tons is permitted for occasional use (delivery trucks, emergency vehicles, etc.) Minimum requirement for fastenings/surface covering: Minimum nominal thickness = 75mm (3")

# SANDS - THE ROMEX® SOLUTION

## ROMEX: ROMPOX® ON GRADE VEHICULAR ROMEX® SYSTEM BONDED-COMMERCIAL

For the **bonded construction** with radiant heated paving systems (from pedestrian loading up to light vehicle loads)

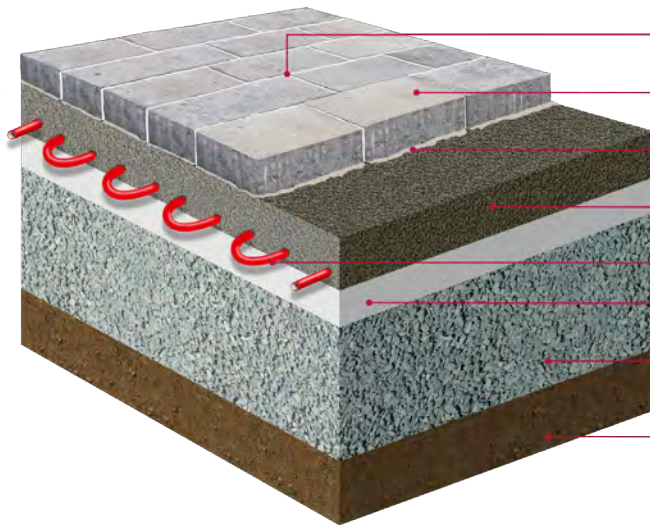

- 8 ROMEX®- JOINTING MORTAR  
Joint ¼" wide, 2" deep (depth of pavers)
- 7 Pavers  
2" min depth
- 6 ROMEX® Adhesion Elutriant  
3-5 mm thick
- 5 ROMEX® Trass-Bed  
Frost resistant drainage mortar
- 4 Radiant Heating
- 3 Ridged insulation  
1 ½" depth
- 2 ¾" Clear crushed aggregate  
thickness and compacted according to ASTM-Standards
- 1 Compacted sub-grade

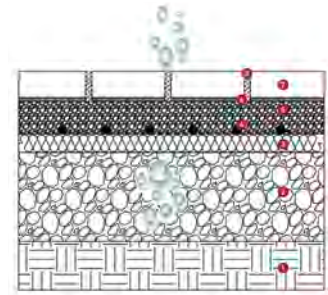

## ROMEX: ROMPOX® UNBOUND ISATEC ANCHOR SYSTEM

### ROMEX® SYSTEM UNBONDED-2-PUBLIC

For the **unbonded construction** of paving and slab coverings from load class 0.3 in accordance with RStO 12. For public areas (roads, paths, squares)

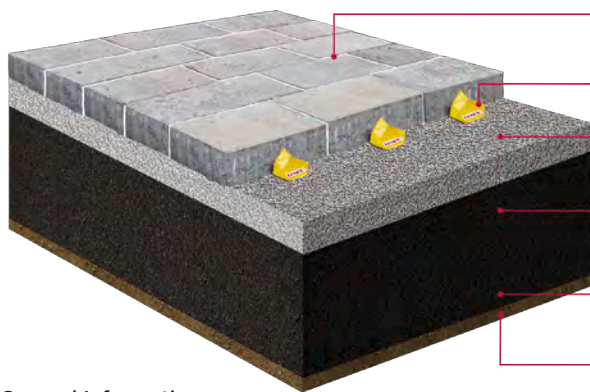

- 8 ROMPOX®- FLEX JOINT  
Joint depth = ½ stone height; Min. joint width 5 mm | ¼"  
(Consumption depending on stone format and joint dimension)
- 7 ISATEC® displacement protection  
(Needs assessment based on site plan and danger areas)
- 6 Bedding  
3-5 cm | 1 ¼"-2" aggregates  
¾, ½ or ⅜ mm according to DIN 18318
- 5 Supporting layer of gravel (30 cm | 11 ¾")  
or gravel, grit, sand mixture  
E<sub>v2</sub> = 150 MPa/m² | 21 756 psi for paving  
and 180 MPa/m² | 26 107 psi for tile coverings
- 4 Frost protection layer of gravel (20 cm)  
or gravel, grit, sand mixture  
E<sub>v2</sub> > 100 MPa/m² | 14 504 psi
- 3 Base/substrate

#### General Information:

Planning a project with paving stones under traffic loads must meet the requirements that prevent the deformation of the surface and subgrade, the breaking and shifting of the pavers. What must also be considered is temporary or unexpected loads on the surface which may occur during the lifespan of the surface in the form of pop-up events such as temporary performance stage or food trucks for example. These can often not be taken into consideration in advance by the planning office or without that information being presented. The pavers must be and arranged in such a way so that the expected traffic loads can also be handled without the need for maintenance or repair work. Changes in use, the increase in heavy axel turning or changes in traffic management can completely alter the existing conditions in the future use of the project planning. For these reasons, it is prudent to take additional measures that prevent damage in any form over the lifespan of the project.

#### Planning:

The engineering and planning consultants have relatively few resources to protect projects against displacement and the aforementioned possible damage caused by this. Although the problem has always been known, attempts were made to use different types of displacement protection devices in many different forms to deal with paver shift and subsequent surface damage.

#### Execution:

Due to the use of ground anchors from ISATec, the construction contractors have the opportunity to ensure a rapid construction process during construction work. The incorporation of the simple and easy to use ISATec displacement protection devices is a real benefit in comparison of some of the previous systems (deep girders, steel rails, etc.) especially when the project timeline is considered. Because of the natural occurring and tolerances, additional cutting and adaptation work is necessary due to the permanently installed and fixed mechanisms. When using ground anchors, these issues are eliminated and planning and execution becomes much more straightforward. Even when the already installed surfaces are dismantled, the ground anchors can be easily removed and re-laid. Shift/displacement protection cannot be more simply utilised than with ISATec. Due to the extensive range of association-oriented displacement protection devices, the corresponding special anchors can be used throughout all types of paving scenarios and where heavy or constant vehicle pressure is applied.



## SANDS - THE ROMEX® SOLUTION

### PRINCIPLE SKETCH: LINEAR AND CURVE APPLICATION

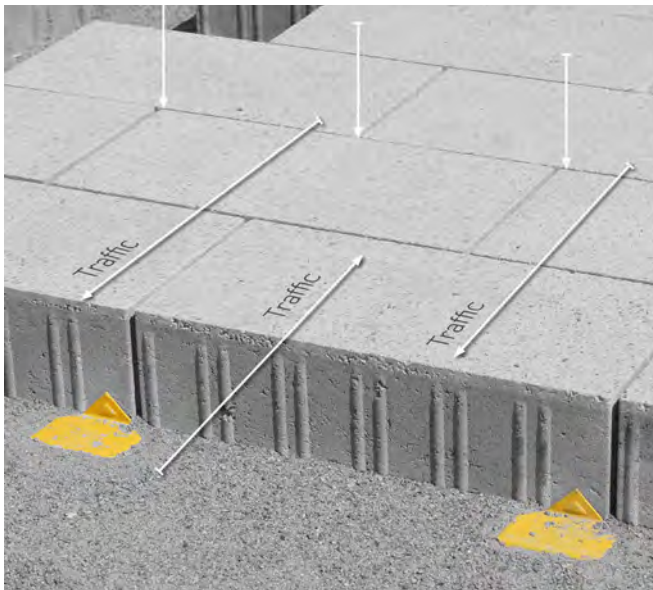
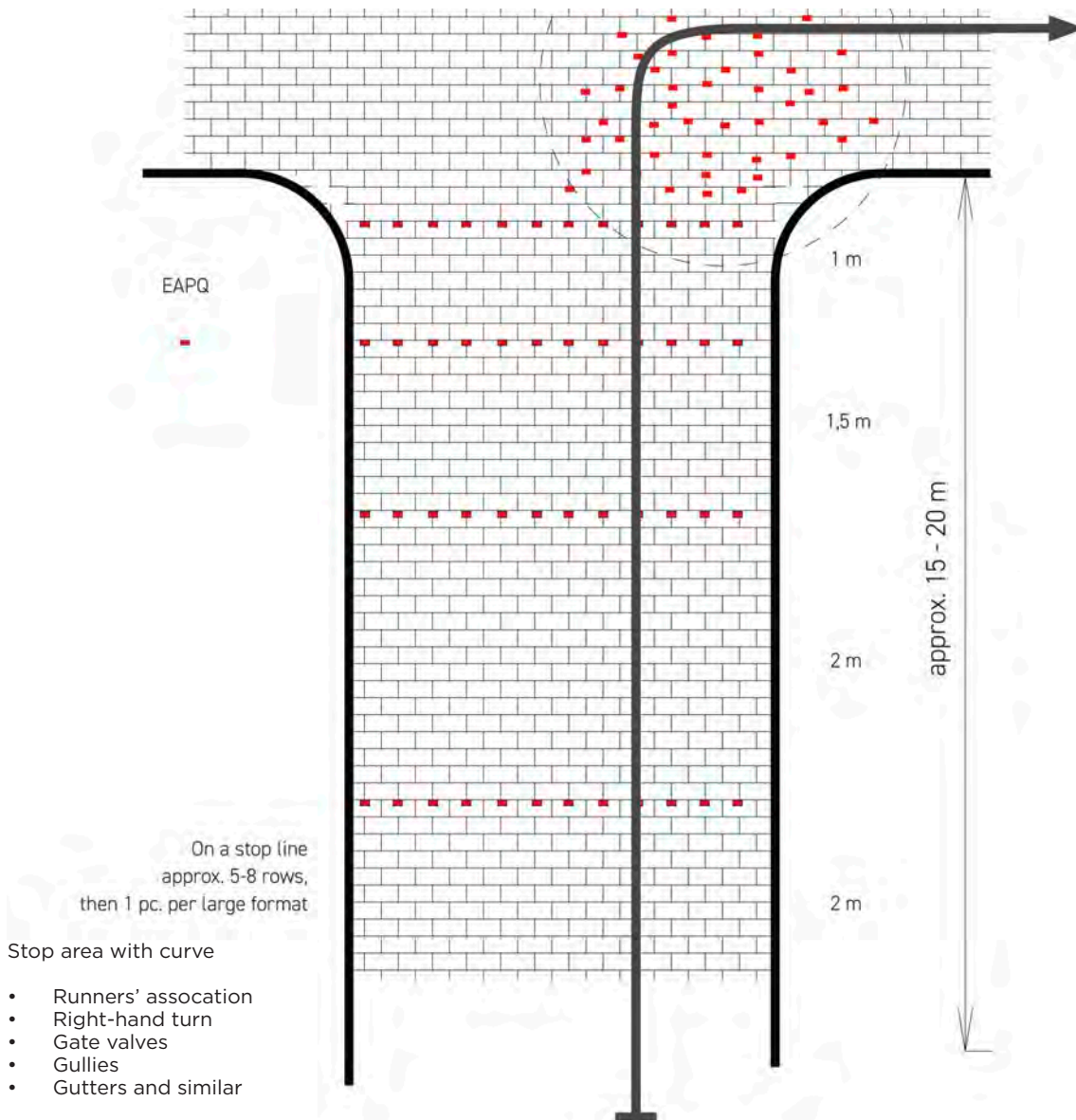

#### APPLICATION TECHNOLOGY -

Linear installation with the displacement protection EAP

The picture shows the most frequently used displacement protection. Especially the types EAP and EAPQ can be used almost universally. Due to the combination, linear structures can be protected and stabilised very well.

Even when the direction of travel changes (curves), the EAPQ displacement protection type can be used. Due to the upwardly angled corners, these displacement protections can absorb additional shear forces.

# SANDS - THE ROMEX® SOLUTION

## PRINCIPLE SKETCH: LINEAR AND CURVE APPLICATION

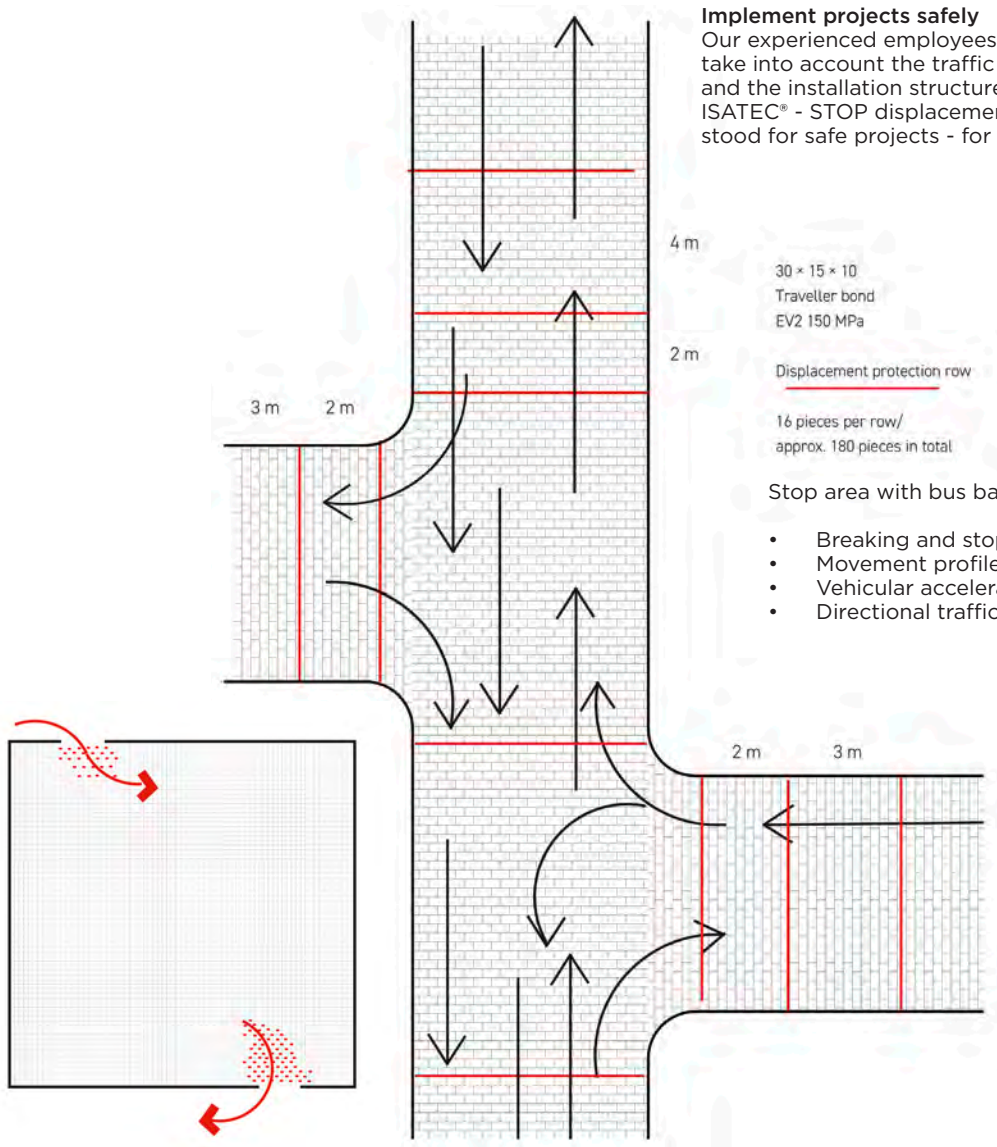

### Implement projects safely

Our experienced employees in the planning technology take into account the traffic load, traffic relations and the installation structure of the exact positioning of the ISATEC® - STOP displacement protections. ROMEX® has stood for safe projects - for decades!

30 × 15 × 10  
Traveller bond  
EV2 150 MPa

Displacement protection row

16 pieces per row/  
approx. 180 pieces in total

### Stop area with bus bay

- Breaking and stopping areas
- Movement profile into the bus bay
- Vehicular acceleration
- Directional traffic

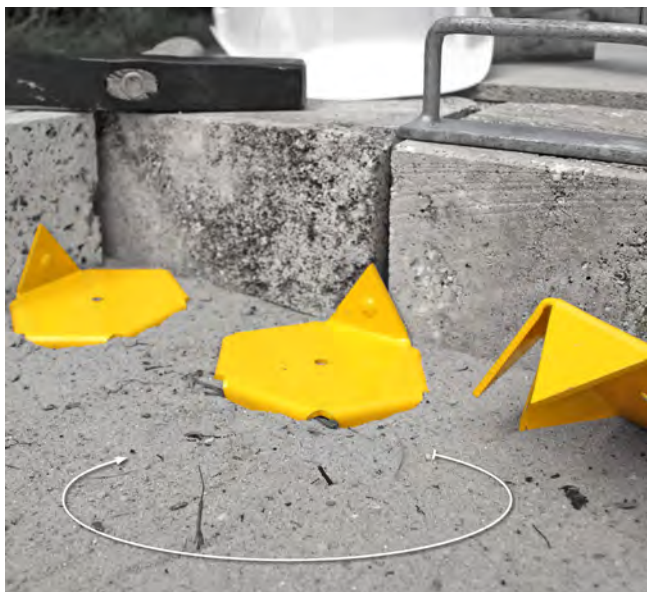

### APPLICATION TECHNOLOGY -

#### Turning Ranges

For circular movements of heavy traffic, displacement protection type EAP should be used. Due to the crimping in the superstructure (every 60°), shear absorption is possible from any approach angle. This ensures twisting of the stones is ensured. Example of use: "Turning ramp".

## SANDS

**ALLIANCE GATOR NITRO JOINT SAND**

**FEATURES:** For outdoor pavers and slabs. 25% faster set time. Sets above 37° F. Ideal for use with Natural Stone, Porcelain Tile, wet cast and concrete pavers and slab installations. 5 year warranty. Only warranted for Porcelain Tile if installed with the Gator Tile System. Best for Patios, Pool Decks and Walkways. Ready to use, no mixing. Works above 3° C.

Four colours - Beige, Black, Grey and Silver

Helps prevent weed sprouting, damages caused by insects, erosion due to climatic conditions.

Packaging: 40 lb pail / 18.1 kg pail  
48 pails per pallet

**ALLIANCE GATOR G2 SUPER SAND (Intelligent Polymeric Sand) - FOR JOINTS UP TO 2" MAXIMUM**

**FEATURES:** Rain safe after 15 minutes; sets above 32° F/0° C but will vary depending on drainage, bedding material, etc. Dust free and haze free. No blower is needed, requires only one watering. 15 year warranty.

Two colours - Beige and Grey

Packaging - 50 lb bags / 22.7kg bags; 70 bags/skid

IDEAL FOR:

- Residential applications
- Concrete paver, wet cast products
- Sloping areas, pool surroundings, patios, walkways, driveways and more

**ALLIANCE GATOR G2 Maxx Sand (Intelligent Polymeric Sand) - FOR JOINTS UP TO 4" MAXIMUM**

**FEATURES:** Rain safe after 15 minutes; sets above 32° F/0° C but will vary depending on drainage, bedding material, etc. Best suited for poor drainage areas. Dust free and haze free. No blower is needed, requires only one watering. 15 year warranty.

Four colours - Beige, Grey, Black and Ivory.

Packaging - 50lb bags / 22.7 kg bags; 70 bags/skid

IDEAL FOR:

- Residential & Commercial applications
- Concrete paver, wet cast products

**ALLIANCE GATOR SUPER SAND - FOR JOINTS UP TO 1" MAXIMUM**

Super Sand is a unique mixture of polymer binders and calibrated sand available in Beige and Grey. The installation of Super Sand Bond is almost identical to using regular paver joint sand except for the application of water. Once Supersand Bond sets, it becomes very firm and locks between the paver joints while still retaining flexibility and providing a long lasting, durable jointing material. Super Sand Bond is recommended for a variety of uses including pool decks, patios, footpaths, driveways, parking spaces, pavements etc. Rain safe after 1 hour; sets above 32° F/0° C. 15 year warranty.

Approximate Coverage: 60 - 85 sqft per 50 lb bag. Available in 50 lb bags/70 bags/pallet.

**Note:** Extra care must be exercised when using on Copthorne®, Courtstone®, Richcliff®, Town Hall® and Umbriano® products. Not suitable for use with Il Campo® and Series™.

**ALLIANCE GATOR MAXX SAND - FOR JOINTS UP TO 2" MAXIMUM**

Gator Maxx Sand is a unique mixture of polymer binders and calibrated sand available in Beige and Grey. The installation of Gator Maxx Sand is almost identical to using regular paver joint sand except for the application of water. Once Gator Maxx Sand sets, it becomes very firm and locks between the paver joints while still retaining flexibility and providing a long lasting, durable jointing material. Gator Maxx Sand is recommended for a variety of uses including pool decks, patios, footpaths, driveways, parking spaces, pavements etc. Rain safe after 1 hour; sets above 32° F/0° C. 15 year warranty.

Approximate Coverage: 60 - 85 sqft per 50 lb bag. Available in 50 lb bags/70 bags/pallet.

**Note:** Extra care must be exercised when using on Copthorne®, Courtstone®, Richcliff®, Town Hall®, and Umbriano® products. Not suitable for use with Il Campo® and Series™.

**ALLIANCE GATOR TILE SAND - FOR PORCELAIN TILE**

**FEATURES:** For outdoor porcelain tile joints in Gator Tile Systems. Fast setting: drainage base 1 hr. Sets above 32° F. Ideal for use with porcelain tile installations. 15 year warranty if used with the Gator Tile Systems. Helps prevent weed sprouting, damages caused by insects, erosion due to climatic conditions. Beige, Grey, Black and Ivory.

Packaging - 35lb bags / 15.9 kg bags

40 units per package

Pallets can be stored outside if covered.

**ALLIANCE GATOR DUST**

**FEATURES:** For Residential applications. For natural stone joints 1/2" to 6". It's ideal for pedestrian patios, walkways, pool decks and many more scenarios. Sets above 59° F (15° C). Fast setting min. 24 hrs without rain. Pedestrian application only. Helps prevent weed sprouting, damages caused by insects, erosion due to climatic conditions. Beige and Grey

Packaging - 50 lb bags / 22.7 kg bags, 70 units per pallet

Pallets can be stored outside if covered.



## SANDS & ACCESSORIES



### ALLIANCE EUROSTONE BOND - THE COURTSTONE® SAND

**FEATURES:** Great for cobblestone and natural stone joints up to 1.5". Sets at above 32° F (0° C). Fast setting: Drainage base systems, min. 1 hr. without rain. Non-drainage base systems, min. of 24 hrs. without rain. More rigid and water resistant. Helps prevent weed sprouting, damages caused by insects and erosion due to climatic conditions. In vehicular application stone must interlock or lay in a concrete bed. Available in Grey.

Packaging - 50 lb (22.7 kg)

56 units per pallet

Pallets can be stored outside if covered.



### ALLIANCE GATOR AQUA ROCK - FOR PERMEABLE PAVERS

**FEATURES:** For Residential and Commercial applications. For permeable paver joints. It's ideal for driveways, parking lots, walkways, drainage applications, bedding and jointing material and many more scenarios. Helps prevent erosion due to climatic conditions. Use as bedding and jointing material. Graded to meet ASTM No. 9. High strength granite stone for long-term use. Helps collect roof and surface water run-off. Reduction of storm water rate. Long-term high infiltration performance.

Packaging - 50 lb bags / 22.7 kg bags

56 units per pallet



### UNILOCK KILN-DRIED REGULAR SWEEPING SAND

Kiln dried and angular shaped in order to flow easily and stay in place.

Packaging - 66 lb/bag

50 Bags/ Skid

## GATOR BASE



**FEATURES:** For Pedestrian use only. Replacement base technology, Gator Base eliminates the need for crushed stone underneath a pedestrian paver project.

GATOR Base is a unique evolution in base technology. Evacuates water through channels along a slope. Manufactured using lightweight high-density polypropylene. Environmentally friendly and 100% recyclable. Extremely durable, will not degrade in the ground. Designed with LOCK-N-GO tongue and groove system.

Packaging - 10 units per pack, 12 packs per box, 120 units per pallet

## GATOR SPACER



**FEATURES:** Provides uniform spacing and unparalleled horizontal and vertical stability to the system. GATOR Block Bond XP penetrates into the rivet holes, adhering the Porcelain tile to the GATOR Spacer, then hardens. This allows the tile to minimize any horizontal or vertical movements.

Available in 3 sizes: Joint widths of 1/8", 3/16" & 1/4"

Packaging: 50 units per pack, 12 packs per box, 144 units per pallet

## GATOR BASE SCREWS



**FEATURES:** Fastening Gator Edge with the Gator Base Screw through the Gator Base reinforces the outside perimeter, creating a strong lateral support. Gator Base Screws are a required component on any Gator Base install.

When using any of the Gator edging on the Gator Base, they must be fastened with Gator Screws only.

Packaging: 50 units per pack, 20 packs per box

## NATURAL STONE GROUTS



### ARDEX X 32™ MICROTEC® - FOR JOINTS UP TO 1¼" (32mm) MAXIMUM - THICK BED

FEATURES: Setting time - 3 hours; ideal for use with moisture-sensitive stone, virtually eliminates staining, warping and discolouration. Water repellent- for fast track swimming pool and wet area applications. Ideal for heavy and large format tiles. The ultimate mortar for interior and exterior stone applications. Excellent slump resistance for floors. Easy to mix and apply; mixes using just water.

Two Colours: Grey and White

Packaging - 40 lb bags / 18 kg bags

IDEAL FOR:

- Residential applications
- Natural Stone, Porcelain, Granite
- Pool surroundings, patios, walkways, roof decks and more



### ARDEX X 77™ MICROTEC® - FOR JOINTS UP TO ⅝" (15mm) MAXIMUM - MEDIUM BED

FEATURES: Setting time - 2 hours; ideal for use with moisture-sensitive stone. Water and frost resistant- ideal for swimming pools and high traffic areas. Unmatched sag resistance - double the ISO standard. Advanced technology for very large, thin porcelain tiles, glass, quarry, ceramic and natural stone. Extremely easy to mix and apply. Extended open time for 60 minutes - double the ISO standard.

One Colour: Grey

Packaging - 40 lb bags / 18 kg bags

IDEAL FOR:

- Residential & Commercial applications
- Natural Stone, Porcelain, Glass, Ceramic, Quarry
- Pool surroundings, patios, walkways, roof decks and more



### ARDEX X 90 OUTDOOR™ - FOR JOINTS UP TO 1¼" (32mm) MAXIMUM - THIN BED

FEATURES: Setting time - 3 hours; ideal for use with moisture-sensitive stone. Highest levels of freeze-thaw resistance. Maximum efflorescence resistance. Ideal for tiling on concrete balconies, patios, swimming pools and high-load commercial areas. Outstanding rapid-setting properties, even at temperatures as low as 40F /5C. Excellent for exterior and interior floors and walls. Heavy and driving rain-resistant after only 2 hours.

One Colour: Grey

Packaging - 40 lb bags / 18 kg bags

IDEAL FOR:

- Residential & Commercial applications
- Natural Stone, Porcelain, Granite
- Pool surroundings, patios, walkways, roof decks and more



### ARDEX FL™ - FOR JOINTS UP TO 1/16" - 1/2" (1.5mm - 12mm) MAXIMUM

FEATURES: Rapid Set, Flexible, Sanded Grout is a high-performance, Portland cement-based, polymer-modified grout that provides a smooth finish for floor and wall tile joints on installations of porcelain, glass, quarry, ceramic, mosaic and most natural stone tiles. Freeze/thaw resistant, stain resistant, water repellent and naturally resistant to mold and mildew formation. Can be open to traffic in just 90 minutes. Excellent flexibility and high strength.

Packaging - 25 lb (11.3 kg) net weight per bag 10 lb (4.5 kg) net weight per box

IDEAL FOR:

- Residential Interior & Exterior floor and wall applications
- Natural Stone, Porcelain, Glass, Ceramic, Quarry
- Pool surroundings and other wet areas with pH- balanced water



### AM 100™ - 1/4" (6 MM) TO 1 1/4" (32 MM) IN 1 LIFT

FEATURES: A unique smoothing and ramping mortar for vertical and horizontal concrete and masonry surfaces that significantly reduces the preparation time prior to the installation of all types of tile and stone. It can also be used to slope balconies and create slope to drains. Perfect for fast-track tiling applications in wet areas.

Packaging - 40 lb (18 kg) net bag weight

IDEAL FOR:

- Residential & Commercial applications
- Natural Stone, Porcelain, Glass, Ceramic, Quarry
- Pools, showers, fountains and below-grade installations, such as subway stations



### ARDEX 8 + 9™ - CRACK ISOLATION UP TO 1/8" (3mm)

FEATURES: Rapid Waterproofing and Crack Isolation Compound is a best-in-class, two-component, solvent-free, cement-based membrane. Rapid setting time as little as 90 minutes. Highly flexible, waterproof coating. This coating protects from topside water infiltration and provides an excellent bonding layer for tile and stone mortars. When properly installed, reduces the risk of efflorescence.

Packaging - 1 gallon (3.78 L)

IDEAL FOR:

- Residential & Commercial applications
- Natural Stone, Porcelain, Glass, Ceramic, Quarry
- Pool surroundings



### ARDEX CA 20 P™ - CONSTRUCTION ADHESIVE & SEALANT

FEATURES: ARDEX CA 20 P™ is a one-component, modified saline, polymer adhesive and neutral curing sealant that hardens in reaction with moisture. ARDEX CA 20 P is extremely flexible with excellent bond strength, making it suitable for a wide range of applications.

Two colours: Grey, White

# ACCESSORIES



## PAVERSAVER UNI MAT

Universal Design - for use on most compactors

The PaverSaver Uni Mat is made out of a specially formulated urethane rubber. This material is soft enough to protect the paver surface and hard enough to minimally affect travel speed. The universal sizing fits most compactor plates and easily attaches and detaches from the compactor.



## ARDEX SK 175™ - WATERPROOFING MEMBRANE AND VAPOR RETARDER FOR TILE AND STONE INSTALLATIONS

**FEATURES:** ARDEX SK 175™ is a pliable, sheet-applied, bonded, water-proof membrane and vapor retarder. It is constructed of polyethylene with a high-performance fleece webbing to securely bond the membrane using Ardex mortars. In order to achieve maximum waterproofing protection, install ARDEX SK 175 with ARDEX 8+9 Rapid Waterproofing and Crack Isolation Compound.

**IDEAL FOR:** Swimming Pools, Balconies and Terraces.

# MISCELLANEOUS ACCESSORIES

RETAINING WALL ACCESSORIES	Unit Dimensions	Package Size	EDGE RESTRAINTS	Unit Dimensions	Package Size
Strata Grid SGU 60 <i>(Previously Strata 200 Grid 6.25' x 288')</i>	Roll: 6' x 300'	-	GATOR/ SNAPEDGE	8' length	24 pcs/ bdl 28 bdl/skid
Strata Grid SGU 100 <i>(Previously Strata 500 Grid 6.25' x 288')</i>	Roll: 12.5' x 360'	-	PERMEDGE	8' length	24 pcs/ bdl <b>(Special Order)</b> 28 bdl/skid
			10" Spikes (Bright)	10" spiral spike	50lbs. per box (approx 250)



## ROMEX® INSTALL TOOL KIT

**FEATURES:** The all-in-one tool kit for ROMEX projects designed to facilitate the best results and finish. The kit includes; coconut broom, industrial broom, coconut hand broom, metal dustpan, squeegee heads, mini handheld squeegee, safety glasses and latex gloves.

**Packaging:** 1 x box  
25 boxes per pallet

**IDEAL FOR:**

- Contractors and Professionals
- All ROMEX Jointing projects
- Multiple projects/applications

HARDSCAPE ACCESSORIES | NATURAL STONE GROUTS / ACCESSORIES

**HARDSCAPE ACCESSORIES**

## GATOR BASE SYSTEM

### Gator Base System

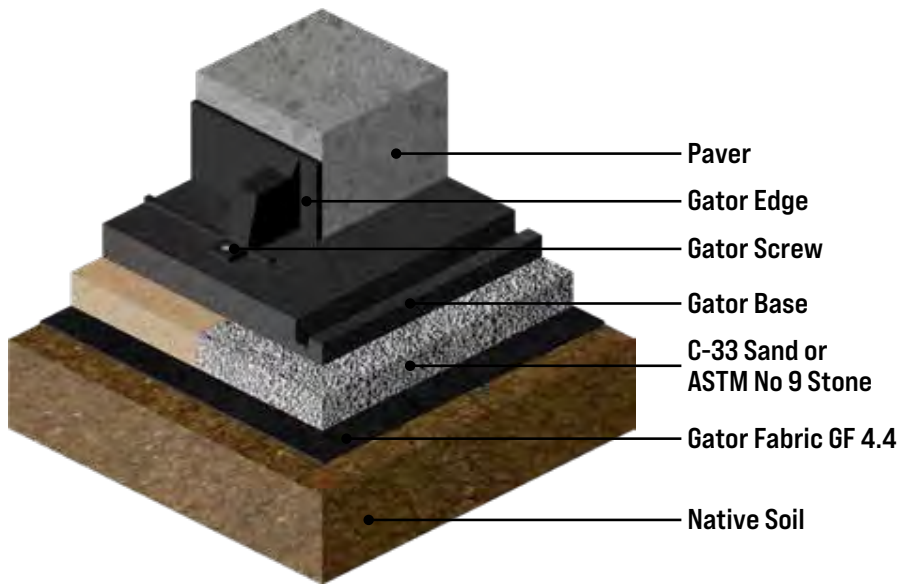

#### STEP 1 • EXCAVATION FOR THE GATOR BASE INSTALLATION

The total depth required will be determined by adding the thickness of the sand or chip setting bed (3/4" [19 mm]), GATOR BASE (3/4" [19 mm]), and thickness of the paver, slab, stone, or porcelain tile. Excavation depth is approximately 4" for a 2 3/8" [60 mm] concrete paver. Excavate 6" (15 cm) wider than the perimeter of the paved surface or 12" wider (30 cm) when building a seating wall or fire pit.

#### STEP 2 • LEVELING AND COMPACTING OF THE SOIL

The bottom of the excavated area should be uniform and smooth (+/- 3/8" [10 mm] in 10') and slope in the same direction as the finished paver surface. Compact the soil using a vibrating plate or hand tamper in confined areas.

#### STEP 3 • ADD GATOR FABRIC GF4.4 AND INSTALL SETTING BED

Cover the bottom and sides of the excavated area with Gator Fabric GF4.4. Spread an even layer of sand (ASTM C33 Concrete Sand) or chip (ASTM No. 9 Stone) in a 3/4" [19 mm] thick layer over the Gator Fabric GF4.4. No compaction is needed for the chip stone. However, the sand-setting bed should be compacted using a hand tamper or vibrating plate. It will help to moisten the sand before compaction. The surface should be smooth, the finished paver surface will mirror the grade set in this step.

#### STEP 4 • INSTALL THE GATOR BASE

Cover the area with the GATOR BASE panels, 6" (15 cm) wider than the finished paver edge or 12" (30 cm) for a seating wall or fire pit. Lay the GATOR BASE units in an alternating (staggered) pattern - if the Gator Faces line up, the interlocking edges will align perfectly. Gator Base can easily be cut to size using a utility knife.

#### STEP 5 • INSTALL PAVERS, BLOCKS AND GATOR EDGE

Place the pavers or blocks directly on the GATOR BASE. Adding a 1/2" (13 mm) of bedding sand onto the surface of the GATOR BASE is also an accepted method for non-uniform thickness stone. Install the Gator Edge on the GATOR BASE, firmly against the pavers or blocks. Use a Gator Base Screw every second edging hole to maximize the lateral support provided by the Gator Edge.

#### STEP 6 • APPLY GATOR MAXX G2 TO PAVER JOINTS

### Gator Tile System

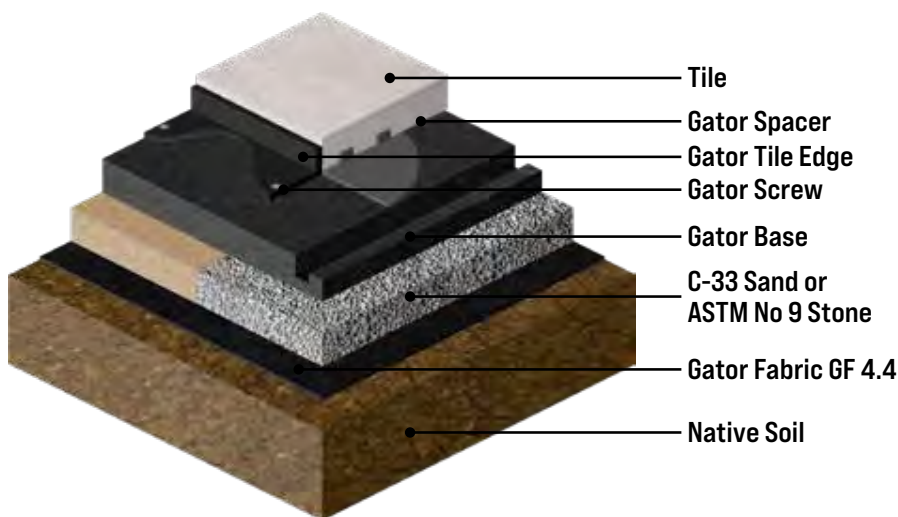

#### FOLLOW STEPS 1 TO 4 OF GATOR BASE SYSTEM

#### STEP 5 • INSTALL GATOR SPACER, GATOR XP GLUE AND TILE

The installation of porcelain tile directly on top of the Gator Base using the GATOR SPACER to provide uniform spacing and unparalleled stability. The GATOR SPACER has been designed to provide the right support, load transfer and a monolithic surface binding all units together with the help of the Gator XP Glue on every quadrants of the Gator Spacer.

#### STEP 6 • INSTALL GATOR TILE EDGE

Install the Gator Tile Edge on the GATOR BASE, firmly against the tiles. Use a Gator Base Screw every second edging hole to maximize the lateral support provided by the Gator Tile Edge.

#### STEP 7 • APPLY GATOR NITRO TO TILE JOINTS

#### Gator Base System



#### Gator Tile System



## BEDDING MATERIALS CHART (APPROXIMATE IMPERIAL TONS)

Bedding Course												
Square Feet	1"	2"	3"	4"	5"	6"	7"	8"	9"	10"	11"	12"
50	0.3	0.5	0.8	1.0	1.3	1.5	1.8	2.0	2.3	2.5	2.8	3.0
100	0.5	1.0	1.5	2.0	2.5	3.0	3.5	4.0	4.5	5.0	5.5	6.0
150	0.8	1.5	2.3	3.0	3.8	4.5	5.3	6.0	6.8	7.5	8.3	9.0
200	1.0	2.0	3.0	4.0	5.0	6.0	7.0	8.0	9.0	10.0	11.0	12.0
250	1.3	2.5	3.8	5.0	6.3	7.5	8.8	10.0	11.36	12.5	13.8	15.0
300	1.5	3.0	4.5	6.0	7.5	9.0	10.5	12.0	13.5	15.0	16.5	18.0
350	1.8	3.5	5.3	7.0	8.8	10.5	12.3	14.0	15.8	17.5	19.3	21.0
400	2.0	4.0	6.0	8.0	10.0	12.0	14.0	16.0	18.0	20.2	22.0	24.0
450	2.3	4.5	6.8	9.8	11.3	13.5	15.8	18.0	20.3	22.5	24.8	27.0
500	2.5	5.0	7.5	10.0	12.5	15.0	17.5	20.0	22.5	25.0	27.5	30.0
550	2.8	5.5	8.3	11.0	13.8	16.5	19.3	22.0	24.8	27.5	30.3	33.0
600	3.0	6.0	9.0	12.0	15.0	18.0	21.0	24.0	27.0	30.0	33.0	36.0
650	3.3	6.5	9.8	13.0	16.3	19.5	22.8	26.0	29.3	32.5	35.8	39.0
700	3.5	7.0	10.5	14.0	17.5	21.0	24.5	28.0	31.5	35.0	38.5	42.0
750	3.8	7.5	11.36	15.0	18.8	22.5	26.3	30.0	33.8	37.5	41.3	45.0
800	4.0	8.0	12.0	16.0	20.0	24.0	28.0	32.0	36.0	40.0	44.0	48.0
850	4.3	8.5	12.8	17.0	21.3	25.5	29.8	34.0	38.3	42.5	46.8	51.0
900	4.5	9.0	13.5	18.0	22.5	27.0	31.5	36.0	40.5	45.0	49.5	54.0
950	4.8	9.5	14.3	19.0	23.8	28.5	33.3	38.0	42.8	47.5	52.3	57.0
1000	5.0	10.0	15.0	20.0	25.0	30.0	35.0	40.0	45.0	50.0	55.0	60.0

Actual volume may vary due to type of materials, moisture content, and compaction. Calculation charts and formulas are provided as a service by Unilock for estimating material requirements. Unilock will not be held responsible in any way for resulting product overage or shortage.

## BASE DEPTH CHARTS (CUBIC YARDS)

Bedding Course												
Square Feet	1"	2"	3"	4"	5"	6"	7"	8"	9"	10"	11"	12"
50	0.2	0.3	0.5	0.6	0.8	0.9	1.1	1.2	1.4	1.5	1.7	1.9
100	0.3	0.6	0.9	1.2	1.5	1.9	2.2	2.5	2.8	3.1	3.4	3.7
150	0.5	0.9	1.4	1.9	2.3	2.8	3.2	3.7	4.2	4.6	5.1	5.6
200	0.6	1.2	1.9	2.5	3.1	3.7	4.3	4.9	5.6	6.2	6.8	7.4
250	0.8	1.5	2.3	3.1	3.9	4.6	5.4	6.2	6.9	7.7	8.5	9.3
300	0.9	1.9	2.8	3.7	4.6	5.6	6.5	7.4	8.3	9.3	10.2	11.1
350	1.1	2.2	3.2	4.3	5.4	6.5	7.6	8.6	9.7	10.8	11.9	13.0
400	1.2	2.5	3.7	4.9	6.2	7.4	8.6	9.9	11.1	12.3	13.6	14.8
450	1.4	2.8	4.2	5.6	6.9	8.3	9.7	11.1	12.5	13.9	15.3	16.7
500	1.5	3.1	4.6	6.2	7.7	9.3	10.8	12.3	13.9	15.4	17.0	18.5
550	1.7	3.4	5.1	6.8	8.5	10.2	11.9	13.6	15.3	17.0	18.7	20.4
600	1.9	3.7	5.6	7.4	9.3	11.1	13.0	14.8	16.7	18.5	20.4	22.2
650	2.0	4.0	6.0	8.0	10.0	12.0	14.0	16.0	18.1	20.1	22.1	24.1
700	2.2	4.3	6.5	8.6	10.8	13.0	15.1	17.3	19.4	21.6	23.8	25.9
750	2.3	4.6	6.9	9.3	11.6	13.9	16.2	18.5	20.8	23.1	25.5	27.8
800	2.5	4.9	7.4	9.9	12.3	14.8	17.3	19.8	22.2	24.7	27.2	29.6
850	2.6	5.2	7.9	10.5	13.1	15.7	18.4	21.0	23.6	26.2	28.9	31.5
900	2.8	5.6	8.3	11.1	13.9	16.7	19.4	22.2	25.0	27.8	30.6	33.3
950	2.9	5.9	8.8	11.7	14.7	17.6	20.5	23.5	26.4	29.3	32.3	35.2
1000	3.1	6.2	9.3	12.3	15.4	18.5	21.6	24.7	27.8	30.9	34.0	37.0

Actual volume may vary due to type of materials, moisture content, and compaction. Calculation charts and formulas are provided as a service by Unilock for estimating material requirements. Unilock will not be held responsible in any way for resulting product overage or shortage.



UNILOCK® COLLECTION OF

# Things to Know

HARDSCAPE ACCESSORIES | BEDDING MATERIAL & BASE DEPTH CHARTS

THINGS TO KNOW

## CALCULATIONS

### AREA OF A CIRCLE

Radius (in.)	18	21	24	27	30	33	36	39	42	45	48	51	54	57
Radius (ft.)	1.50	1.75	2.00	2.25	2.50	2.75	3.00	3.25	3.50	3.75	4.00	4.235	4.50	4.75
Square Feet	7.07	9.62	12.56	15.90	19.63	23.75	28.26	33.17	38.47	44.16	50.24	56.72	63.59	70.85
Circumference (in.)	113.04	131.88	150.72	169.56	188.40	207.24	226.08	244.92	263.76	282.60	301.44	320.28	339.12	357.96
Circumference (Ft.)	9.42	10.99	12.56	14.13	15.70	17.27	18.84	20.41	21.98	23.55	25.12	26.69	28.26	29.83

Area of a circle =  $3.14 \times \text{Radius} \times \text{Radius}$

Circumference =  $6.28 \times \text{Radius}$

### AREA CONVERSION CHART

Square Feet	1	2	3	4	5	6	7	8	9	10	11	12	13	14
Square Meter	0.09	0.19	0.28	0.39	0.46	0.56	0.65	0.74	0.84	0.93	1.02	1.11	1.21	1.30
Square Meter	1	2	3	4	5	6	7	8	9	10	11	12	13	14
Square Feet	10.76	21.53	32.29	43.06	53.82	64.58	75.35	86.11	96.88	107.64	118.40	129.17	139.93	150.69
Cubic Yard	1	2	3	4	5	6	7	8	9	10	11	12	13	14
Cubic Feet	27	54	81	108	135	162	189	216	243	270	297	324	351	378

Area Square = Length x Width

Area Triangle =  $1/2 \text{ Base} \times \text{Height}$

Calculation charts and formulas are provided as a service by Unilock for estimating material requirements. Unilock will not be held responsible in any way for resulting product overage or shortage.

#### \*Paver Maintenance Tips:

- Equip plow scrapers and blades with shoes or high-density plastic blades to reduce the risk of damaging paver joints and the surface.
- Only apply minimum amount of de-icing salts necessary to melt the snow and ice. Remove excess salt after ice melts.
- Regular cleaning routine should include sweeping or blowing loose debris from the pavement surface, and less frequently, deep cleaning with cleaning products and/or water.
- Unilock pavers do not require sealing, however, some people choose to do so for aesthetic purposes.

#### \*Things to know:

Efflorescence is a naturally occurring calcium salt that can sometimes appear on the surface of concrete and clay products. Efflorescence does not affect the structural integrity of concrete, it is a purely aesthetic issue that typically disappears with no further intervention after a season of rainfall. If desired, the process can be accelerated by washing the surface with an Efflorescence Remover.

#### \*Natural Stone Maintenance Tips:

The successful installation of natural stone paving units from Unilock is dependent on the structural integrity of the base below the surface of the slabs. This will include many factors such as wood or concrete decking integrity, site drainage, cutting and quality of concrete mortars and grouts.

Natural stone may be susceptible to staining. When stains do occur, it is imperative that they are cleaned properly and safely to ensure that the appearance is restored and that the surface is not altered or damaged. Natural Stone can often be cleaned with just soap and water. Plain water with a stiff brush (DO NOT use a metal wire brush) is the best start; it won't cause damage to stone. NEVER USE PRESSURE WASHERS on fine finished materials; this can leave marks on the stone.

Organic stains, such as coffee, wine, food, algae etc., on unsealed surfaces, will usually dissipate naturally over time. Natural stone can be sealed to help prevent the penetration of stains. Always observe sealer manufacturer's directions for usage.

Refer to Unilock's Natural Stone Installation Guide for more details. [https://commercial.unilock.com/download/documents/technical-guides/Handling and Installation](https://commercial.unilock.com/download/documents/technical-guides/Handling%20and%20Installation) - Handle and install stones carefully to avoid chipping or surface damage.



## SEALER BEST PRACTICES

- The paver surface should be **clean** and free from oil, dirt, dust and any loose material. This ensures a uniform result and allows the sealer to better penetrate the surface.
- The pavers should be **free of any visible efflorescence**.
- If pavers have been sealed before, make sure to reseat with compatible product.
- **Surface must be dry** (48 hours without precipitation) and warm to the touch (morning).
- Joint sand must also be dry.
- Make sure lawn sprinklers are shut off.
- Best air temperature is between **50 degrees to 80 degrees F** (10 to 27 degrees C) with no rain forecasted for the next 24 hours.
- It is best to apply product under constant weather conditions and use the **same application method from start to finish**.
- The paver joints should be completely filled with dry, correctly-graded joint sand. The top level should not exceed the bottom of the chamfer or **1/8" below** the surface of a non-beveled or tumbled paver surface.
- **Always test the product** on a small hidden area to ensure the results will meet your expectations.
- Always show homeowners samples to ensure expectations.

At this point read all sealer instructions and determine the best sealer for your desired goal. Do you want to retain the original look, enhance the colour, or stabilize the sand joint?

- **Read application information as each sealer can be applied differently.**
- **Make sure you have the correct equipment based on type of sealer. Solvent based sealers need solvent resistant sprayers, watering cans or paint trays.** Water base sealers can be generally applied using plastic equipment. Example: Solvent based sealers are not packaged in plastic containers for this reason.
- Always back roll during application to ensure that excess sealer is not left to pool on the surface of the pavers. When using solvent based sealers make sure roller is solvent resistant or for all paints. Foam rollers work best and are less likely to pull sand from the joints.
- Stabilizing sealers are generally sprayed or flood coated with a watering can, then back rolled.
- Acrylic non-stabilizing sealers can be sprayed, then back rolled or rolled on using a metal paint tray.
- **Send your most experienced worker to do sealing projects.**

## POLYSAND BEST PRACTICES

- Ensure that paver surface has **proper drainage runoff** (Min 1" over 8'). Finished paver height should always be higher than grade to allow proper surface drainage.
- **Do not set pavers in limestone screenings.** This product holds moisture and does not meet the gradation, drainage qualities or strength of coarse concrete sand.
- Make sure that pavers are **clean of all construction dust, as this will prevent hazing. Compact pavers** into setting bed to create proper interlock.
- Read and review manufacturer's instructions prior to application.
- **Don't rush polysand installation.**
- **Paver area must be completely dry.**
- Lay bags over paver area, based on approximate coverage per bag (ie: one bag per 60 square feet).
- **Do not over sweep sand.** Sweep sand back and forth within coverage area to fill paver joints.
- **Compact sand into joints.** This is a must in achieving proper density of the sand joint (repeat 3 times). Compaction is critical to assuring sand strength.
- Do not completely fill the joint with sand. The top level should not exceed the bottom of the chamfer, or 1/8" below the surface of a non-chamfered or tumbled paver.
- Using a fine-bristle broom, **remove any excess sand** from the paver surface.
- Using a **leaf blower**, remove any sand or binder residue.
- **Review all watering directions (Each manufacture has different watering instructions.) This is VERY IMPORTANT!**
- Always start watering at the **bottom of the slope**.
- Always start watering in **controlled areas** per manufacturer's recommendations. Example: complete watering in 200 sqft area then move on to the next 200 sqft and repeat.
- During final watering of polysand, **clean surface by removing excess water** with leaf blower or squeegee depending on paver surface texture. This will remove any leftover binder residue or sand.
- Final thoughts - Always be aware of the weather when installing polysand, as temperature and setting time ratings will differ based on the product.
- Refer to all manufacturers' websites for installation videos.

### IMPORTANT NOTICE

**Unilock Polymeric Jointing Sand, cleaners and sealers, must always be applied by a trained and experienced professional. Contact your Unilock Territory Manager for training and the most up-to-date best practices.**

**NOTICE: Unilock does not accept any responsibility for damage to the surface caused by the improper application and use of Unilock polymeric sand, sealers or cleaners. Unilock will not accept responsibility for alternate suppliers of polymeric sand, jointing sand, cleaners and sealers.**

1. **EXTRA CARE** must be exercised when using Polymeric Sand on the following products:

EnduraColor™      Courtstone®      Copthorne®      Richcliff®      Town Hall®

Unilock Polymeric Jointing Sand can be used on these products but the fine polymers and binders in Unilock Polymeric Jointing Sand have a natural tendency to adhere to the surface and therefore extra diligence must be taken to pre-clean the surface prior to "wetting the sand in" and squeegee off the surface post application. Failure to do so will result in a whitish haze on the surface that is difficult to remove.

2. **IMPORTANT COMPACTION NOTICE:** Always pre-compact the pavers WITHOUT SAND IN THE JOINTS. This will facilitate proper leveling. Polymeric sand can then be swept into the joints. *Always use a compactor with a protective membrane attached to the bottom of the plate.*

**UNILOCK**

# IMPORTANT NOTES

## UNILOCK PAVER PATTERNS

This Product Resource Guide contains extensive references to patterns and designs, the purpose of which is to help designers plan unique and exceptional designs. Percentages of products shown are based on the pattern and not bundle configurations, which may lead to situations where a pattern has been created using only one size of a Random/Mixed bundle. In such cases, the designer will have to make adjustments as to how the other components are used in their overall plan (this is often accomplished by using them in a border or accent). The designer and/or installer of Unilock products accepts all responsibility for design and all associated costs incurred as a result of applying any of Unilock's suggested design patterns in a project. Please plan and review your project carefully prior to placing orders.

## TRANSFERABLE LIFETIME GUARANTEE

Unilock provides a transferable lifetime guarantee on the structural integrity of its paving stones to the original purchaser of the product for residential use. If material installed, using our installation guidelines, proves to be defective, it will be replaced without cost. Colour matching cannot be guaranteed, and replacement labour is not included. Proof of purchase is required. Excessive defective material (over the industry accepted normal of 2% for non-tumbled unit pavers) delivered to the purchaser will be replaced free of charge if a written claim is made within 5 days of delivery from the manufacturer. Such claims will not constitute reason for delaying payment. All goods shall be deemed accepted if completely installed. Inspect concrete products prior to opening bundle packaging to ensure that shape and colour are as ordered. Unsatisfactory material must be available for inspection by Unilock to entitle the purchaser to any adjustment or credit. Inspect all concrete units during installation and set aside any which are chipped or cracked to use for any cut pieces required. The colour of concrete products may vary significantly between production lots. Always install concrete units from several bundles simultaneously to ensure proper distribution of colour. Prior to final compaction, inspect installed pavers for good colour distribution. Relocate certain pavers, if necessary, to achieve desired colour blend.

## PRODUCT HANDLING WARNING

**Bundle Straps Under Tension - Use extreme caution when removing or handling straps.** Always wear gloves, goggles, safety footwear, and protective clothing when removing or handling straps. Failure to do so may result in serious bodily injury or loss of sight.

Cut all concrete products only in well ventilated areas. Inhalation of dust is a serious health risk. A "NIOSH" (US) or a "CSA" (CDN) approved respirator, safety goggles, hearing protectors, and gloves must be worn at all times. Always "wet-cut" or "wet grind" concrete products to minimize dust.

Do not stack bundled concrete products higher than 2 bundles high. Contents of the bundle may be unstable and subject to topple when stacked. Always use extreme caution and appropriate equipment when transporting or storing bundled concrete products. Failure to do so may result in serious bodily injury or death. Always obey gross vehicle weight (GVW) loading limitations and regulations.

Hazard Rating: Fire 0, Health 1, Reactivity 0. See MSDS Concrete Masonry (Pavers). Contact Unilock for complete sheet or view safety information at [www.unilock.com](http://www.unilock.com)

***Unilock assumes no liability or responsibility for loss or damage, resulting from the improper use or handling of our products, or from failure to follow instructions, warnings, and/or advisories on the product label, and on the MSDS sheet.***

Umbriano® is a trademark of Metten Stein + Design GmbH & Co KG used under license by Unilock.

Unilock Ltd. and Hengestone Holdings, Inc. are the owners or authorized users of all trademarks used in this publication unless otherwise specified.

Measurements throughout this portfolio are nominal.

\*Colours shown should be used only as a guide. Colours should always be chosen from actual samples. Contact your Unilock Territory Manager for colour availability in your area.

Not all products shown are available at all Unilock locations. Log onto [www.unilock.com](http://www.unilock.com) for availability.

## FINISHES

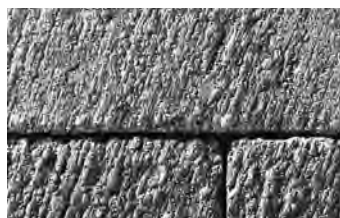

BRUSHED



COBBLESTONE



WEATHERED

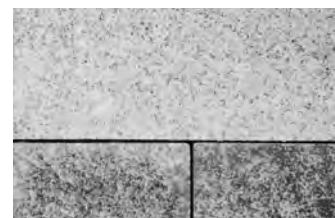

SMOOTH - ZERO BEVEL



FLAGSTONE



SMOOTH

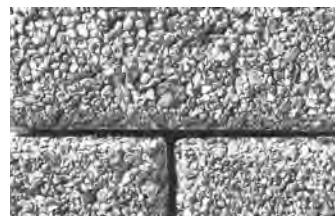

WASHED



STANDARD



SPLIT



TIMEWORN



SPLIT AND WEATHERED

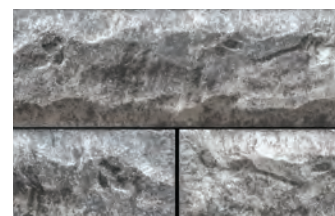

PITCHED FACE

## COLOUR BLEND DESCRIPTIONS

COLOUR NAME	DESCRIPTION	COLOUR NAME	DESCRIPTION
Almond Grove	Tan, Buff and Charcoal	Limestone	Light Grey
Basalt	Blue & Black	Mahogany Ash	Mid Brown and Light Charcoal
Black Granite	Black Granite and Charcoal	Metallic Grey	Midtone Grey
Buff	Tan	Mica Grey	Natural Grey
Burgundy Red	Plum with Red	Midnight Charcoal	Dark Charcoal
Burnt Clay	Brown with Red	Midnight Sky	Charcoal and Black Flake
Charcoal	Charcoal	Modena	White with Grey and Tan Flake
Cliffside Grey	Charcoal, Buff and Natural	Mountain Mist	Midtone Grey
Cocoa Brown	Solid Dark Brown	Notte	Mid Charcoal, White and Light Natural
Coffee Creek	Sandstone, Brown and Charcoal	Oak Brown	Taupe, Black and Buff
Corvara	White, Grey and Tan	Old Oak	Tan and Brown
Cremo	Cream and Buff	Opal Blend	Light Grey and White
Crystalline Basalt	Granite with Black	Pebble Taupe	Tan and Brown
Dark Brown	Dark Brown	Peppered Granite	White aggregates with Black Flecks
Dark Charcoal	Dark Charcoal	Pewter	Light Grey
Dawn Mist	Grey and Tan	Rustic Red	Red and Charcoal
Dusk	Grey, Tan and White	Sabia	Brown, Black and Light Natural
Fossil	Charcoal, Natural and Tan	Sable Blend	Cream, Tan and Brown
French Grey	Mid Grey with White Fleck	Safari	Cream and White
Frost	White with Grey and Tan Flake	Sandstone	Buff and Tan
Glacier	White Granite with Black Granite	Savannah	Tan and Brown
Golden Sand	Tan	Sierra	Charcoal, Russet and Buff
Granite	Charcoal and Natural	Sierra Fusion	Charcoal, Russet and Buff
Granite Fusion	Charcoal, Natural and White	Steel Grey Blend	Dark Charcoal and Grey
Granite Mist	Charcoal, Grey and Natural	Sterling	White, Tan and Grey
Grenada White	White and Grey	Summer Wheat	Cream White with Pale Yellow & Beige Particles
Ice Grey	Grey and White	Terra Cotta	Salmon and Charcoal
Indiana Buff	Grey and Tan	Tuscany	Sandstone and Tan
Irish Coast	Natural, Tan and Russet	Vivanto	Charcoal and Tan
Light Grey	Light Grey	Winter Marvel	White and Black Flake

PRODUCT DIRECTORY			PAVERS & SLABS					ONTARIO		
Product	Page	Thickness	Finish	Pedestrian	Residential Vehicular	Commercial Vehicular	Heavy Duty	Environmental	For Borders & Accents	
Arcana™ Slab	94	50mm	S	✓						
Artline™	6	70mm	S	✓	✓					
Beacon Hill™ Flagstone (60 & 80mm)	8, 10	60,80mm	FS	✓	80mm only	80mm only			✓	
Beacon Hill™ Smooth (60 & 80mm)	12, 14	60,80mm	SM	✓	80mm only	80mm only			✓	
Beacon Hill™ Smooth Slab	96	60mm	SM	✓						
Black Oyster Granite Slab	130	25,50mm	SM	✓						
Black River Limestone Slab	114	22mm	SM	✓						
Bristol Valley™ (60 & 80mm)	16,18	60mm	FS	✓						
Bronte™ Street Paver	20	100mm	W	✓	✓	✓	✓			
Brussels Block™	22	70mm	W	✓	✓	✓			✓	
Bucine Bluestone Sandstone Slab	112	38mm	FL	✓						
Castle Grey Granite Slab	132	25,50mm	SM	✓						
Copthorne™	24	60mm	T	✓	✓				✓	
Courtstone™	26	60mm	C	✓	✓				✓	
Dura-Flow™	28	80mm	S		✓	✓		✓		
Dura-Mat™	30	100mm	S			✓		✓		
Eco-Line™	32	100mm	S	✓	✓	✓	✓	✓		
Eco-Optiloc™	34	80mm	S	✓	✓	✓	✓	✓		
Eco-Priora™	36	80mm	S	✓	✓	✓	✓	✓		
Eco-Promenade™	38	100mm	SM	✓	✓		✓	✓	✓	
Galaxy Frost Granite Slab	134	25,50mm	FL	✓						
Granito™ (60mm- Random, 70mm- Hex)	40	60,70mm	SM	✓ Hex	✓ Hex	✓ Hex	✓ Hex		✓	
Greyfield Sandstone Slab	116	22mm	BB	✓						
Hollandstone™ / Double Holland™	44	60,80mm 60,80mm	S	✓	✓ Hollandstone™ 80mm	✓ Hollandstone™ 80mm	✓ Hollandstone™ 80mm		✓	
Il Campo™	46	70,80mm	B	✓	✓				✓	
Indian Coast Sandstone Slab	118	22mm	BB	✓						
Ivory Sand Sandstone Slab	120	22mm	BB	✓						
Load Lock	48	100mm	S/SB/SM	✓	✓	✓	✓	✓		
Mattoni™	50	70mm	T	✓	✓				✓	
Metro Slab™	98	60mm	SM	✓					✓	
Nordic Cobble™	52	60mm	SB	✓	✓			✓	✓	
Northshore™	54	70mm	F	✓	✓					
Optiloc™	56	80mm	S	✓	✓	✓	✓			
Porcelain Tile Slabs	124-129	20mm	SM	✓						
Promenade Plank™	58	100mm	S/B/WS	✓	✓	✓ 4x12 100mm	✓		✓	
Promenade Plank™ Slab	100	100mm	S/B/WS	✓	✓					
Revela™	60	80mm	SB	✓	✓	✓				
Revela™ Slab	102	60mm	SB	✓						
Richcliff™	62	60mm	FS	✓	✓				✓	
Series™ (70mm)	64	70mm	WS	✓	✓				✓	
Series™ (100mm)	66	100mm	WS	✓	✓	✓			✓	
Skyline™	106	50mm	SM	✓						
Soreno™ Slab	104	50mm	S	✓						
Stone Cliff Grey Sandstone Slab	122	22mm	FS	✓						
Town Hall™	68	70mm	T	✓	✓	✓		✓	✓	
Treo™ Smooth	70	80mm	SM	✓	✓	✓		✓		
Tribeca Cobble™	72	70mm	C	✓	✓			✓	✓	
Turfstone™	74	80mm	S		✓			✓		

**Finishes:** B=Brushed; BB= Blasted & Brushed; C=Cobblestone; D=Dimpled; DW=Dimpled and Weathered; FS=Flagstone; FL=Flamed; P= Pitched; S=Standard; SB=Shotblast; SM=Smooth; SZ=Smooth Zero Bevel; SP=Split; SP/W=Split and Weathered; T=Timeworn; W=Weathered; WS=Washed. This application chart should only be used as a guide. Site conditions, base materials, pattern, and frequency of use may vary the performance of various types and styles of products.

PRODUCT DIRECTORY		PAVERS & SLABS					ONTARIO			
Product	Page	Thickness	Finish	Pedestrian	Residential Vehicular	Commercial Vehicular	Heavy Duty	Environmental	For Borders & Accents	
Umbriano® (60mm)	76	60mm	SM	✓					✓	
Umbriano® (70mm)	78	70mm	SM	✓	✓	✓ Hex			✓	
Umbriano® (80mm)	80	80mm	SM	✓	✓	✓			✓	
Umbriano® (100mm)	82	100mm	SM	✓					✓	
Umbriano® Slab	108	60,70,100 mm	SM	✓						
Urban Line	110	60mm	SM	✓						
Westport™ Smooth	84	70mm	SM	✓	✓				✓	
Windermere™ Flagstone	86	70mm	FS	✓	✓				✓	
Windermere™ Smooth	88	70mm	SM	✓	✓				✓	

PRODUCT DIRECTORY		RETAINING WALLS - SINGLE OR DOUBLE-SIDED WALLS							ONTARIO	
Product	Page	Finish	Gardens	Retaining Walls	Steps	Heavy Duty	Seatwalls	Pillars		
Brussels Dimensional Stone®	138	W	✓		✓		✓	✓		
DuraHold®	140	S	✓	✓		✓				
DuraHold2®	142	S		✓		✓				
Lineo™ Dimensional Stone	144	S	✓							
Pisa	146	SP	✓	✓	✓			✓		
Pisa Smooth™	148	SM	✓	✓	✓			✓		
SienaStone™	150	SP		✓	✓	✓				
SienaStone™ Smooth	152	SM		✓	✓	✓				
SonomaStone™	154	SP		✓	✓	✓				
U-Cara®	156-161	S / P	✓	✓	✓		✓	✓		

PRODUCT DIRECTORY		STEPS, TREADS & COPING							ONTARIO	
Product	Page	Finish	Gardens	Retaining Walls	Steps/Treads	Heavy Duty	Seatwalls	Pillars		
Brussels Fullnose™	164	W	✓		✓		✓	✓		
Ledgestone™ Pillar Caps & Coping	166	P	✓	✓	✓	✓		✓		
Ledgestone™ Steps	177	P	✓		✓					
Natural Stone Coping (Limestone)	173	P	✓	✓	✓		✓	✓		
Natural Stone Coping (Bucine)	175	P	✓	✓						
Natural Stone Coping (Sandstone)	174	P	✓	✓	✓		✓	✓		
Natural Stone Steps (Limestone)	180	SM / P	✓		✓					
Natural Stone Steps (Bucine)	182	P	✓	✓	✓					
Natural Stone Steps (Sandstone)	181	SM / P	✓		✓					
Pisa Coping	168	S / P	✓	✓	✓	✓	✓	✓		
Pisa Smooth™ Coping	169	SM	✓	✓	✓	✓	✓	✓		
SienaStone™ Steps	178	SP	✓		✓					
SienaStone™ Smooth Steps	179	SM	✓		✓					
Umbriano® Coping	170	SM	✓	✓	✓		✓	✓		
Universal Coping	171	SM	✓	✓	✓		✓	✓		
Urban Line Coping	172	SM	✓	✓	✓		✓	✓		

**Finishes:** B=Brushed; BB= Blasted & Brushed; C=Cobblestone; D=Dimpled; DW=Dimpled and Weathered; FS=Flagstone; FL=Flamed; P= Pitched; S=Standard; SB=Shotblast; SM=Smooth; SZ=Smooth Zero Bevel; SP=Split; SP/W=Split and Weathered; T=Timeworn; W=Weathered; WS=Washed. This application chart should only be used as a guide. Site conditions, base materials, pattern, and frequency of use may vary the performance of various types and styles of products.

# UNILOCK PAVER REFERENCE GUIDE

UNILOCK PAVERS	Classic	EnduraColor	Elegance	Comfort Step	ClassicCoat	EasyClean	Reala	Ultima	ColorFusion	Permeable	Vehicular
Arcana™		•				•					
Artline™		•									•
Beacon Hill™ Flagstone 60mm		•									
Beacon Hill Flagstone 80mm		•									•
Beacon Hill Smooth 60mm		•									
Beacon Hill Smooth 80mm		•									•
Beacon Hill Smooth Slab		•									
Bristol Valley®		•									
Bristol Valley 80mm		•									•
Brussels Block®	•										•
Copthorne®			•			•	•	•			•
Courtstone®			•			•	•	•			•
Double Holland™	•										•
Eco-Priora™	•	•								•	•
Eco-Promenade®		•								•	•
Granito™ Random Bundle		•				•					
Granito Hex		•				•					•
Il Campo®		•									•
Hollandstone™	•										•
Il Campo®		•									•
Mattoni™		•									•
Metro Slab™	•				•						
Nordic Cobble™		•								•	•
Northshore™		•		•							•
Promenade™ Plank		•									•
Revela™		•									•
Revela Slab		•									
Richcliff®		•	•			•	•	•			•
Series™		•									•
Skyline™		•				•*					
Soreno™		•		•		•					
Treo® Smooth		•								•	•
Town Hall®			•			•	•	•		•	•
Tribeca Cobble™		•								•	•
Umbriano® 60mm		•				•					
Umbriano® 80mm		•				•			•		•
Umbriano 70mm		•				•			•		•*
Umbriano 100mm		•				•			•		
Urban Line 60mm		•									
Windermere™ Flagstone	•										•
Windermere Smooth	•										•

## UNILOCK WALL REFERENCE GUIDE

UNILOCK WALLS	Classic	EnduraColor	Two-Sided	Garden	Engineered
Brussels Dimensional	•		•	•	
Lineo™ Dimensional	•		•	•	
Pisa™	•			•	•
Pisa Smooth	•		•	•	•
SienaStone™	•		•		•
SienaStone™ Smooth	•		•		•
U-Cara®		•	•	•	•

## UNILOCK STEPS REFERENCE GUIDE

UNILOCK STEPS	Classic	Reala	Natural
Ledgestone™		•	
SienaStone	•		
SienaStone Smooth	•		
Natural Stone Sandstone			•
Natural Stone Limestone			•

## COPING PAIRINGS REFERENCE GUIDE

UNILOCK COPINGS	Ledgestone	Universal	Natural Stone	Brussels Fullnose	Pisa	Umbriano
Brussels Dimensional	•	•	•	•		•
Lineo Dimensional Stone	•	•	•			•
Pisa		•	•		•	
Pisa Smooth	•	•	•	•	•	•
U-Cara	•	•	•			•



Scan here to access our complete index of paver and wall products.

LEED, Leadership in Energy & Environmental Design, is a green building certification that recognizes best-in-class building strategies and practices that have a positive impact on the health and occupants, while promoting renewable, clean energy. To receive LEED certification, building projects must satisfy prerequisites and earn points to achieve different levels of certification. Unilock products can help with your certification goals.

## POTENTIAL LEED CREDITS FOR UTILIZING PERMEABLE PAVERS

### RAINWATER MANAGEMENT: LEED V4

Up to three points can be achieved for retaining rainwater onsite based on the percentage kept. 85% (zero lot line projects only) - 3 points, 95% - 2 points and 98% - 3 points. (all except Healthcare - subtract 1 point). See LEED v4 for more specific project/site details.

### HEAT ISLAND REDUCTION - NON-ROOF: LEED v4

Paving materials with a three-year aged solar reflectance (SR) value of at least 0.28. If three-year aged value information is not available, use materials with an initial SR of at least 0.33 at installation OR use an open grid pavement at least 50% pervious - 2 points (except Healthcare - 1 point). See LEED v4 for more specific site calculations.

### SOLAR REFLECTANCE

Solar Reflective Index (SRI) is a criterion used by USGBC that measures values of sunlight and radiation bouncing from built surfaces. It is used to measure urban heat island effects in city centres. Dark pavement absorbs heat during the day and then releases it at night. This process creates a situation that causes urban centres to stay warmer all the time which contributes to air pollution and increased energy consumption. Careful selection of materials and colours can help reduce urban heat island effects. Solar reflectance is the most important characteristic of a roof product in terms of yielding the highest energy savings during warmer months. The higher the solar reflective value the more efficient the product is in reflecting sunlight and heat away from the building and reducing roof temperature.

### MATERIALS AND RESOURCES: LEED V4

- > Building Product Disclosure and Optimization - Sourcing of Raw Materials - Sourcing of Raw Materials and Extraction • 1 point
- > Building Product Disclosure and Optimization - Sourcing of Raw Materials - Leadership Extraction Practices • 1 point
- > Building Product Disclosure and Optimization - Material Ingredient Reporting - Material Ingredient Reporting • 1 point
- > Building Product Disclosure and Optimization - Material Ingredient Reporting - Material Ingredient Optimization • 1 point
- > Building Product Disclosure and Optimization - Environmental Product Declaration • 1 point

*Values may change slightly by region due to variations in local aggregate and granite.*

*Please be sure to contact your Unilock Territory Manager for a comprehensive and current list of SRI product values.*



# UNICARA®

## THE MOST COMPLETE HARDSCAPE WALL SYSTEM



*Check out the possibilities!*



**UNILOCK**

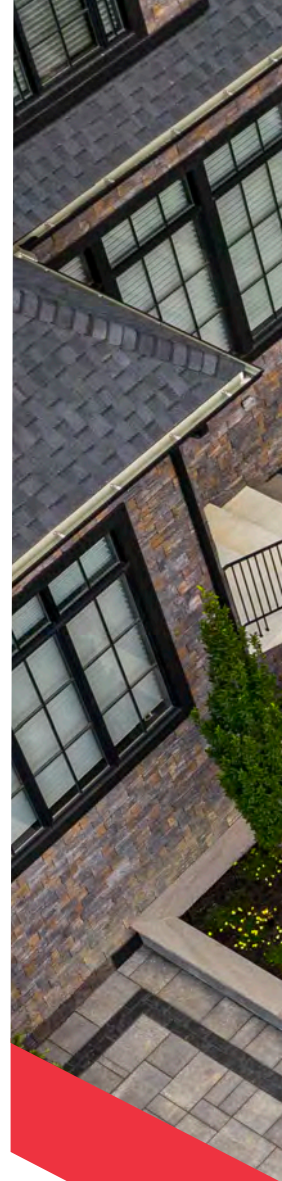

# Let's **BUILD YOUR BUSINESS** together.

**CONTACT 1-800-UNILOCK OR VISIT UNILOCK.COM TO  
CONNECT WITH YOUR LOCAL TERRITORY MANAGER**

**BOSTON**  
(508) 278-4536

**MILWAUKEE**  
(262) 742-3890

**MICHIGAN**  
(248) 437-7037

**MID-ATLANTIC**  
(202) 798-2060

**CHICAGO**  
(630) 892-9191

**KANSAS**  
(913) 417-7985

**NEW YORK**  
(845) 278-6700

**ONTARIO**  
(416) 646-9000

**UNILOCK.COM | 1-800-UNILOCK**

©2023 Hengestone Holdings, Inc.