

# UNILOCK NATURAL STONE

## INSTALLATION GUIDE



**UNILOCK**<sup>®</sup>  
DESIGNED TO CONNECT.

# NATURAL STONE

## INSTALLATION GUIDE



### TABLE OF CONTENTS

Disclaimer, Installation, PPE, Cleaning, Acids, Sealers..... 2 & 3

#### AGGREGATE BASE

Open Graded or Compacted Granular Base.....4

#### OVER CONCRETE

Concrete Overlay - Good Surfaces.....5

Concrete Overlay - Poor Surfaces .....6

#### OVER WOOD

Wood Deck Veneer  
- *Structural Underlayment for Elevated Decks*..... 7

Wood Deck Veneer  
- *Low Profile Pedestal*.....8

#### SPECIALTY APPLICATION

Pedestal on Concrete Application .....8

Pool Coping and Pool Deck.....9

Unicare Cleaners & Sealers .....10

Ardex Preparation & Installation Mortar ..... 11

The successful installation of natural stone paving units from Unilock is dependent on the structural integrity of the base below the surface of the slabs. This will include many factors such as wood or concrete decking integrity, site drainage, cutting and quality of concrete mortars and grouts.

### INSTALLATION

1. All installations and their respective bases indicated in this guide, should always be installed on undisturbed native subsoil. Provisions for drainage and frost protection are ultimately the installer's responsibility and can be managed by slope, drains or depth of base.
2. Only use cementitious adhesives, modified mortars and grouts that are approved for exterior use. Cementitious bedding is typically made up of three parts masonry sand and one part Portland Type I or Type II cement. Always observe manufacturer's directions and be sure to conform to all ACI (American Concrete Institute) and PCA (Portland Cement Association) standards. Always install in accordance with ASTM C615, Standard Specification for Granite Dimension Stone; ANSI/CTI A108.1. Note: Bond/Slurry coats should always be applied to all surfaces to be adhered. Ardex 8+9 is recommended (see page 11)
3. Building code requirements may vary. Always review local building codes prior to design and construction.
4. Use only approved geotextiles and geogrids.
5. **DO NOT** compact the surface of natural stone paving units with a plate compactor.
6. Use only diamond blades specifically designed for cutting natural stone paving units. Always "wet-cut" natural stone and wash slurry from both surfaces before installing.
7. Impervious sub-structures must always be sloped for drainage or be designed with provisions for drainage. Both the base and the slab surfaces should have an endfall slope away from the buildings and structures at 1:40. The opposite crossfall slope should be 1:80.
8. Thicknesses of base, concrete and bedding indicated in these details are typical. Actual design specifications should always be determined by a qualified professional. All base materials must be placed over undisturbed subsoil and compacted to 95% SPD. Never lay product on topsoil.
9. Natural Stone slabs installed over wood decking must have impervious jointing compound between joints to prevent water from rotting the wood overtime.

# NATURAL STONE

## INSTALLATION GUIDE



### PERSONAL PROTECTIVE EQUIPMENT (PPE)

Personal Protective Equipment (PPE) should be worn on site such as goggles, N100 stone dust rated masks and gloves, especially when the units are being cut. A minimum requirement for personal protective equipment on site should include a hardhat, protective gloves, protective shoes and high visibility clothing.

### CLEANING



Natural stone may be susceptible to staining. When stains do occur, it is imperative that they are cleaned properly and safely to ensure that the appearance is restored and that the surface is not altered or damaged. Natural Stone can often be cleaned with just soap and water. Plain water with a stiff brush (DO NOT use a metal wire brush) is the best start; it won't cause damage to stone. **NEVER USE PRESSURE WASHERS** on fine finished materials; this can leave marks on the stone.

Organic stains, such as coffee, wine, food, algae etc., on unsealed surfaces, will usually dissipate naturally over time. Natural stone can be sealed to help prevent the penetration of stains. Always observe sealer manufacturer's directions for usage.

**Always test cleaners and sealers on an unobtrusive area of the installation to ensure that the cleaner is producing the desired outcome before applying to the entire project.**

### ACIDS

**NEVER** use Hydrochloric or Sulphuric (Muriatic) Acid based cleaners to remove pointing/grouting residue from natural stone.

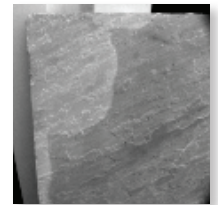

*Light area indicates damage from acid.*

Phosphoric acid-based cleaners can be used on acid-resistant sandstones and granites.

**NEVER** use any acid on limestone.

### SEALERS

Any sealer applications in wet areas such as pool decks or patios should be done with impregnating sealers that remain "breathable". See manufacturer's specifications.

Products that **form a film are not recommended** for most applications because they do not allow moisture to get through and may also be slippery when wet.

**Always test a small area in an unobtrusive location before sealing entire area.**

### • Recommended Sealers and Cleaners

Unilock offers a complete line of sealers and cleaners for the Natural Stone products we sell. Please refer to page 10 of this guide or visit [Unilock.com/nat-stone-guide.pdf](https://unilock.com/nat-stone-guide.pdf)

# NATURAL STONE

## INSTALLATION GUIDE



### OPEN GRADED OR COMPACTED GRANULAR BASE

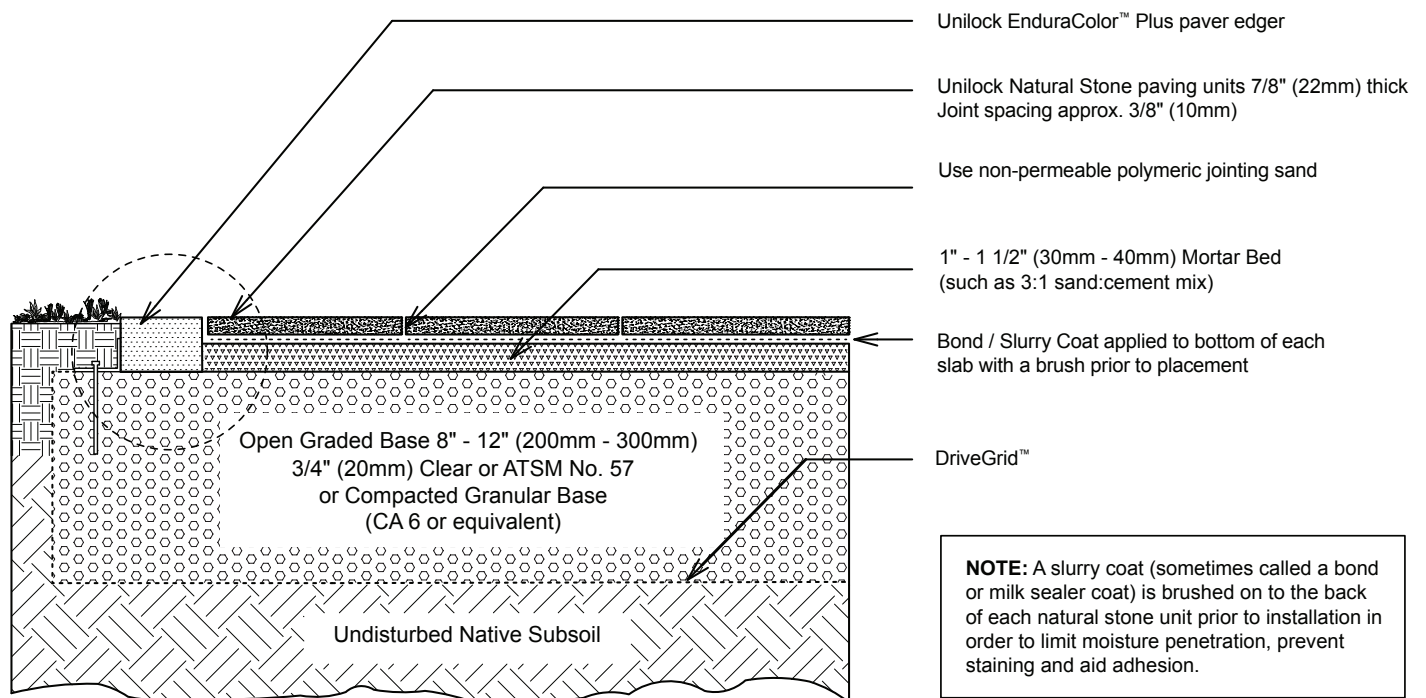

**NOTE:** A slurry coat (sometimes called a bond or milk sealer coat) is brushed on to the back of each natural stone unit prior to installation in order to limit moisture penetration, prevent staining and aid adhesion.

**\*NOTE:** Cement stabilized chip is a mixture of 80% open graded chip and 20% portland cement with enough water to create a pasty yet flowable mix.

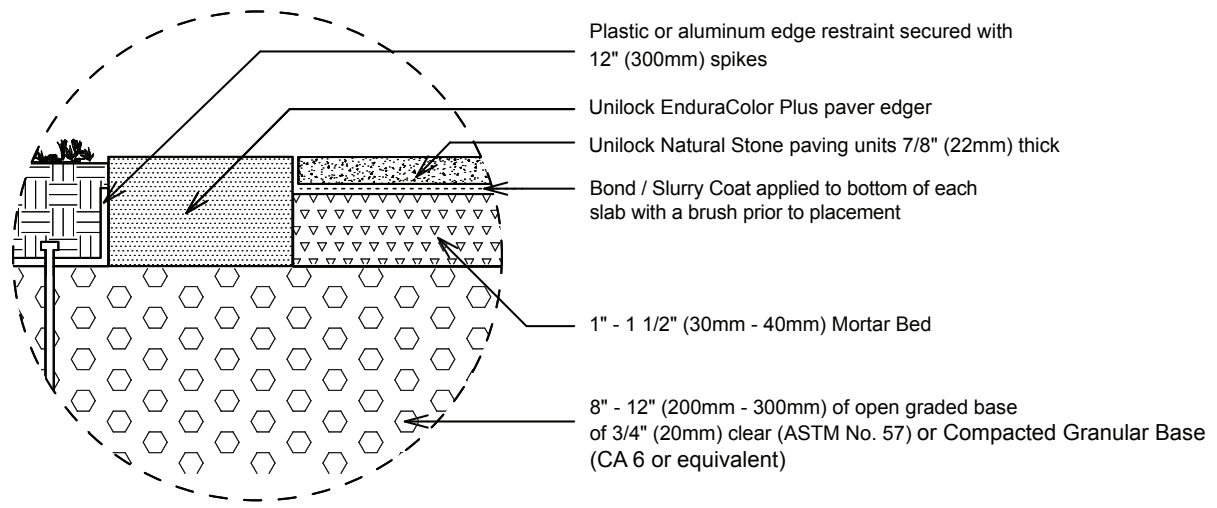

# NATURAL STONE

## INSTALLATION GUIDE



### CONCRETE OVERLAY

- FOR **GOOD** QUALITY CONCRETE PATIO, PORCH OR BALCONY SURFACES THAT ARE PROPERLY SLOPED

**Note:** when going over existing concrete, ensure that the surface of the slab is both cleaned and etched prior to adhering flagstone

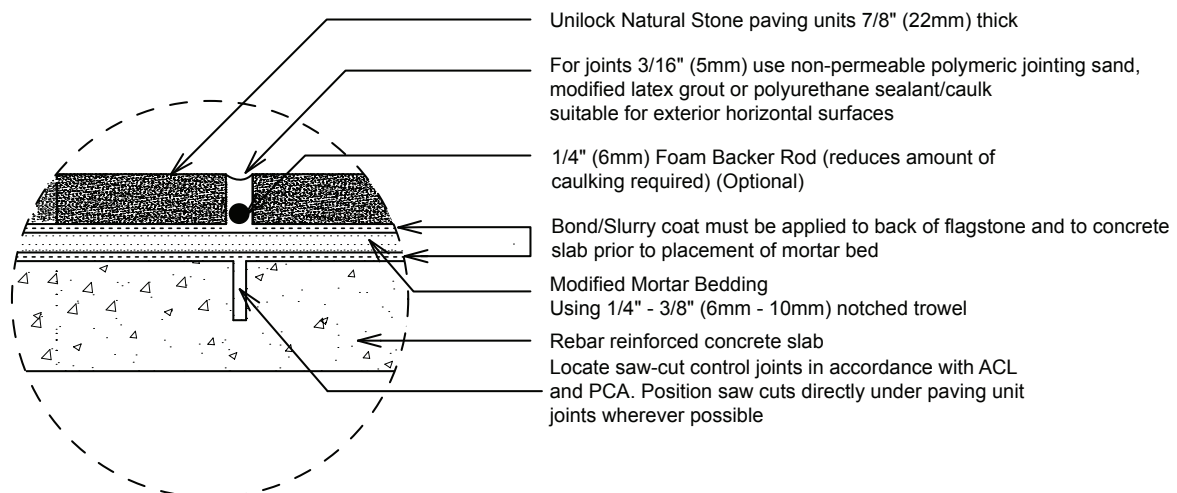
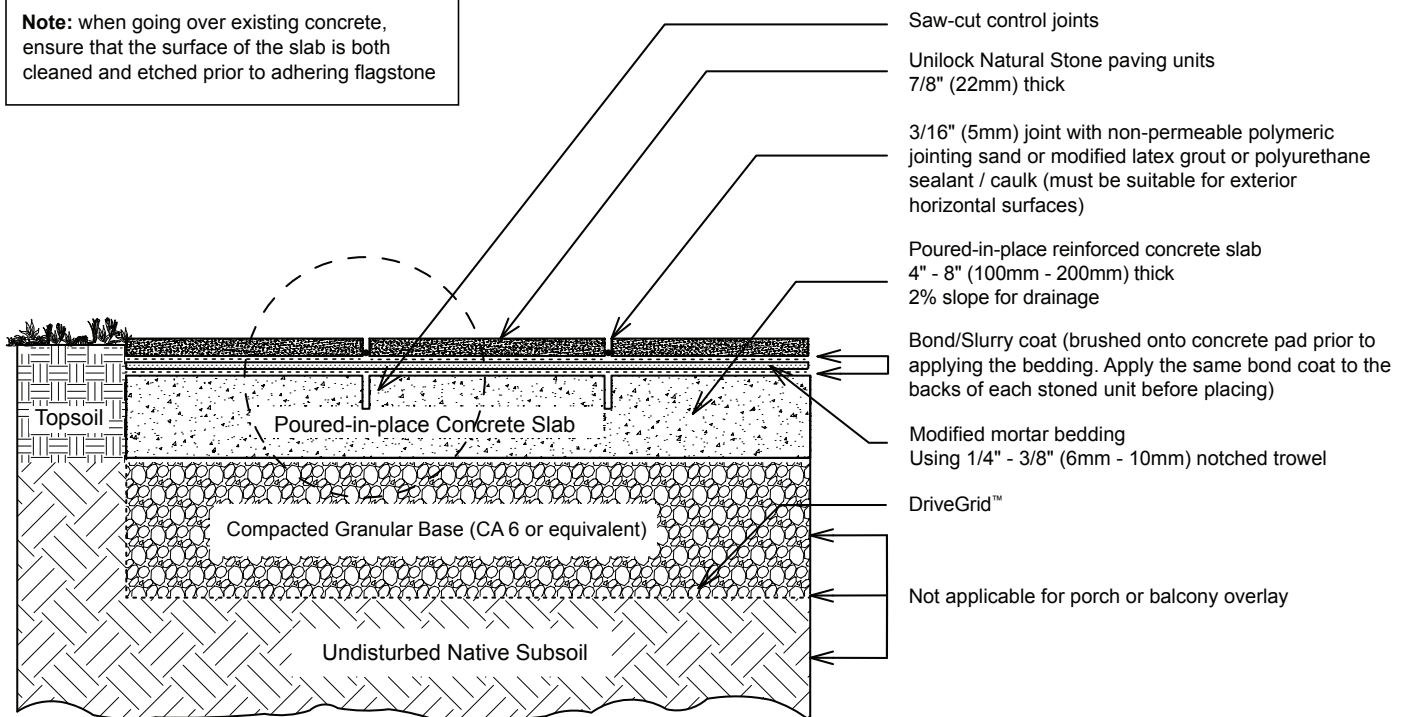

# NATURAL STONE

## INSTALLATION GUIDE



### CONCRETE OVERLAY

- FOR **POOR** QUALITY OR UNEVEN CONCRETE PATIOS, PORCHES OR BALCONY SURFACES

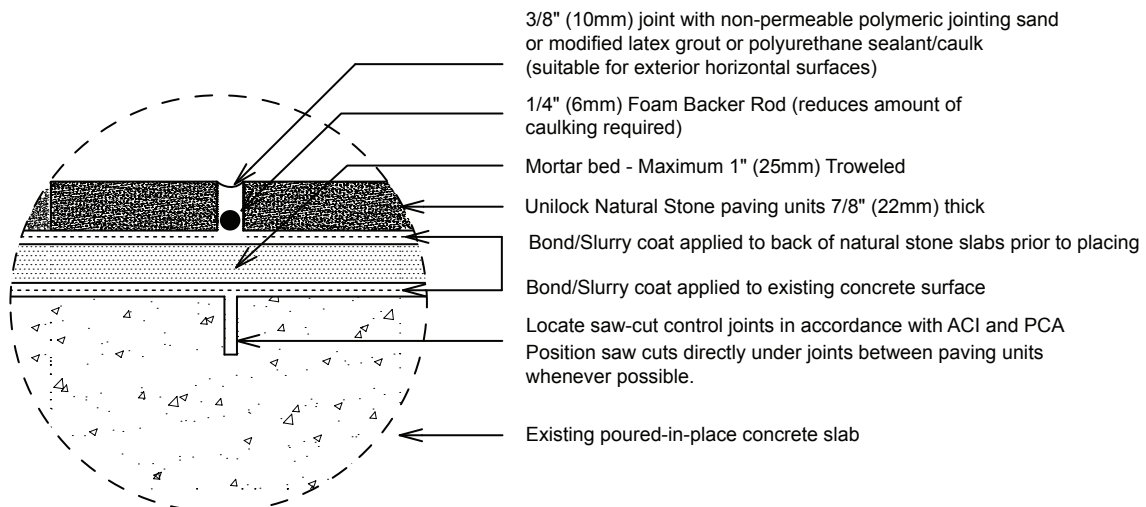
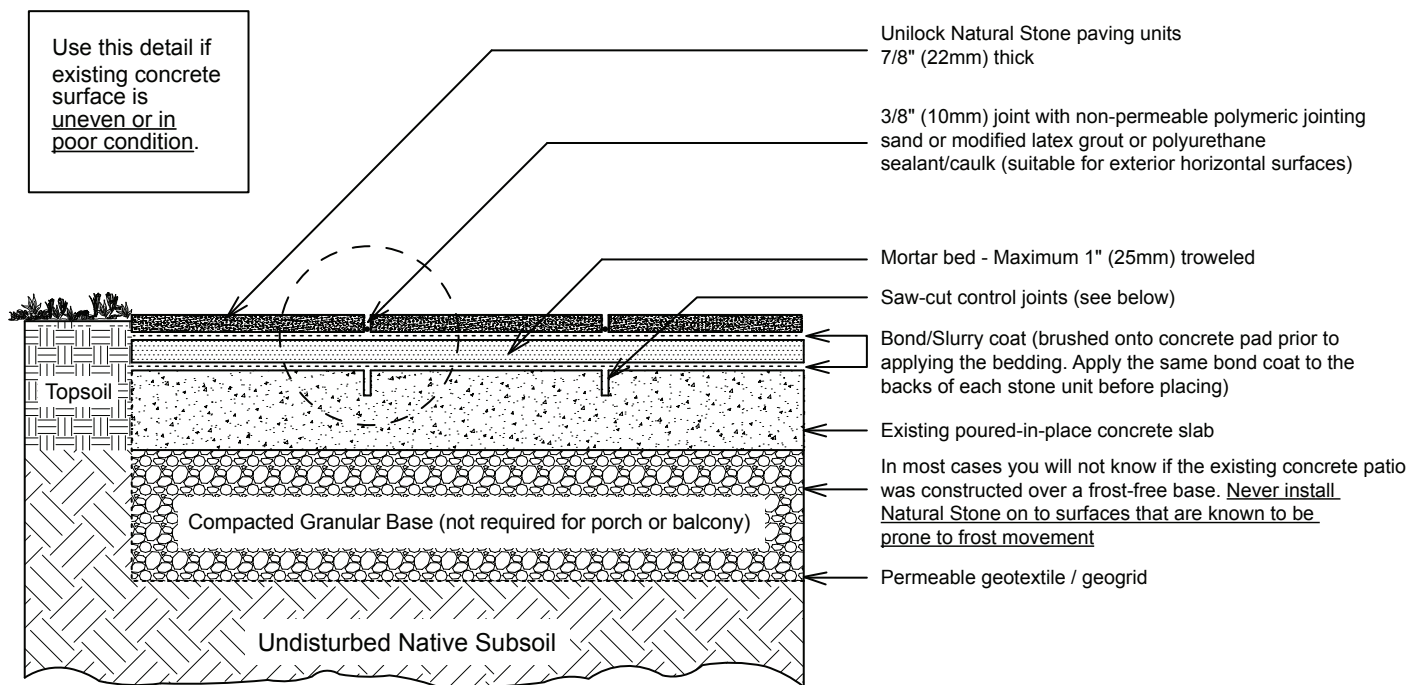

# NATURAL STONE

## INSTALLATION GUIDE



### WOOD DECK VENEER

- STRUCTURAL UNDERLAYMENT FOR ELEVATED DECKS

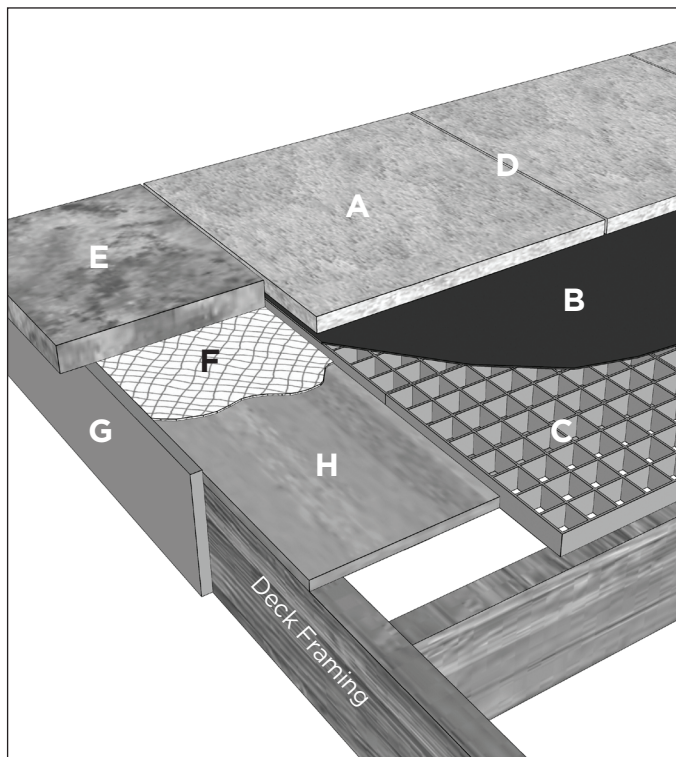
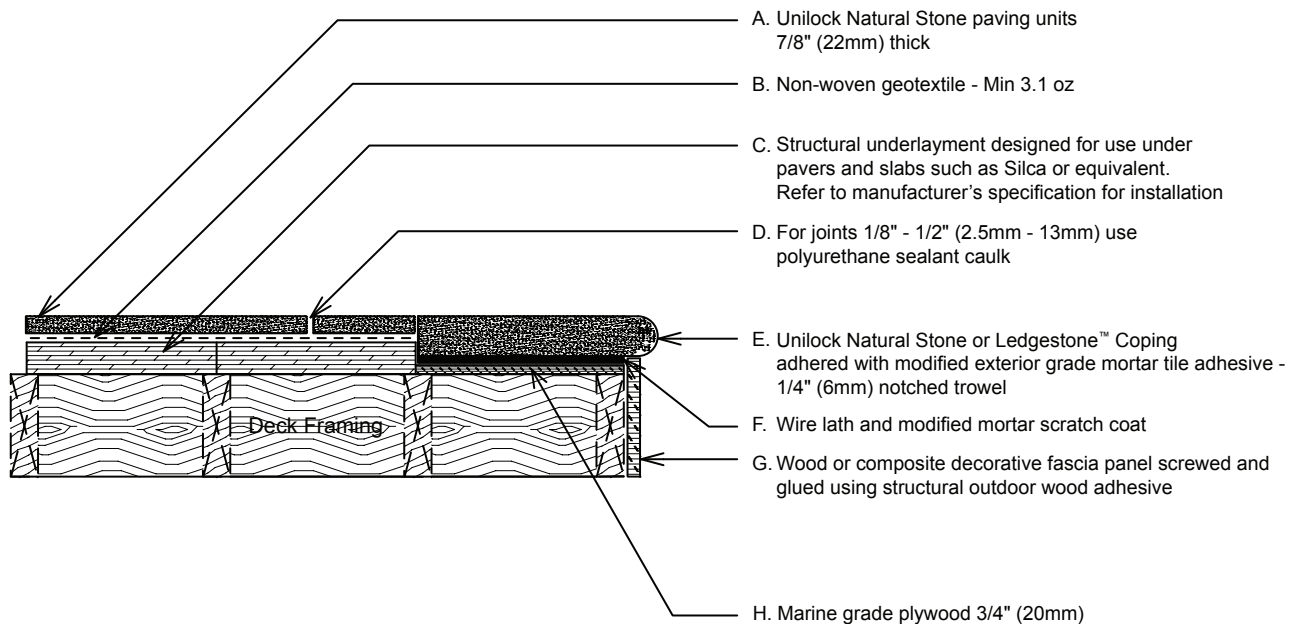

**Note:** The success of any Natural Stone installation over wood decking is entirely dependent on the decking structure. Always refer to underlayment manufacturer's specification for new or existing deck installations, and always follow local building codes.

To accommodate varying heights, structural underlayment can also be cut and recessed between joists. If joints between slabs are left open or permeable, water may penetrate and damage wood structure.

# NATURAL STONE

## INSTALLATION GUIDE



### WOOD DECK VENEER

#### - LOW PROFILE PEDESTAL

**NOTE:** The longevity of this installation method is directly related to the longevity of the wooden decking materials.

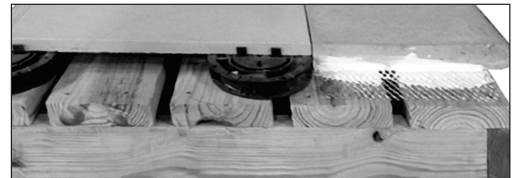
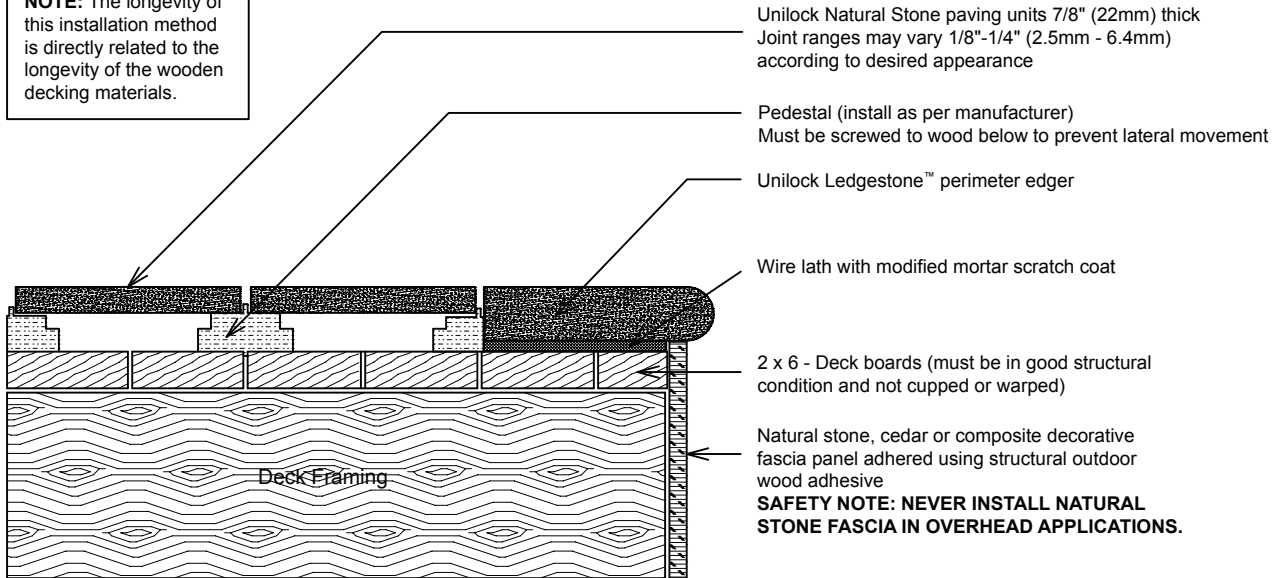

### PEDESTAL ON CONCRETE APPLICATION

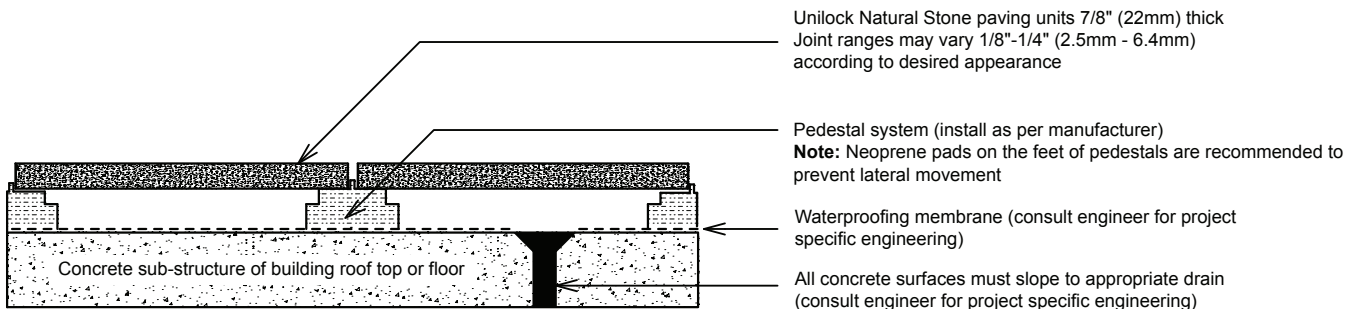

**NOTE:** Specific installation details may vary based on pedestal height, load-bearing requirements, safety standards and wind-lift. All roof top slab/pedestal installations must be engineered by a professional engineer.



# NATURAL STONE

## INSTALLATION GUIDE



### POOL COPING AND POOL DECK

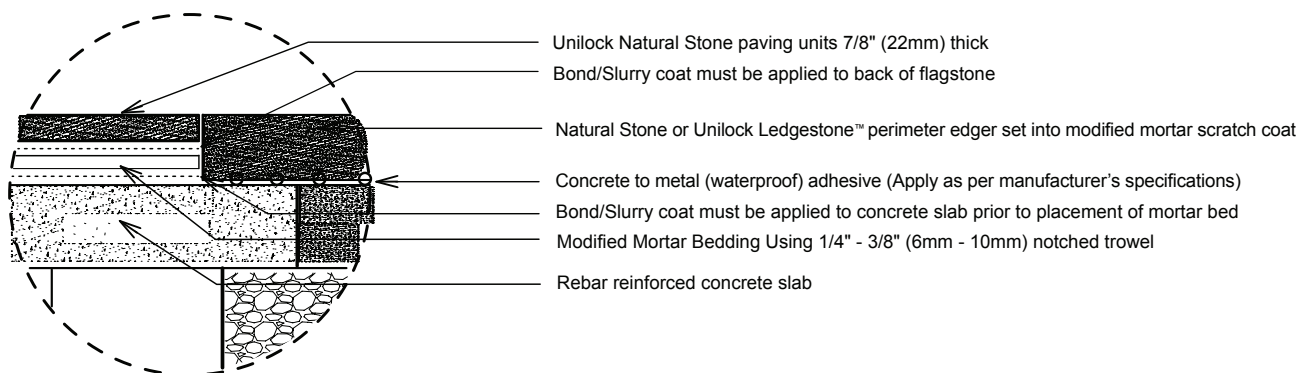
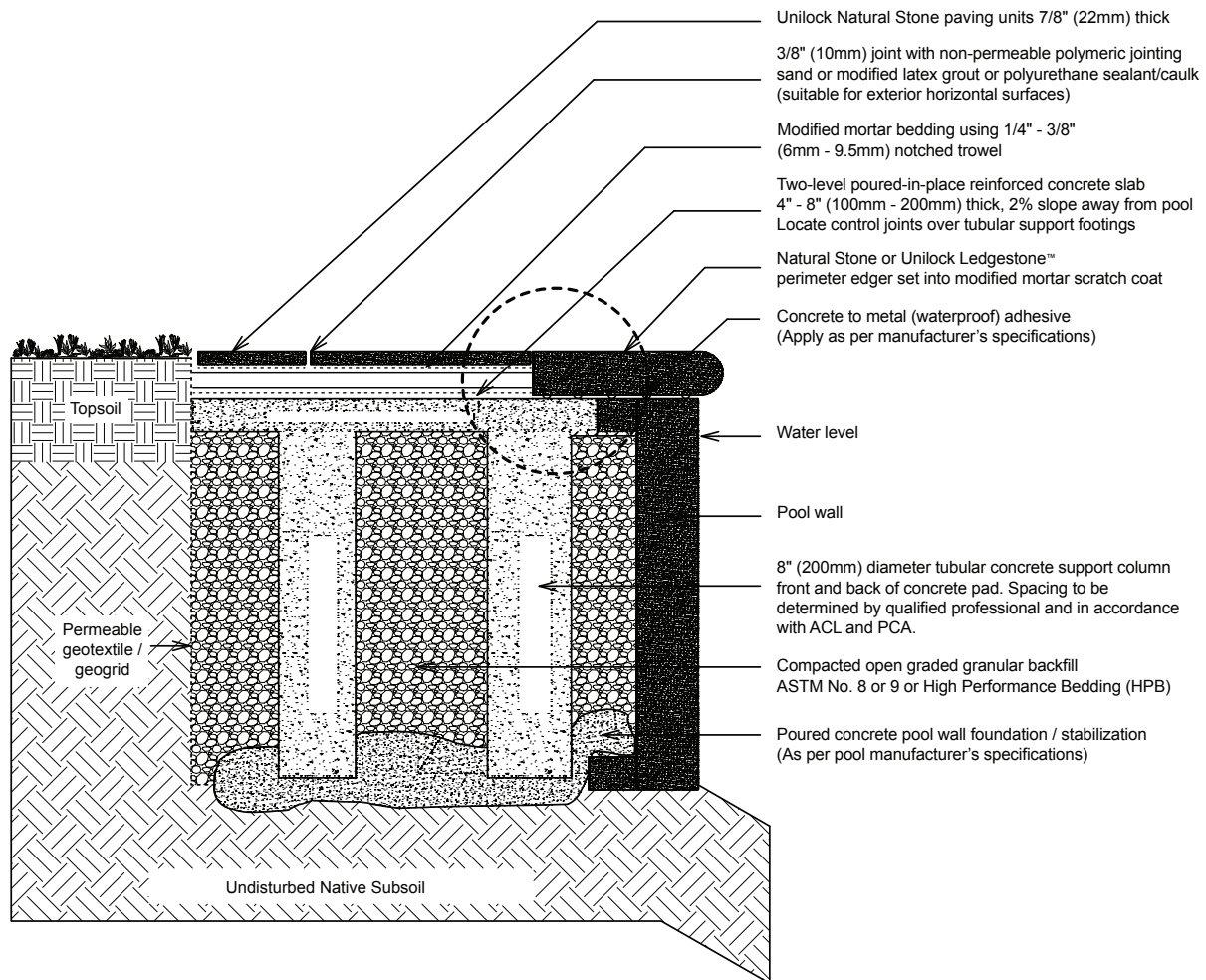

# NATURAL STONE

## INSTALLATION GUIDE



### UNI-CARE CLEANERS & SEALERS FOR NATURAL STONE

RECOMMENDED PRODUCTS FOR INSTALLING, CLEANING, ENHANCING & PROTECTING

#### AcidClean

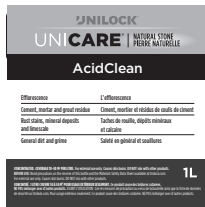

Removes mineral type residues including cement and mortar residues, efflorescence, rust stains, general dirt and grime, hard water scale (limestone), grout haze and grout films.

- Efflorescence
- Cement, mortar and grout residue
- Rust stains, mineral deposits and limescale
- General dirt and grime
- Concentrated. Coverage 10-50 M<sup>2</sup> per litre
- Available in 1L or 5L sizes

#### PowerClean

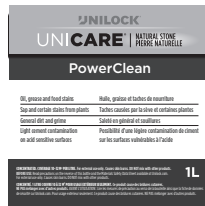

A high alkaline cleaner and degreaser. Can be used on natural stone, grout, ceramic, porcelain, terra cotta, quarry tiles, concrete, pavers and masonry.

- Oil, grease and food stains
- Sap and certain stains from plants
- General dirt and grime
- Light cement contamination on acid sensitive surfaces
- Concentrated. Coverage 10-32 M<sup>2</sup> per litre
- Available in 1L or 5L sizes

#### BioClean

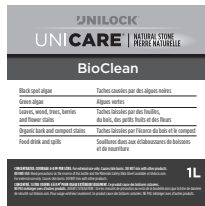

Removes organic type soiling such as black spot algae, green algae, staining from birds, berries, leaves, trees, bark, compost and colored food spillages such as tea, coffee, wine and popsicles, etc.

- Black spot algae, Green algae
- Leaves, wood, trees, berries and flower stains
- Organic bark and compost stains
- Food drink and spills
- Concentrated. Coverage 4-8 M<sup>2</sup> per litre
- Available in 1L or 5L sizes

#### NatMatte Sealer

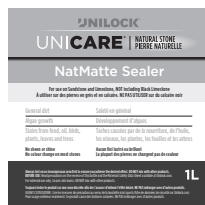

**For use on Sandstone and Limestone, NOT including Black Limestone.** NatMatte Sealer is an impregnating sealer, meaning it will leave no sheen, shine or surface coating of any kind. The product soaks into the stone surface which remains completely natural in appearance. NatMatte Sealer protects stone from staining from food, oil, grease, drinks, leaves, trees and general dirt. Helps to reduce algae growth.

- No sheen or shine
- No color change on most stones
- General dirt
- Algae growth
- Stains from food, oil, birds, plants, leaves and trees
- Available in 1L or 5L sizes

#### NatColorEnhance Sealer

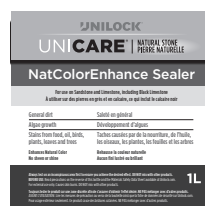

**For use on Sandstone and Limestone, including Black Limestone.** NatColorEnhance Sealer is an impregnating sealer, meaning it will leave no sheen, shine or surface coating of any kind. The product soaks into the stone surface which remains completely natural in appearance but enhances the natural color (gives a 'damp' look to the surface). NatColorEnhance Sealer protects stone from staining from food, oil, grease, drinks, leaves, trees and general dirt. Helps to reduce algae growth.

- Enhances Natural Color
- No sheen or shine
- General dirt
- Algae growth
- Stains from food, oil, birds, plants, leaves and trees
- Available in 1L or 5L sizes





— UNILOCK —

# NATURAL STONE

INSTALLATION GUIDE

**DISCLAIMER**

The cross sections and diagrams included in this document are intended for the preliminary design and installation of natural stone paving units from Unilock. Unilock cannot guarantee and will not be held responsible for any installation failure and accepts no liability for the improper use of these details.

It is the installer's responsibility to ensure that all site and structural factors are properly addressed and a structural engineer may be required to provide site-specific engineering and installation specifications.

**NOTE:** Unilock cannot guarantee the tensile strength of natural stone paving units for pedestal applications or when substructures shift or deteriorate.

UNILOCK.COM | 1-800-UNILOCK

©2018 Hengestone Holdings, Inc.